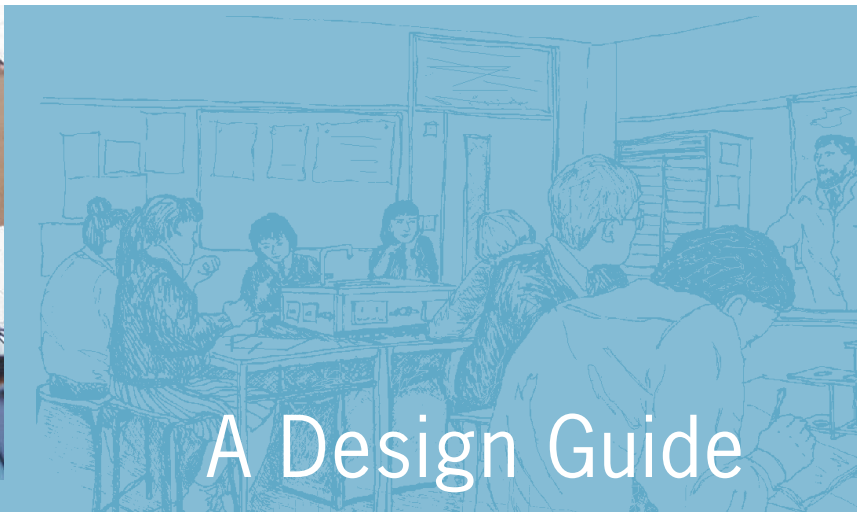


# SCIENCE ACCOMMODATION in SECONDARY SCHOOLS



A Design Guide



Schools Building and Design Unit (SBDU)

# Contents

<b>Introduction</b>	<b>3</b>
<b>Section 1:</b> Planning the Suite	<b>5</b>
<b>Section 2:</b> The Laboratory	<b>10</b>
<b>Section 3:</b> Support Spaces	<b>33</b>
<b>Section 4:</b> Furniture, Equipment and Finishes	<b>38</b>
<b>Section 5:</b> Environmental Design and Services	<b>48</b>
<b>References</b>	<b>51</b>
<b>Key to symbols</b>	<b>54</b>

---

## **Acknowledgements**

This document is a revised version of Building Bulletin 80 published in 1999. It excludes the original sections 6 and 7. This revised version was prepared by:

Lucy Watson, Alison Wadsworth and Richard Daniels,  
Schools Building and Design Unit (SBDU), Department for Education and Skills

In consultation with:

John Lawrence, Deputy Chief Executive, Association for Science Education

Andy Piggott, Project Officer for Laboratory Design for Teaching and Learning, Association for Science Education

Dr Peter Borrows, Director, Consortium of Local Education Authorities for the Provision of Science Services

Ian Richardson HMI, Ofsted

© Crown copyright 2004

Extracts from this document may be reproduced for non-commercial or training purposes on the condition that the source is acknowledged.

# Introduction

This document offers guidance to those concerned with the provision of science accommodation, whether through new construction or the adaptation of existing buildings. It is aimed at teachers, governors, local education authority advisers, building professionals and others who may be involved in the briefing and design process.

The document is based on Building Bulletin 80 'Science Accommodation in Secondary Schools'<sup>1</sup> and has been updated to reflect current thinking on secondary school design and on science education. Key issues that influenced the changes to the laboratory layouts were greater inclusion of pupils with special educational needs and increased use of ICT. This is a shorter version of the original Building Bulletin and it excludes case study and cost sections.

Science is a core National Curriculum subject at all key stages (KS). Post-16 courses are widely taught in schools. Exciting and relevant practical activities are an essential part of science learning and the science curriculum requires practical work at all levels. Most lessons contain a mixture of practical and non-practical activities. The range of activities includes: whole class practical demonstrations, presentation and discussion; small group experimental work; discussion and research. The use of ICT is increasing rapidly - for research, presentations and data logging and sometimes for simulating experiments that are too expensive or time consuming to carry out 'live' in a school.

In order to meet the needs of a full range of teaching and learning activities, science is normally taught in serviced laboratories. This gives teachers flexibility to plan and deliver good teaching and learning activities.

The learning environment makes an important contribution to staff recruitment and retention and pupils' enjoyment of science. A recent survey of 1000 11 to 16 year old pupils found that poorly lit spaces with out-dated furniture were one of the factors contributing to pupils' dislike of science.<sup>2</sup> The Building Schools for the Future initiative (BSF)<sup>3</sup> gives an opportunity to provide suitable and attractive spaces that stimulate pupils' learning.

This document will help to ensure appropriate accommodation is provided but it is not meant to be prescriptive. The planning diagrams and room layouts illustrate key principles; they are not the only solutions. The amount of curriculum time spent on science, the way in which the subject is delivered and the whole school's approach to learning will all need to be reflected in the accommodation brief. The design solution must be flexible and adaptable enough to take account of both current and future needs.

The accommodation needs of science should be considered in the context of the whole school development plan and it is important that science staff and pupils are consulted about their teaching and learning needs before an accommodation brief is drawn up. It is recommended that the brief is developed in partnership with local education authority (or other) specialist advisers and building professionals. It is important to set planning targets to suit available resources and to look for value for money in all solutions.

The software 'Laboratory Design for Teaching and Learning' which is available at [www.ase.org.uk/ldtl/](http://www.ase.org.uk/ldtl/) includes a useful planning tool for use when developing a brief. It also contains guidance which provides a useful complement to this publication.

<sup>1</sup> Building Bulletin 80, 'Science Accommodation in Secondary Schools' revised 1999 published by TSO.

<sup>2</sup> This 2003 survey was part of the 'Science Studios for the Future' project looking at the facilities that will meet the needs of students and teachers into the future, jointly promoted by the Innovation Unit at the DfES and Bedfordshire LEA.

<sup>3</sup> The BSF programme aims to replace all secondary schools over a ten to fifteen year period from 2005-6, subject to future public spending decisions. Capital funding has increased significantly recently and will increase to £5bn in 2005-6.

There are no specific middle school plans illustrated in this document although part of the KS3 curriculum will be taught in these schools. However, many of the planning principles described in Section 1 and the detailed information on servicing and furniture systems in other sections will apply.

The information in this publication begins with a broad outline of accommodation requirements, followed by more detailed guidance; a summary of the content is given here.

**Section 1: Planning the Suite** outlines the range of spaces usually required and looks at a range of generic departmental plans.

**Section 2: The Laboratory** looks at the link between activities and facilities. It provides guidance on services distribution, servicing systems and space planning. A number of furnished plans are illustrated.

**Section 3: Support Spaces** provides guidance on the teaching and non-teaching spaces supporting the laboratories.

**Section 4: Furniture, Equipment and Finishes** covers items used in the laboratory and preparation room, complementing Sections 2 and 3. It also provides guidance on surface finishes.

**Section 5: Environmental Design and Services** gives general guidance on lighting, heating and ventilation and on services installations.

A list of references provides a useful guide to further information.

# Section 1: Planning the Suite

This section outlines the main points to be considered when planning a suite of science spaces. It looks at the number, size and type of teaching and non-teaching space and a series of generic plan types indicates the key relationships between spaces.

The range of spaces in a science department is likely to include laboratories, preparation and storage space and staff office(s). There may also be supplementary teaching and non-teaching areas. The guidance in this section refers mainly to individual laboratories in enclosed rooms, reflecting the most typical pattern in existing schools. Alternative arrangements are possible as long as safety and environmental (including acoustic) requirements are met.

## Teaching Spaces

The science curriculum requires practical work at all levels and in order to give teachers greater flexibility in lesson planning, science is normally taught in laboratories. Most lessons contain a mixture of activities, which may include presentation, discussion, research or carrying out practical experiments. The activities that take place and the facilities they generate are described in more detail in Section 2. ICT, in the form of desktop or laptop computers and interactive whiteboards, is used increasingly for investigatory work, data logging, presentations and simulating experiments.

## Number of Laboratories

Whether a new science block is being considered or existing accommodation adapted, the school's current and planned curricular, timetabling and staffing arrangements will need to be analysed in order to assess the number of laboratories that are required.

Group sizes and the amount of curriculum time spent on science will vary from school to school. If groups are smaller, more laboratories will be needed

but they can be correspondingly smaller. The curriculum time per pupil (as a percentage of the whole) may range from 10 - 15% at KS3 (the typical average is 12%) and 10 - 30% at KS4 with a current average of 20%. Post-16 courses take 20% or 40% depending on the type of course.

Figure 1/1 shows two tables. The first shows the number of spaces that are generated by a typical 11 to 16 curriculum model, for a range of school sizes. The second table shows the number of spaces that are generated by adding different post-16 curriculum models to the typical 11 to 16 one. Model A reflects an average take-up of science which generates one group per science subject with an extra group in the larger schools. Model B reflects a post-16 curriculum which includes a vocational course. The 11-18 models assume a 'home grown' sixth form of average size. If post-16 numbers are significantly larger (perhaps due to intake at year 12) a larger number of post-16 spaces (calculated) will be applicable.

Figure 1/1 shows the average frequency of use of the spaces, that is timetabled use compared to availability. The higher the figure, the more efficiently a space is being used. Schools will probably find it difficult to achieve a frequency of use higher than around 85% for science because of the complexities of timetabling and the need for technicians to service laboratories. The models shown here are therefore based on a maximum frequency of use of 85-86%. Alternative figures with 87-90% frequency of use are shown reflecting what can be achieved. The table shows that the post-16 periods generate one additional space in Model A and 2 or 3 additional spaces in Model B. Providing three dedicated sixth form science laboratories is, in most cases, unnecessary. See 'Size of Laboratory' below for further discussion on this.

## Section 1: Planning the Suite

**Figure 1/1**

Numbers of Spaces for a Typical Range of Schools

Note

12% average curriculum time KS3, 20% average curriculum time KS4.

FE groups Y7, FE+1 groups Y8 & 9, max group size 24 Y10 & 11

**TABLE 1: 11-16 model**

	<b>600 4fe</b>	<b>750 5fe</b>	<b>900 6fe</b>	<b>1050 7fe</b>	<b>1200 8fe</b>	<b>1350 9fe</b>
KS3 & 4 TPs	92	121	130	159	178	207
number spaces (calculated)	3.68	4.84	5.2	6.36	7.12	8.28
<b>number spaces (rounded)<sup>1</sup></b>	<b>5</b>	<b>6</b>	<b>7</b>	<b>8</b>	<b>9</b>	<b>10</b>
frequency of use	74%	81%	74%	80%	79%	83%
					or 8 @ 89%	

**TABLE 2: 11-18 models (11-16 figures based on Table 1)**

Note

One group each science subject 4fe-6fe, plus extra group 7fe-8fe (20% curriculum time)

<b>A</b>	<b>600 4fe</b>	<b>750 5fe</b>	<b>900 6fe</b>	<b>1050 7fe</b>	<b>1200 8fe</b>	<b>1350 9fe</b>
post-16 TPs	30	30	30	40	40	40
post-16 spaces (calculated)	1.2	1.2	1.2	1.6	1.6	1.6
total number spaces (calculated)	4.88	6.08	6.8	7.96	8.72	9.88
<b>number spaces (rounded)<sup>1</sup></b>	<b>6</b>	<b>7</b>	<b>8</b>	<b>10</b>	<b>11</b>	<b>12</b>
frequency of use	81%	86%	85%	80%	79%	82%
				or 9 @ 88%	or 19 @ 87%	
<b>B</b>	<b>600 4fe</b>	<b>750 5fe</b>	<b>900 6fe</b>	<b>1050 7fe</b>	<b>1200 8fe</b>	<b>1350 9fe</b>
post-16 TPs	50	50	50	60	60	60
post-16 spaces (calculated)	2	2	2	2.4	2.4	2.4
total number spaces (calculated)	5.68	6.84	7.6	8.76	9.52	10.68
<b>number spaces (rounded)<sup>1</sup></b>	<b>7</b>	<b>8</b>	<b>9</b>	<b>11</b>	<b>12</b>	<b>13</b>
frequency/use	81%	86%	84%	80%	79%	82%
				or 10 @ 88%	or 11 @ 87%	

Note

As model A plus a vocational group (40% curriculum time)

### KEY

TPs = teaching periods

fe = forms of entry

KS = key stage

Y = year

### Notes

<sup>1</sup> Where rounding up to the nearest whole number will result in a frequency of use greater than 90%, the next highest number of rooms is given.

## Size of Laboratory

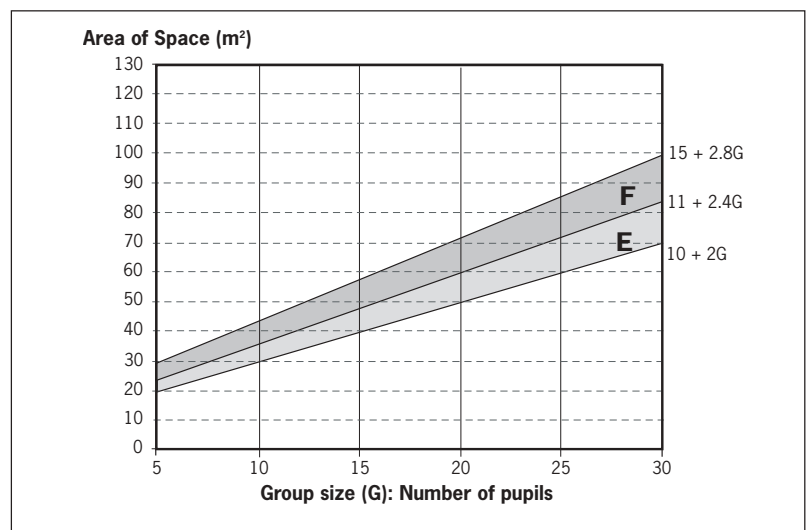
The size of a laboratory will depend on the maximum expected group size rather than the calculated average. The graph in Figure 1/2 shows suggested area ranges according to group size.<sup>2</sup> A range of 83- 99m<sup>2</sup> (zone F) is recommended for a group of 30 KS 3/4 pupils. Laboratories from Zone E (70-83 m<sup>2</sup> for up to 30 KS 3/4 pupils) may be possible but will limit the activities and choice of furniture used.<sup>3</sup> The range of activities being undertaken, the level of storage kept in the laboratory, the number of pupils with special needs, and the type of furniture system used can all affect area requirements. Section 2 provides further information on the size and shape of the laboratory and illustrates a number of spaces of 90m<sup>2</sup> for a maximum group size of 30 pupils.

Post-16 students need more area than younger pupils mainly because of the space needed for experimental work which is generally done individually rather than in pairs, often using more equipment. They may also need to set up a long term experiment. A space of 90m<sup>2</sup> which is suitable for 30 KS3 pupils will accommodate up to 20 post-16 students. There may be more non-practical work carried out at post-16 level some of which could take place in a general teaching classroom, although this would reduce flexibility for timetabling.

If all the laboratories in the suite are the same size, and able to accommodate the likely maximum group size schools will be able to timetable their spaces more flexibly. These spaces can be used by smaller post-16 groups. It may be useful to designate one space in the suite for the older pupils so that experiments can be set up and left undisturbed. However, in some situations, for example where a school has enough small post-16 science groups to justify the arrangement it may be appropriate to provide some smaller specialist laboratories.

## Other Learning Spaces

It is useful to have somewhere for post- 16 students to set up long term experiments. This may be in a part of a



**Figure 1/2**  
Area range for science according to group size

laboratory (see above and Section 2) or in a small science project room. Some schools may have supplementary resource areas such as a greenhouse or microbiology room. Externally an environmental area may be provided, possibly used in conjunction with a greenhouse.

## Non-Teaching Support Spaces

Preparation and storage areas are needed to support the teaching spaces. A total area of 0.4 – 0.5m<sup>2</sup> per workplace (a figure based on an analysis of a number of existing schools) can be used as a guide. The upper end of the range may be needed where there are post-16 students to accommodate additional or more bulky resources. If a greenhouse is provided, there should be somewhere secure and convenient to store equipment. Where laboratories are dispersed or on two floors this figure may need to be increased to allow for the inevitable duplication of some resources.

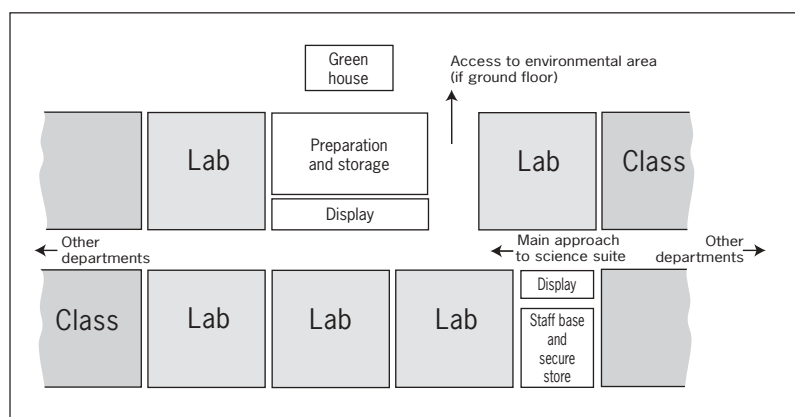
Staff will need somewhere to hold meetings and do preparation work. This is usually provided by a departmental staff base which can also be used for the secure storage of paperwork such as pupils' records. It may also double as a local social base depending on the schools' arrangements for staff rooms throughout the school.

### Notes

<sup>2</sup> The graph is based on the formulae shown alongside, where G = group size. It is extracted from Building Bulletin 98 (BB98), Briefing Framework for Secondary Schools.

<sup>3</sup> In the net capacity assessment method, a light practical space of more than 83m<sup>2</sup> gives 30 workplaces.

## Section 1: Planning the Suite



**Figure 1/3**  
Linear Plan

### Planning Principles

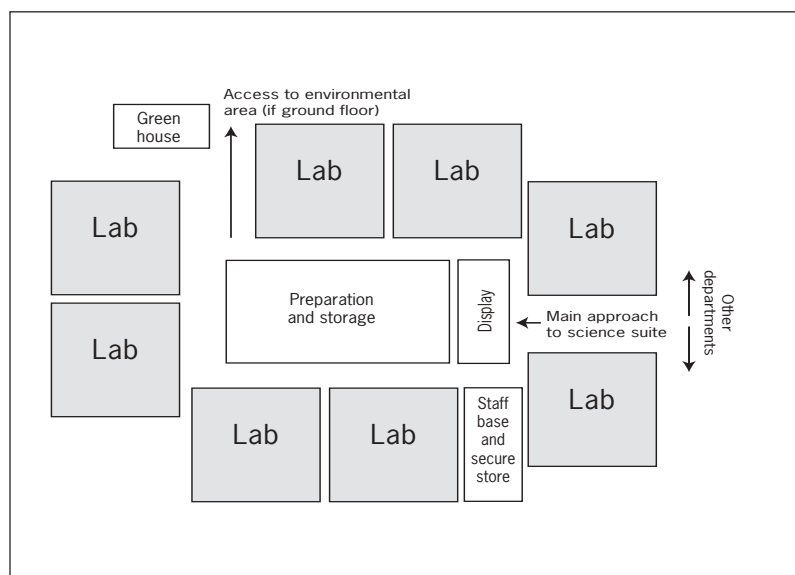
Figures 1/3 to 1/6 show four plan types: linear; grouped around a preparation room; grouped around a courtyard; and linear on two floors. These reflect typical organisational patterns, each one conforming to the following principles which aim to provide an efficient and integrated suite of spaces.

#### Laboratories are grouped together.

This enables common resources to be shared, and gives equal access to support spaces.

**There is only one preparation area for each floor of laboratories.** This provides a more economical use of space, equipment and technicians' time. If a preparation room is centrally positioned, travel distances to each laboratory are minimised.

**Figure 1/4**  
Central Preparation Room



**The departmental base is centrally located.** This provides ease of access for staff. Whatever the plan type, circulation routes should allow for the adequate movement of equipment, trolleys and people (including those using wheelchairs).

**There is easy access to a sheltered outside space** that can provide an environmental area and/or a greenhouse. If laboratories are on an upper floor it may still be possible to make use of a terraced area.

The key features of the four generic plan types are outlined below. These diagrams are relevant to a variety of approaches. Whatever planning solution it is important that the possibility of future adaptation is considered and that there is adequate circulation to allow free movement of staff and pupils including those with disabilities.

### Linear Plan (Figure 1/3)

This plan is more suited to a school with up to six laboratories where they are close enough together to feel like a suite and technicians can reach the rooms easily. For a school with more than seven laboratories the distance between the preparation room and some of the laboratories becomes inconvenient and the suite may be too dispersed. The advantage of this plan type is that circulation is efficient because laboratories are on two sides of the corridor. It can also facilitate links with adjoining departments, allowing resources to be shared; for example, with design and technology. Staff and display areas can also be shared.

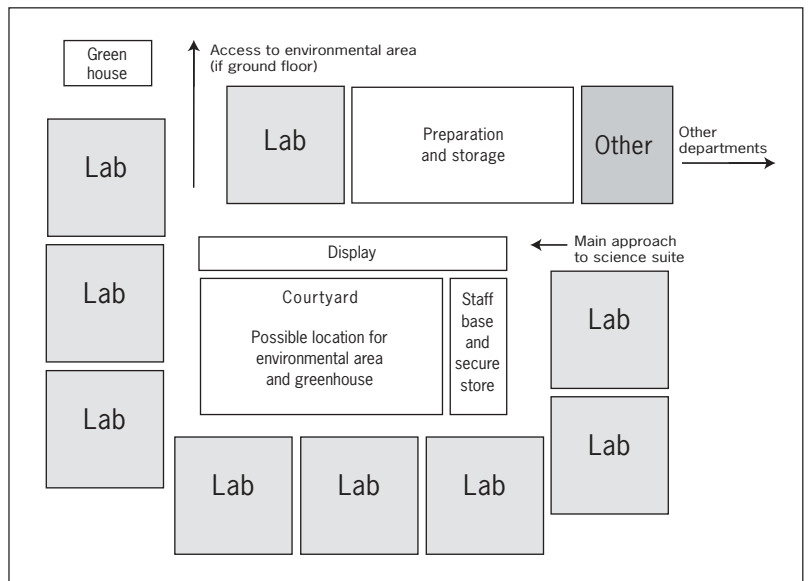
### Central Preparation room (Figure 1/4)

This plan is most suitable for schools with more than seven laboratories. It is convenient for the technicians because the preparation room is central to the suite, but there is no view out and in a two storey building there may be no daylight. The disposition of the plan

makes the suite easy to define but it may be less easy to establish links with other departments or to expand in the future.

### Central Courtyard (Figure 1/5)

This plan is less compact than the previous one with greater distances from preparation room to laboratory. The technicians enjoy a view of the outside and the enclosed and secure courtyard can be used for some practical activities, and could accommodate a greenhouse or environmental area, becoming an integral part of the suite of teaching spaces.



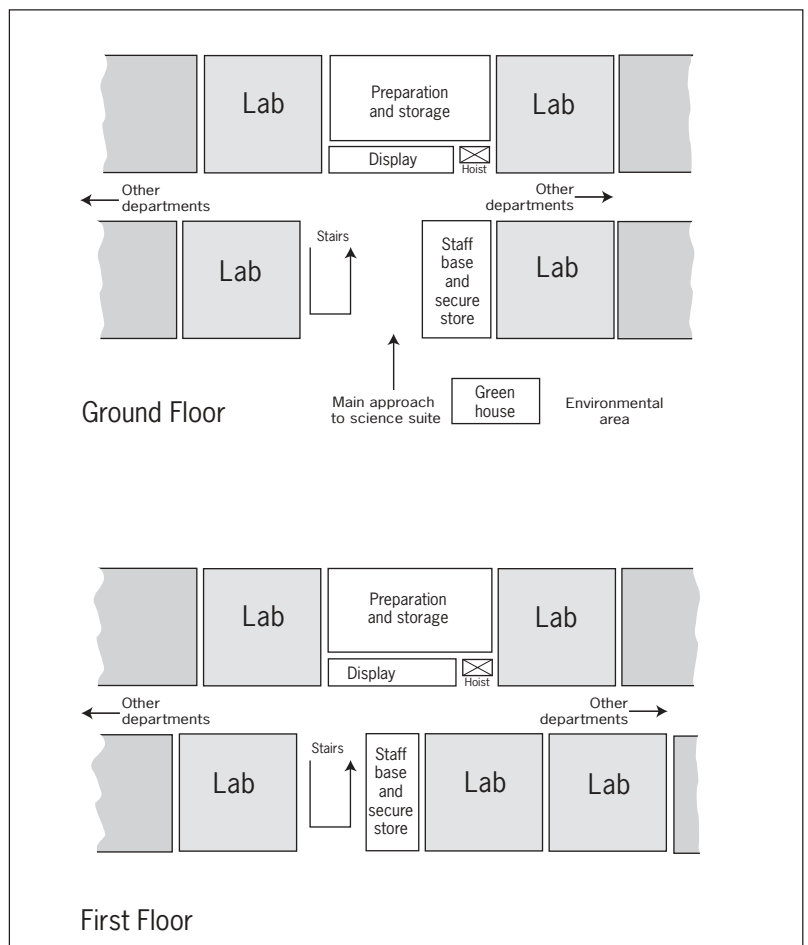
**Figure 1/5**  
Central Courtyard

### Linear On Two Floors (Figure 1/6)

Extending the suite on to two floors may be the best solution in some buildings, and it does share some of the advantages of the linear plan (ease of inter-departmental links and ease of extension). In a large school it may also help to break down the scale of the suite.

The main disadvantage of this plan is that preparation and storage facilities are divided between the floors. A lift, which would be required for disabled access, could also be used for transporting heavy pieces of equipment such as gas cylinders (on trolleys). However, if a lift is not conveniently placed, a hoist may be required.

**Figure 1/6**  
Linear On Two Floors



# Section 2: The Laboratory

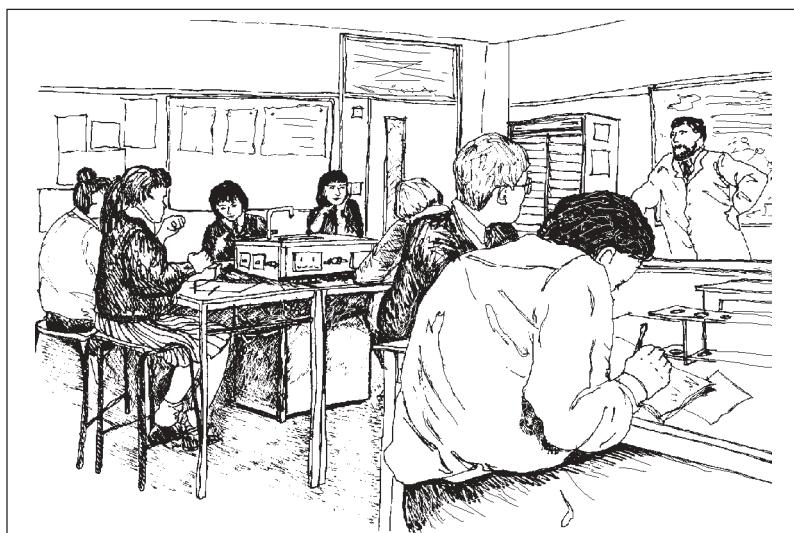
A laboratory should be flexible enough to respond to a wide and varying range of activities. The size of the space, the method of distributing services, and the choice of furniture system will all affect the way in which it can be used.

This section provides guidance on all the main aspects of planning a laboratory. It is divided into five parts.

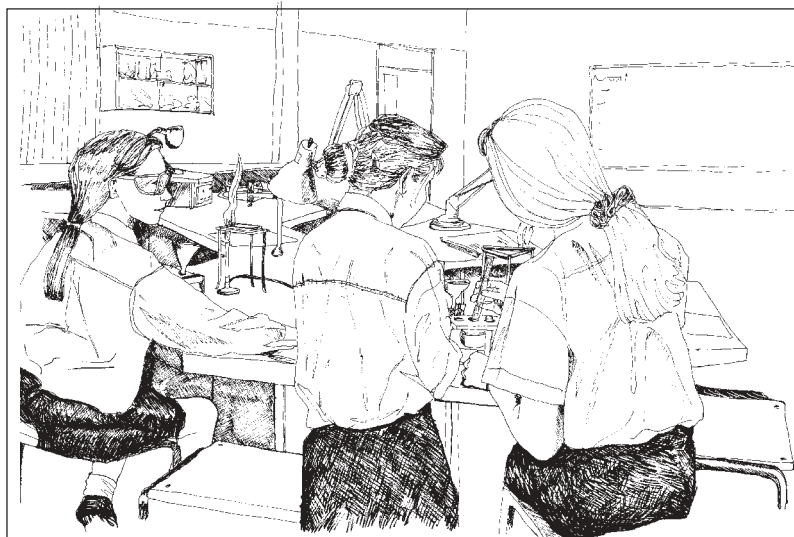
- Activities in the Laboratory.
- The Size and Shape of the Laboratory.
- A Planning Strategy.
- Services Distribution.
- Serviced Systems.

This is followed by examples of furnished room layouts using a variety of serviced systems.

**Figure 2/1**  
Whole class discussion



**Figure 2/2a**  
Small group practical work



## Activities in the Laboratory

There are certain basic activities common to all areas of science which may be identified as having an effect on the design of the laboratory. These activities can be categorised into three main areas.

- Whole class activities.
- Individual or small group practical activities.
- Individual or small group non-practical activities.

These activities and the facilities generally associated with them are described below.

### Whole class activities (Figure 2/1)

Activities that take place as a whole class include discussion, presentation (either by a teacher or pupil) and demonstration of an experiment (real or simulated). Some kind of whole class activity is likely at the beginning and end of a lesson even where the remainder of the time is spent working in smaller groups (see below).

The following facilities are likely to be needed:

- access to a variety of media including video, overhead projector, interactive whiteboard or remote portable tablet;
- somewhere for pupils to take notes;
- teacher's access to a serviced unit and possibly a fume cupboard when demonstrating a live experiment;
- space for all pupils to gather around and see clearly a demonstration at the teacher's (or other serviced) area.

All pupils including those in wheelchairs should be able to see the whiteboard or video screen clearly and ideally get to the whiteboard easily to allow them to fully participate.

### Individual or small group activities: practical (Figure 2/2a)

Increased scientific investigation by pupils is now commonplace in laboratories. Although some will be simulated, pupils will carry out experiments, either in small groups of two or three or (most commonly at post-16 level) individually. This will require:

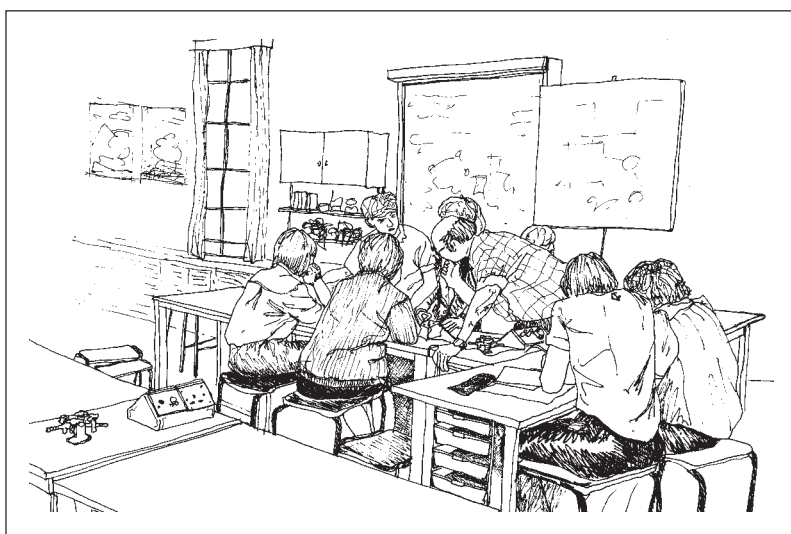
- access to a full range of services;
- sufficient space for pupils to work safely at serviced units and for teachers to get to the pupils for observation or in the case of an emergency;
- ready access to a range of basic resources, such as bunsen burners, mats and tripods;
- access to a computer to log and analyse data during experiments or to carry out virtual experiments.

### Individual or small group activities: non-practical (Figure 2/2b)

Non-practical activities can include information gathering, planning or writing up experiments and small group discussion. Pupils may work individually or in groups of two, three or sometimes up to eight. These activities will require:

- table space for writing up notes or using text books;
- layout arrangement which allows a small group of pupils to gather together for discussion and presentation;
- access to networked computers for retrieving information or for writing up reports;
- sufficient space to allow teachers to circulate amongst different groups of pupils.

Occasionally a teacher may address a small group rather than the whole class for briefing, demonstration or discussion. Sufficient area around pupils' serviced units should therefore be provided with the option of an additional whiteboard away from the teacher's area a distinct advantage.



**Figure 2/2b**  
Small group non-practical work.

### Use of ICT

Access to computers can be provided in various ways including:

- a bank of laptops per lab;
- a run of desktop computers at the back of the lab;
- a computer resource bay in the science suite (here pupils would be required to leave the laboratory without supervision);
- a booked ICT classroom shared with the rest of the school.

Laptops have the advantage that they are portable and require less space than desktops. They can be used anywhere for non-practical work and can be positioned next to serviced units for activities such as data logging during an experiment. It may be necessary to consider networking outlets in serviced units for information retrieval. Current concerns about robustness and high cost may be addressed as technology develops. Some schools prefer desktops, however they are often difficult to position next to experiments unless they are on trolleys and wheeled up to the serviced units. Space may also restrict the numbers of desktops that can fit in a standard sized lab. This may not be practical for a class of 30 all wishing to download data or access information at the same time.

### The size and shape of the laboratory

Figure 1/2 in Section 1 shows an area range of 83-99m<sup>2</sup> (Zone F) for a group of 30 KS3/4 pupils. An area from the middle of this range will allow a class to undertake the activities identified above in safety and comfort and takes account of the needs of pupils in wheelchairs. This area will be suitable for up to around 20 post 16 students including 1 or 2 fume cupboards, assuming they are ducted. An area from the upper end of the range may be appropriate where a small central preparation area necessitates an increase in local storage (although this is not recommended in a new building), where the quantity of equipment is greater than average or where a bank of desktop computers is provided at the back of the room. An area from the upper end may also be needed for a sixth form group bigger than 20 if a significant amount of large additional equipment is required (eg 2 or 3 fume cupboards).

At the lower end of the range the choice of servicing system and careful planning of the layout becomes more critical and compromises may have to be made in the provision of equipment. As the size of the laboratory reduces, it becomes increasingly important to ensure careful supervision of practical work to maintain safe working practices. A laboratory of

70-83m<sup>2</sup> (Zone E in Figure 1/2) may accommodate 30 KS3/4 pupils but there will be a significant reduction in the provision of furniture and equipment and there may be, as a result, a limitation in the range of activities taking place.

All the laboratories shown in this section (Figures 2/11 to 2/25) are 90m<sup>2</sup> for up to 30 KS3/4 pupils (the middle of Zone F).

The shape of the space is almost as important as its size. A simple rectangular shape allows for flexibility of layout and enables good supervision and sightlines. Rooms that are too long and narrow are difficult to plan; viewing distances may be too long or viewing angles too wide (see Figure 2/3). Pupils may find it difficult to hear the teacher from the back of a very long room. In a space of 90m<sup>2</sup>, a depth of between 8.5m and 9m (i.e. proportions from 1:0.8 to 1:1.1) suits a variety of furniture systems and avoids most of the problems listed above. Particular consideration must be given to ventilation and lighting in deeper spaces (See section 5).

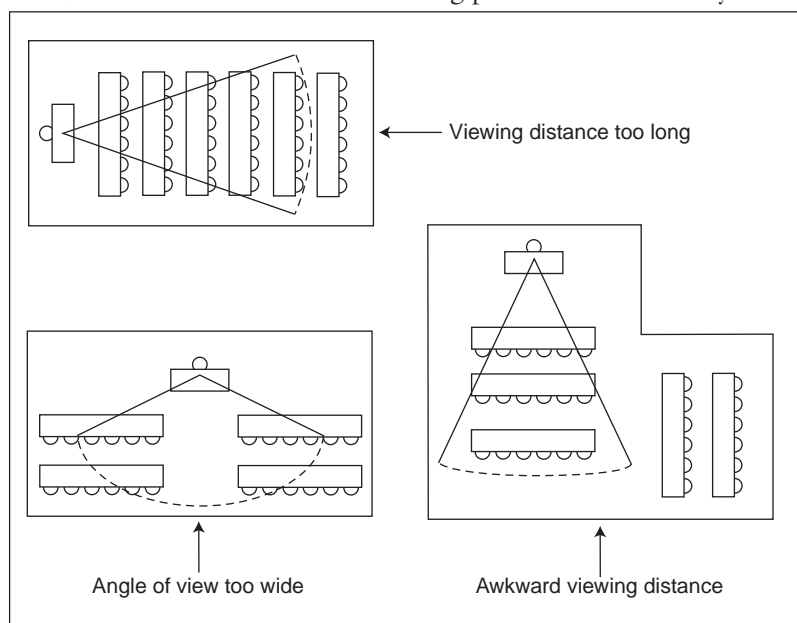
### A planning strategy

Schools may find it useful to establish a planning strategy for the laboratory. They may want to ensure that, regardless of the servicing system used, a suitable environment will be provided that is capable of responding in a flexible way to the activities taking place.

The serviced system layouts in this section are based on the zoning diagram illustrated in Figure 2/4 and the planning strategy outlined below. A group size of around 30 pupils is assumed (although the general principles apply to other group sizes too).

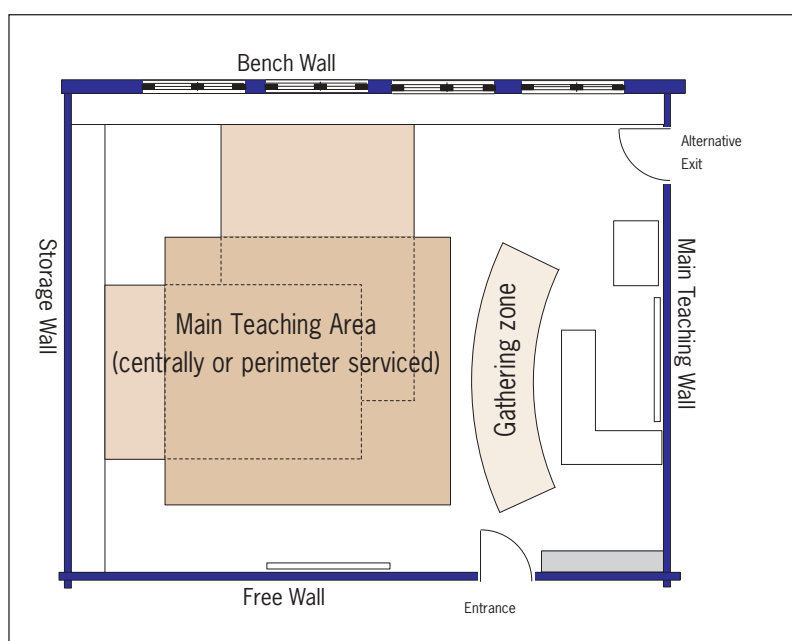
- A usable work surface area of at least 0.3m<sup>2</sup> per pupil is provided.
- An adjustable table for a wheelchair user and an additional seat for an assistant is provided. This is generally positioned with a direct view of the whiteboard and as near to the door as possible to avoid long routes.

**Figure 2/3**  
Viewing Distances



- All circulatory areas follow the planning guidelines outlined in Figure 2/5.
- Each pupil has good access to a full range of services, with a minimum of one gas tap, one socket outlet per pupil and one sink per 6 pupils.
- Each laboratory has one wash-up sink with hot and cold water.
- The **'main teaching wall'** provides a focus for whole class discussion, presentation and demonstration. There is a serviced unit with built in provision for computer network connection, a loose table of 2m (in some cases two), a fume cupboard and an interactive whiteboard.
- A clear area in front of the teacher's table is provided to allow pupils to gather together for briefing sessions and demonstration of experiments with sufficient space to use a fume cupboard when needed (see 'Fume Cupboards', Section 4).
- As the fume cupboard shown is assumed to be mobile, an alternative 'pulled out' position is shown.
- Whenever possible, pupils face the 'main teaching wall' in order to get a clear view of the teacher, the whiteboard and other presentation media.
- Where possible the teaching wall is placed at 90° to the external wall, to minimise glare or screen reflections from the window.
- In centrally based servicing systems one wall is designated a **'bench wall'** which is ideally the external wall. Here perimeter benching is used as additional shared work surface, with mobile tray and cupboard units underneath.
- Where possible one wall is designated a **'free wall'** without fixed furniture where trolleys for example can be parked. A second whiteboard is shown on the 'free wall' to allow an alternative position for teaching and learning activities.
- Where possible, one wall is designated a **'storage wall'** providing free standing storage as well as horizontal display and supplementary work surface. It is assumed that the storage units will be on braked castors to allow easy re-organisation. Wall mounted cupboards are not used as they may be a potential hazard if storage is not positioned underneath. The storage is additional to that on the 'bench wall'. The 'storage wall' may also provide an alternative space to the 'free wall' for trolleys to park when resources are being delivered or picked up by technicians. For this reason it is best placed next to the entrance.
- Storage of between 4m<sup>3</sup> and 6m<sup>3</sup>, concentrated above and below the perimeter benching, is provided for local resources and display. This assumes a separate preparation area of the size recommended in Section 3.
- Laptop computers are assumed, with a position for a laptop trolley shown on the 'free' or 'storage' wall. Where a bank of computers is required it could be positioned on the 'storage wall', usually at 90° to the window.
- A storage facility is included for pupils' coats and bags adjacent to the door and the teacher.
- A clear floor length of around 3m is allowed within the circulation route for runway experiments.

**Figure 2/4**  
Zoning diagram



### Planning for safety

The spaces shown in this section have been planned with health and safety in mind. Means of escape in case of fire is an important consideration in a practical activity such as science and Part B of the Building Regulations<sup>1</sup> must be adhered to. In these plans, a second door is shown leading to another space which provides an alternative means of escape in case of fire. In ground floor laboratories a door leading directly to the outside is desirable and there may be circumstances where a second door onto the corridor is needed. A second door becomes more important on floors other than the ground floor.

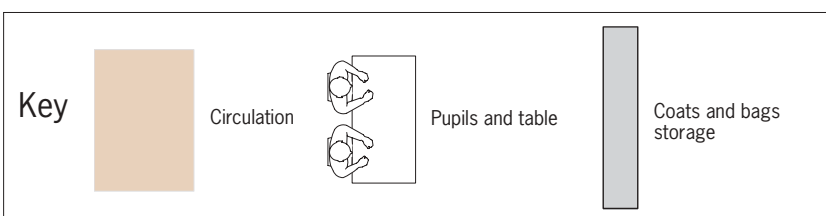
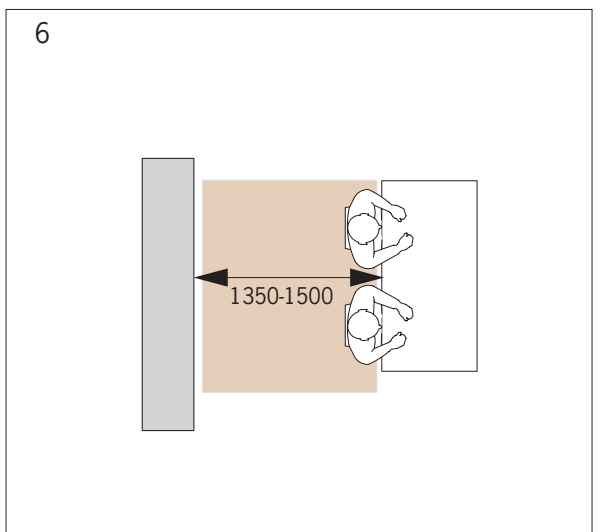
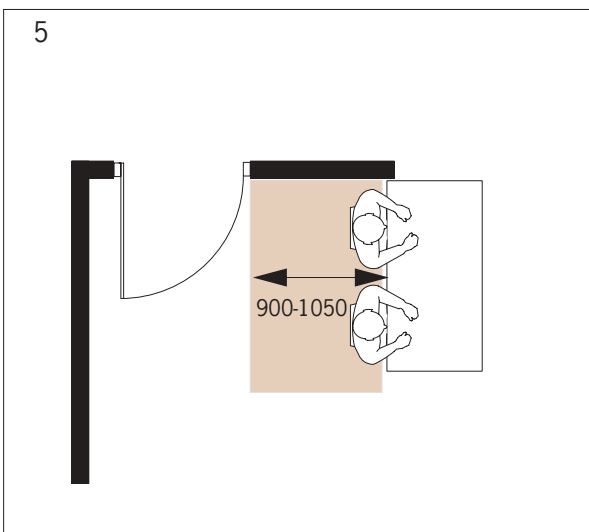
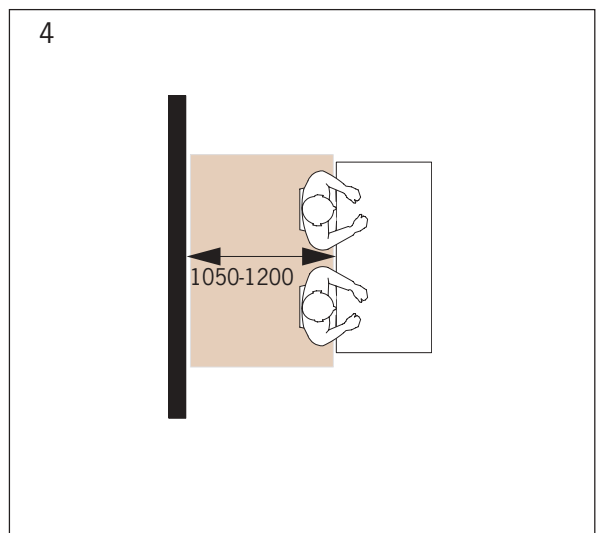
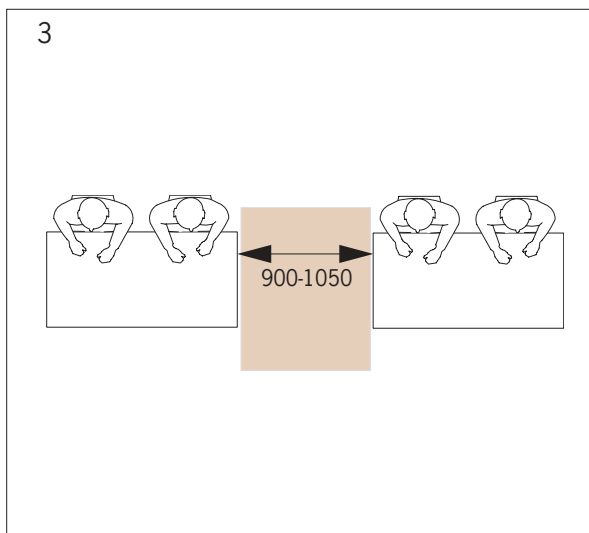
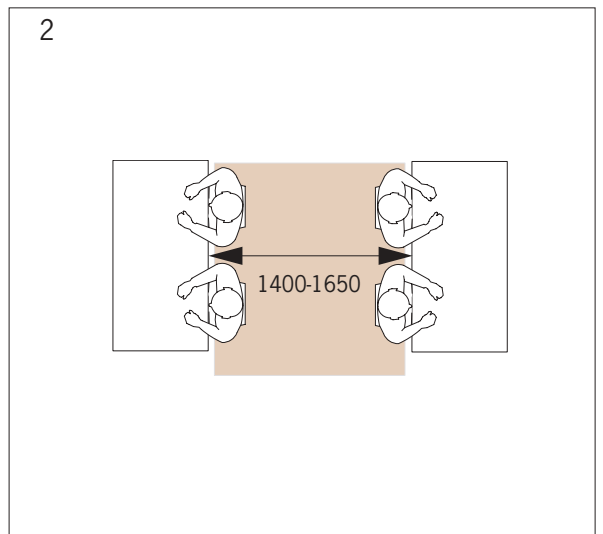
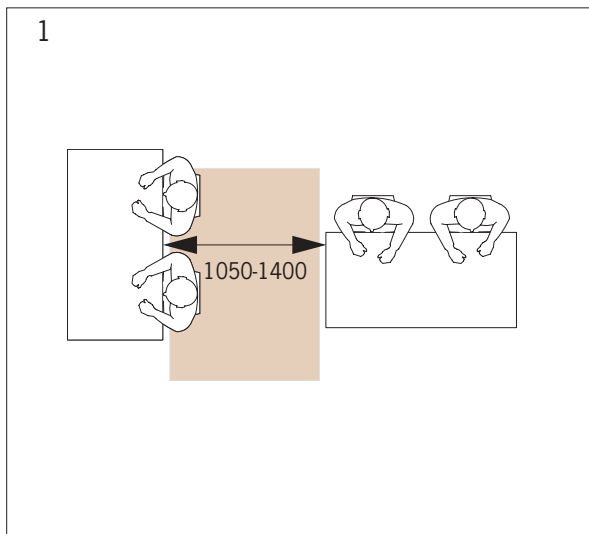
It is important to allow adequate distances between furniture and equipment in laboratories to allow pupils and staff (including those in wheelchairs) to move around safely, particularly during practical sessions. Figure 2/5 provides a guide to the distances required between furniture. The information is based on BS EN 14056: 2003 with additional dimensions given for space around doors etc. Space allocation should fall within the range illustrated and will depend on the amount of circulation required, and the type of layout and activities envisaged. Where possible, maximum circulation distances are used to enable access to all areas of the laboratory for wheelchair users.

#### Notes

<sup>1</sup> Approved Document B-Fire Safety, The Stationery Office 2000.

<sup>2</sup> Department for Education and Employment 'Fume Cupboards in Schools' (Revision of DN 29). BB 88, TSO 1998.

The fume cupboard is positioned away from the fire exit or main circulation routes with good access for groups of pupils during demonstrations. Safe distances around fume cupboards are given in Building Bulletin 88.<sup>2</sup>



**Figure 2/5**  
Safe Distances

**Services distribution**

Services distribution within a laboratory can have a significant effect on future building adaptations, maintenance and the choice of furniture that can be accommodated. There are three main options for the distribution of services within the laboratory.

- Underfloor (Figure 2/6).
- Perimeter (Figure 2/7).
- Overhead (Figure 2/8).

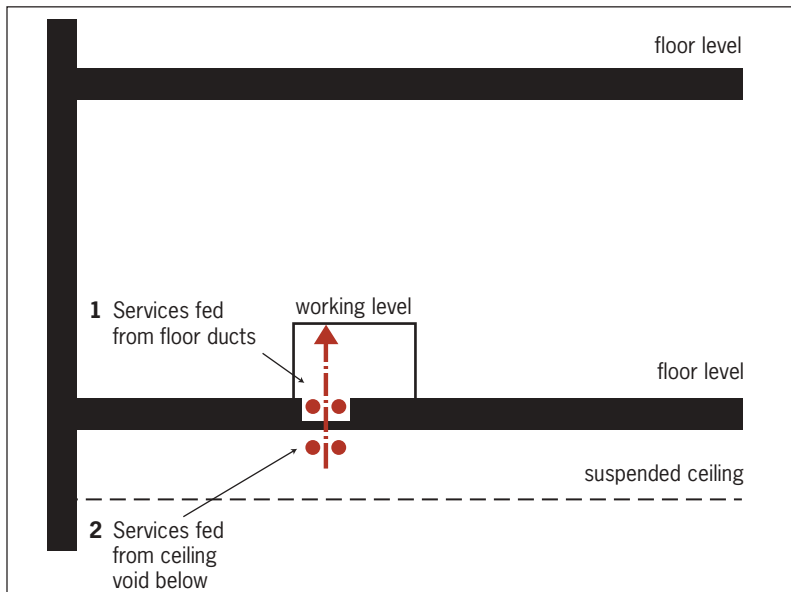
Within each option there are variations and sometimes two systems may be combined. The systems need to service three different ways of arranging the

serviced units and work surface layout arrangement (in some cases these may be combined):

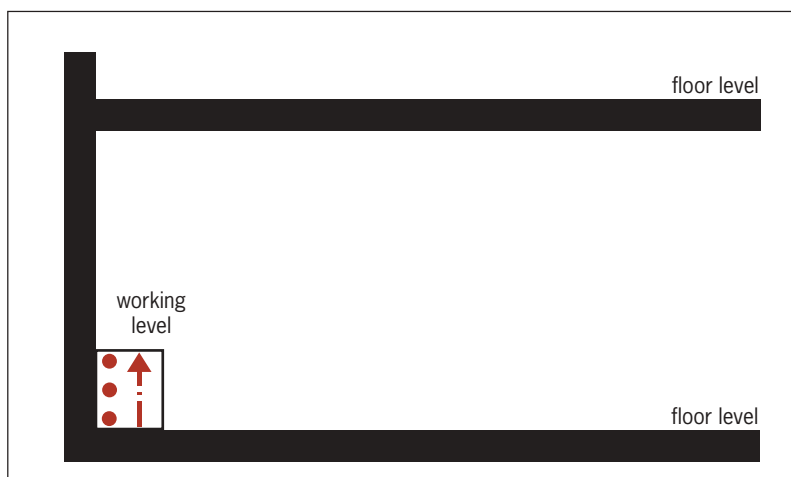
- peninsular, where the furniture projects from the walls into the room at 90°;
- island, where furniture stands in the centre of the room;
- perimeter, where furniture is positioned against a wall and does not project into the room.

Some systems may work with all three furniture arrangements, some will be more appropriate to just one.

**Figure 2/6**  
Underfloor Servicing



**Figure 2/7**  
Perimeter Servicing



**Underfloor**

In this option, services may either be run in ducts set into the floor with varying degrees of accessibility or located in the ceiling void of the room below. Services reach bench top level via rigid or flexible connections usually encased within furniture.

The advantages of this system include:

- Perimeter, peninsular and island benching layouts can be serviced.
- The laboratory looks neat with no exposed servicing cables or pipes.

The disadvantages of the system are:

- Water supplies and drainage need careful separation from electrical services in floor ducts.
- If services are distributed in the ceiling void of the room below, modifications and maintenance will disrupt this room.
- As serviced units have to be located over floor outlets, there is limited scope for re-positioning.
- In an existing building it may difficult to run services in ground floor rooms with concrete floors.

## Perimeter

Perimeter service ducts are usually located at bench level or below, with drainage at a low level.

The advantages of this system are:

- services may come into the room from one point and then be ‘threaded’ through the furniture;
- all services, including drainage, are accessible from the space they serve simplifying maintenance and future changes;
- services are less likely to be damaged since they can be concealed by benching. The appearance of the laboratory is also more tidy.

The disadvantages of the system are:

- benching often needs to be linked together which may restrict teacher access to pupils in the case of an accident;
- services may have to be routed around door openings etc;
- where services are fixed to internal partitions this can restrict future planning changes.

As a laboratory may be serviced from one perimeter supply point and services are kept separate from the building fabric, the system is particularly suitable for conversion or upgrading work.

## Overhead

In this option services run at high level in one of three ways: in trunking which is suspended below ceiling level, in a recessed ceiling duct or in the ceiling void with a network of outlets set into the finished surface. Services are distributed to the furniture below by means of flexible pipes or cables hung from a boom running along the length or width of the classroom. Overhead supplies are generally combined with a gravity drainage system incorporating a network of floor outlets serving island sink units. Alternatively sinks may be provided only

at the perimeter. Pumped or vacuum drainage systems which run in the overhead ducts are also a possibility although such systems can have significant maintenance implications.

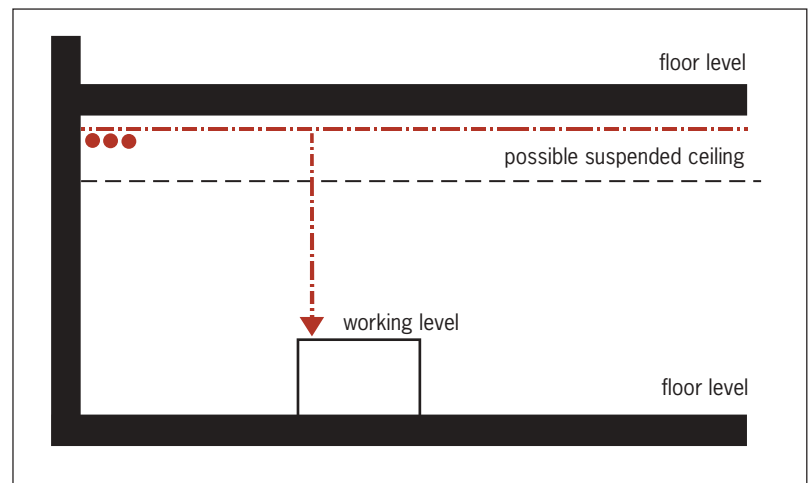
The advantages of this system are:

- perimeter, peninsular and island benching layouts can be serviced in a variety of configurations;
- there is flexibility in the location of furniture;
- services are readily accessible from within the laboratory which can simplify maintenance and allow adaptations to be carried out without disrupting other spaces.

The disadvantages of the system are:

- the servicing connections from ceiling to the working surface below can obstruct sight lines to the teacher’s position;
- the vertical service ‘droppers’ can look untidy and may be vulnerable to damage;
- currently available pump and vacuum drainage systems involve floor standing units which take up space and require regular and specialist maintenance, some drainage systems may also be noisy.

**Figure 2/8**  
Overhead Servicing



**Figure 2/9**  
Typical Serviced Spine

### Serviced Systems

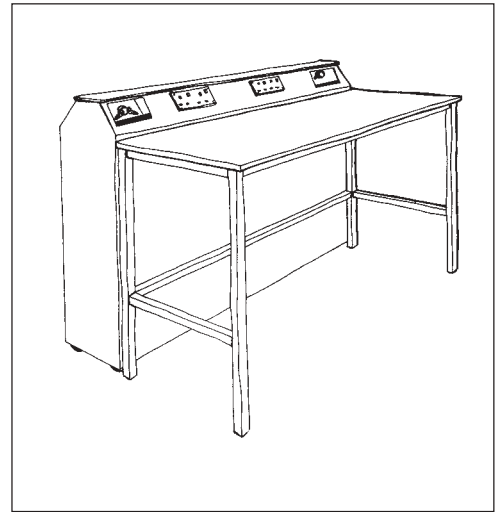
There are several systems which work with one or all of the servicing distribution methods outlined above. Systems which are flexible enough to allow a variety of layouts are highly desirable. For example, it may be advantageous to be able to move tables to create a clear floor area for certain activities. The choice of system will depend partly on the servicing method that is chosen, and on the level of available resources. Furniture systems can be divided broadly into the following four generic types.

- Serviced spines.
- Serviced bollards.
- Serviced pods.
- Serviced furniture.

Each system is described in the following examples and variations within each type are illustrated in detail. All the laboratories are the same size (90m<sup>2</sup>) showing the effect that different systems may have on an identical space. The effect of room shape is also demonstrated by showing each system laid out in two depths of space (8.5m and 9m). Black dots represent pupils with little or no direct view of the teacher, this takes account of difficult viewing angles (see Figure 2/3). Each layout has a data<sup>3</sup> box which summarises information on service and storage provision, the amount of access and the level of working area directly available to a pupil. It also looks at the amount of area (expressed as a percentage of the overall circulation) which can be accessed by wheelchair users or others with limited mobility. An accessibility study was also carried out which assessed the ease by which wheelchair users could access eight key areas of the laboratory and given a score of 1 to 4. These features included the wash up sink, fume cupboard, teachers table etc. Access to a second whiteboard was also assessed however in perimeter based layouts where a second whiteboard was not available a maximum score of up to 28 was given.

#### Note

<sup>3</sup> Individual work area includes serviced units. Sink provision does not include the wash-up sink.



### Examples of Serviced System Layouts

#### Serviced Spines

A serviced spine which can serve island, peninsula or perimeter table layouts is a freestanding serviced box incorporating a number of outlets. A spine can provide both dry and wet services and may be fed from overhead, under the floor or the perimeter. Spines may either be fixed or connected via a flexible cable to the floor. In flexible connections the under-frame of the spine is often clamped to the tables it serves. Most perimeter serviced spines must be clamped back to the wall.

The key characteristics of all the serviced spine examples shown here are:

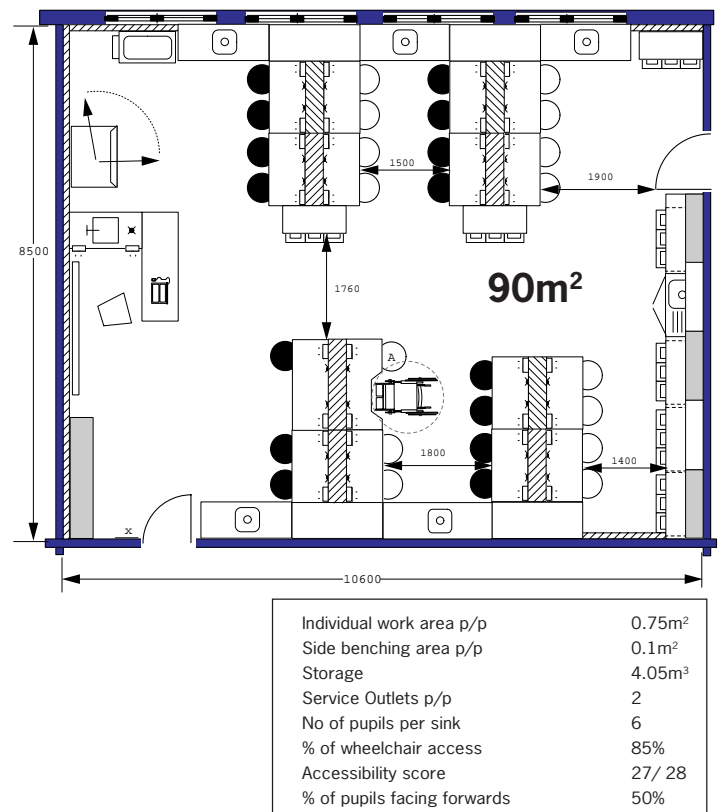
- a 1200 x 600mm table may be small for wheelchair users and their assistant. A table increased in 600mm increments allows it to be positioned alongside other tables used in the system;
- it is necessary with both versions to put the fixed benching on an internal wall which can be more expensive to fit as the drainage will have to be routed through to the external wall;
- as the system relies on perimeter services it is not possible to have either a 'free wall' or loose 'storage wall'. (See Planning Strategy above).

**Spine & Perimeter Sink (Figure 2/10)**

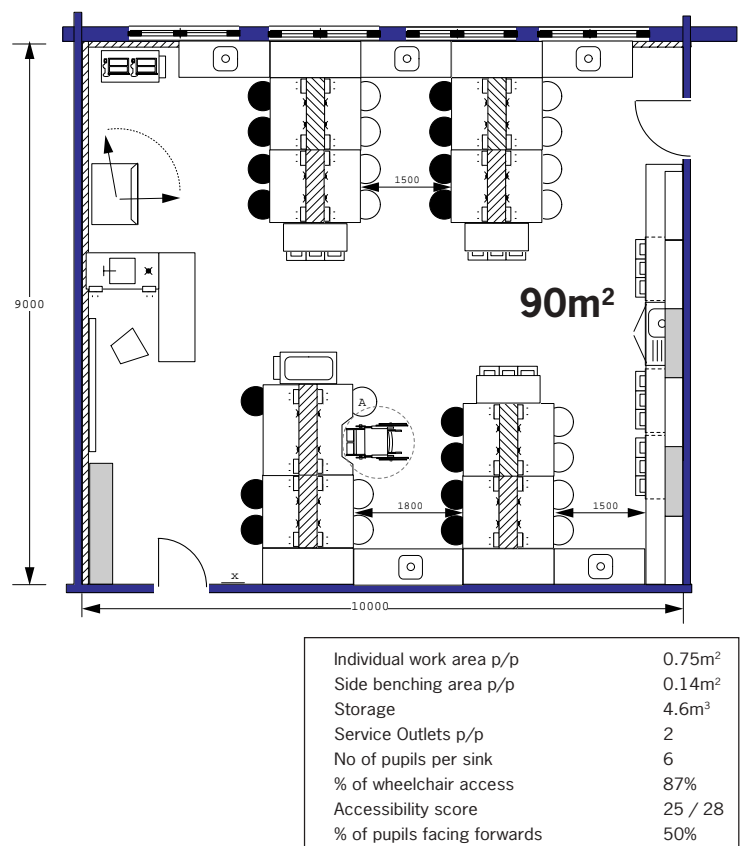
A 1200 x 300mm spine carrying gas and power serves a series of 1200 x 600mm and 1500 x 600mm tables clamped around it. Water is provided by 1500 x 600mm sink tables along the perimeter, although they could be fed from the floor or ceiling. To avoid disruption to pupils working alongside the perimeter the sinks are positioned in the centre of the table. The key features of the layouts shown here are that:

- because the 600mm deep perimeter table projects into the centre of the room there are fewer problems with wide angle views of the whiteboard than in Figure 2/11 below;
- the need for 600mm deep tables around the edge of the room results in less floor area for circulation which limits access to all areas of the lab for a wheelchair user;
- working in modules of 1500mm and 1800mm for the peninsula layouts restricts circulation and may prevent wheelchair users from accessing the perimeter sinks;
- for stability tables must be positioned along either side of the spine. This results in 16, rather than 15 tables, for 30 pupils;
- where there is a table opposite the wheelchair user it is recommended that it is used for one pupil only. This allows the disabled pupil an uninterrupted view of the teacher and whiteboard;
- perimeter sinks may present problems as spillages may occur when pupils are taking water to their table groupings;
- some of the perimeter work surface may be inaccessible and therefore wasteful of space.

Peninsular systems often work better in shallower rooms. In the 8.5m deep laboratory there is more space around the teachers unit and less underused space in the centre of the room than in the 9m deep version.

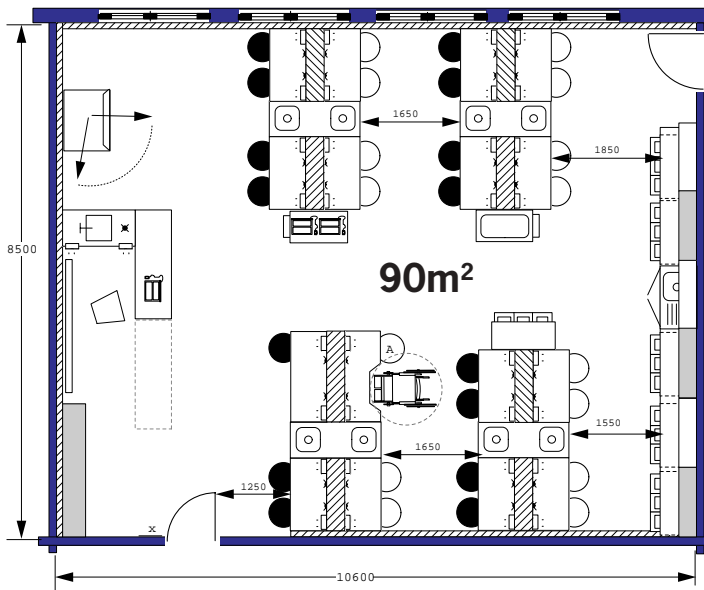


**Figure 2/10a:**  
Spine and Perimeter Sink (8.5m).



**Figure 2/10b:**  
Spine and Perimeter Sink (9m).

## Section 2: The Laboratory



Individual work area p/p	0.61m <sup>2</sup>
Side benching area p/p	0.13m <sup>2</sup>
Storage	4.05m <sup>3</sup>
Service Outlets p/p	2
N of pupils per sink	3.75
% of wheelchair access	92%
Accessibility score	25 / 28
% of pupils facing forwards	50%

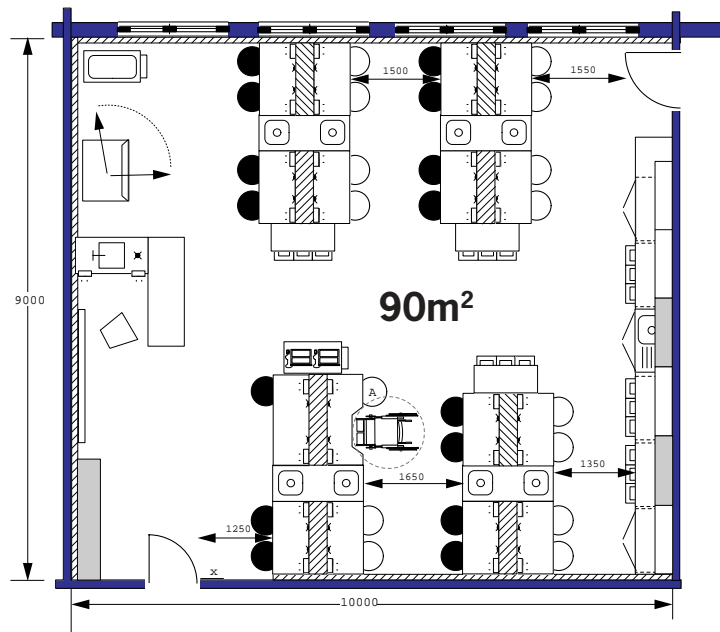
**Figure 2/11a:**  
Spine and Island Sink (8.5m).

### Spine & Island Sink (Figure 2/11)

A similar spine system to Figure 2/10 but in this case the spines, in addition to providing gas and power, carry water and drainage to and from 1500 x 600mm sink tables. The layout is more flexible because distances between the tables are not restricted to the size of perimeter based furniture. The key features of the layouts shown here are that:

- sinks are accessible to all pupils;
- peninsula runs can be positioned anywhere along the perimeter ducting;
- some pupils sitting alongside the perimeter of the room have a wide-angled view of the teaching wall although there is adequate gathering space around the teachers serviced unit.

Peninsular systems often work better in shallower rooms. In the 8.5m deep laboratory there is more space around the teachers unit and less underused space in the centre of the room than in the 9m deep version.



Individual work area p/p	0.61m <sup>2</sup>
Side benching area p/p	0.14m <sup>2</sup>
Storage	4.9m <sup>3</sup>
Service Outlets p/p	2
N of pupils per sink	3.75
% of wheelchair access	84%
Accessibility score	25 / 28
% of pupils facing forwards	50%

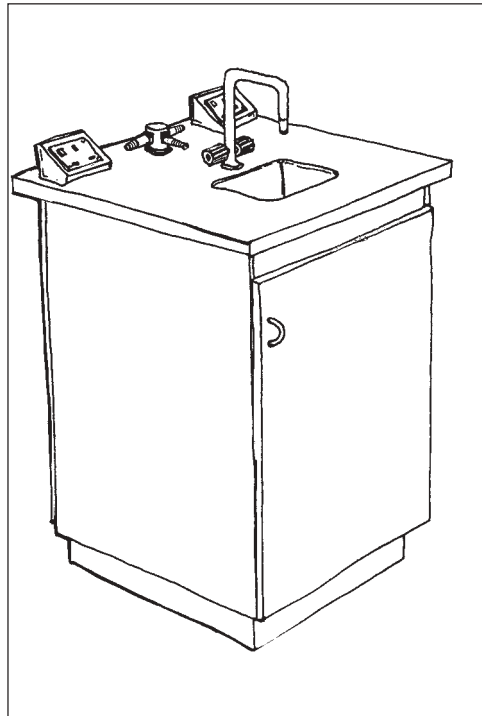
**Figure 2/11b:**  
Spine and Island Sink (9m).

### Serviced Bollards

Bollards (or pedestals) are usually fixed serviced units surrounded by loose (usually 1200 x 600mm) tables which can be arranged in various ways, although the choice of layout may be limited if space is restricted. Bollards are usually serviced from under the floor in which case the position of floor outlets determines the location of the bollards. However, some units may be linked to either perimeter or overhead servicing systems. Wet and dry services may be provided in separate serviced bollards but they are usually combined in one unit.

This section illustrates four variations on the bollard system. Key characteristics common to each are noted below.

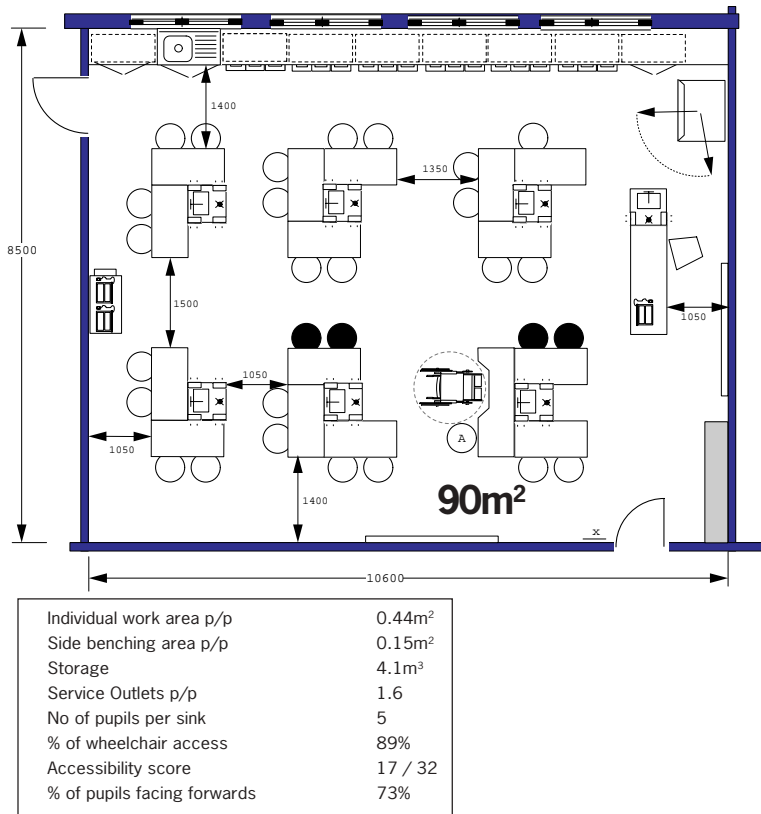
- Bigger tables in modular 600mm increments for wheelchair users can easily be incorporated into the system.
- All pupils have a good view of the teacher.
- As furniture is based in the centre of the room, only one wall of fixed furniture is necessary.
- Water is easily accessible alongside other services.
- The run of underfloor services limits bollard positions (including the teacher's position) but if positions are carefully considered at an early stage then a number of table arrangements are possible.
- Some bollards higher than 900mm have electric sockets on the side of the unit and therefore on a different surface from water. This does have the disadvantage, however, that items placed on the surface may fall off onto the table below which could be dangerous and pupils may fiddle with outlets hidden by the bollard.
- If the position of the bollard is carefully considered, tables can be rearranged in a variety of ways. However, the extent to which tables are re-arranged depends on a number of factors including the design of the table, the condition of the floor and the number of teachers using the same laboratory.



**Figure 2/12**

Typical Serviced Bollard  
900mm high.

## Section 2: The Laboratory



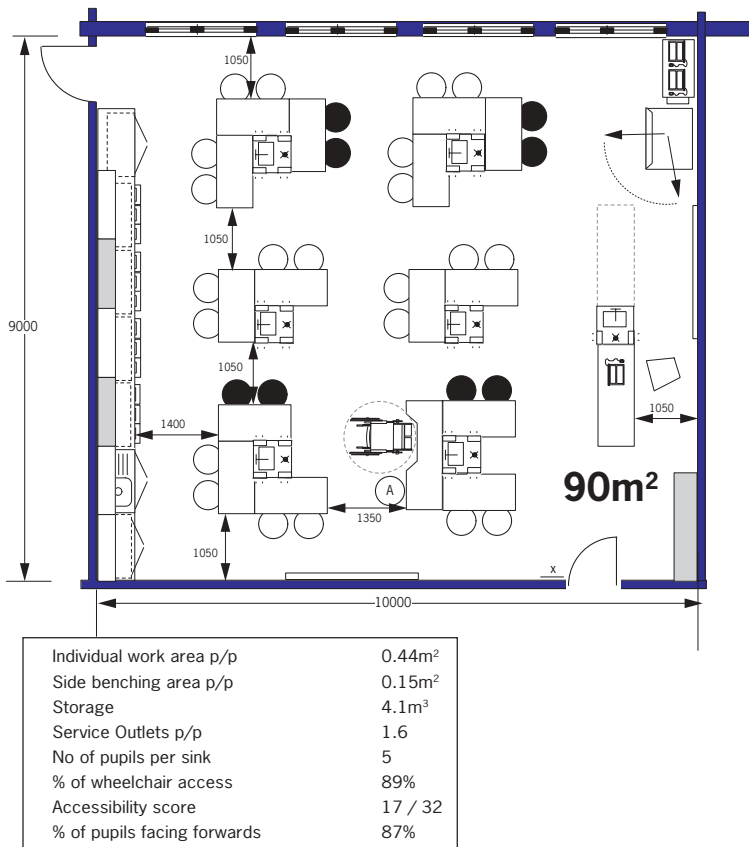
**Figure 2/13a:**  
6 Person Bollard (8.5m).

### 6 Person Bollard (Figure 2/13)

A series of six floor serviced 600 x 600mm bollards provide water, gas and electricity for up to six pupils each. The key features of the layouts shown here are:

- the gathering area around the teacher is not generous although tables can be temporarily moved for the duration of a demonstration, discussion etc;
- the number of serviced units results in less floor area for circulation, limiting wheelchair access to some areas of the lab;
- it is necessary to have the second whiteboard opposite the window and there is insufficient space to provide a 'storage wall'.

The 8.5m deep lab allows the fixed bench to be on the external wall which is more convenient for drainage. The 9m deep space allows more space around the teachers unit and the fume cupboard to be located away from the entrance.



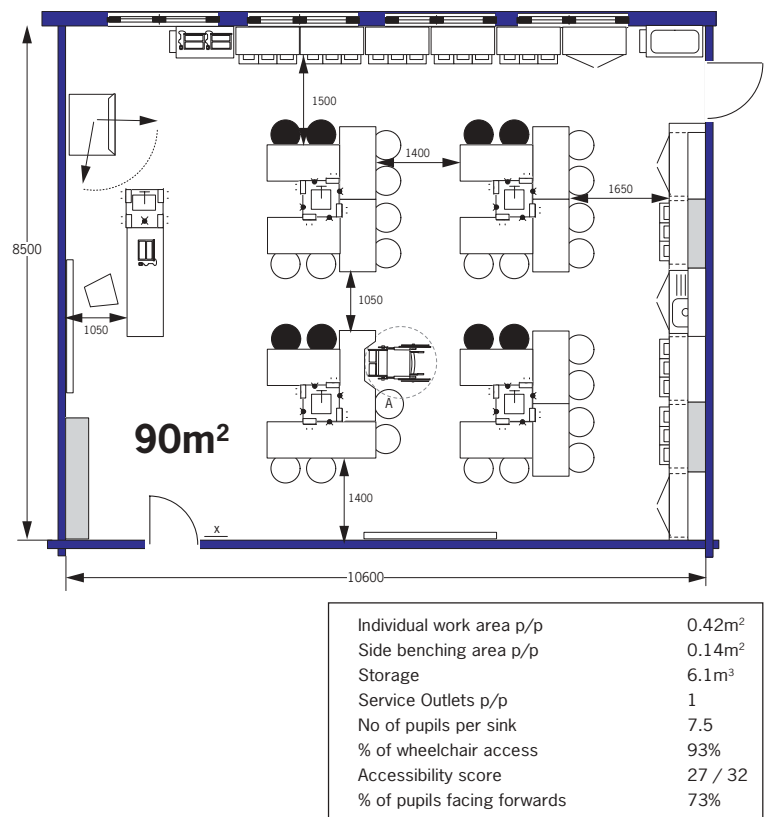
**Figure 2/13b:**  
6 Person Bollard (9m).

**8 Person Bollard Option A  
(Figure 2/14)**

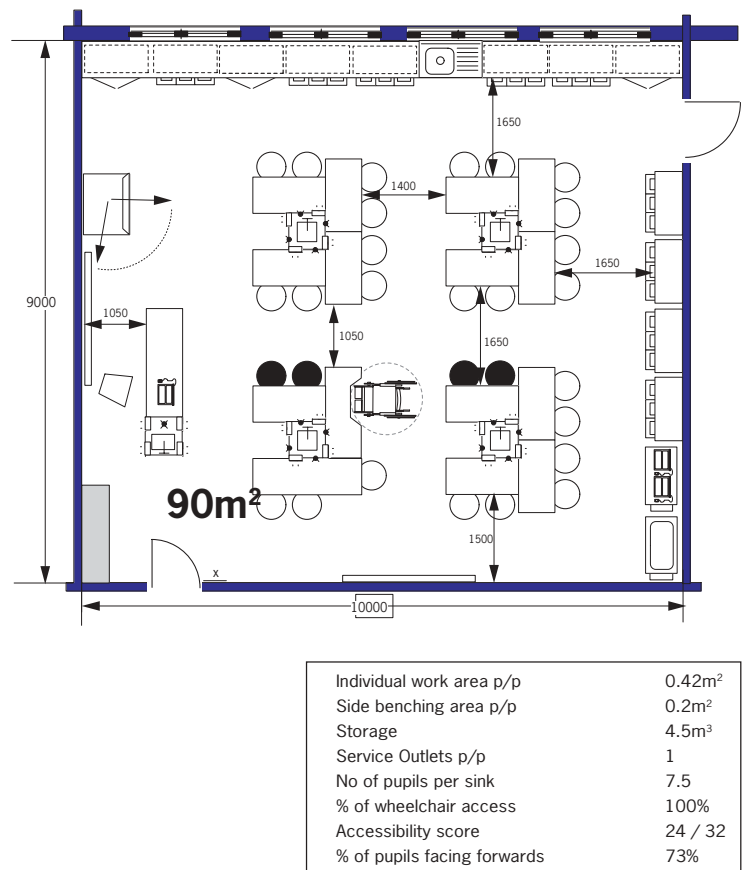
Four 600 x 600mm bollards provide services for up to eight pupils each. The key features of the layouts shown here are:

- the reduced number of bollards compared to the 6 person bollard layout above results in a simple layout with generous free floor area;
- in this table arrangement pupils have good access to services as well as being able to face the teaching wall for whole class activities;
- a ‘free wall’ is possible;
- an 1800mm table along side the wheelchair user’s table is long enough for three pupils.

The layout works more satisfactorily in the 8.5m deep room as there is more gathering space around the main teaching wall. The 9m deep space does not have as much circulation around the entrance although it does place the benching on the window wall which is easier and cheaper to service.



**Figure 2/14a:**  
8 Person Bollard (8.5m).

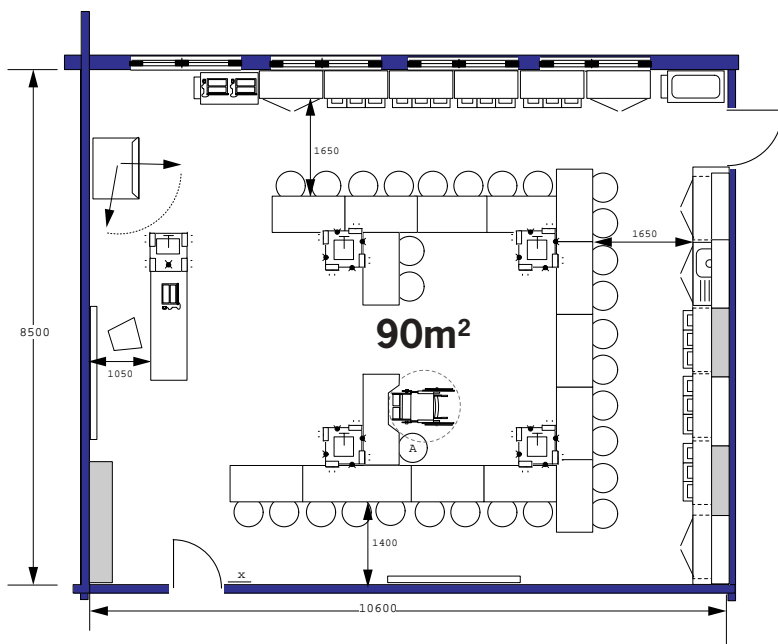


**Figure 2/14b:**  
8 Person Bollard (9m).

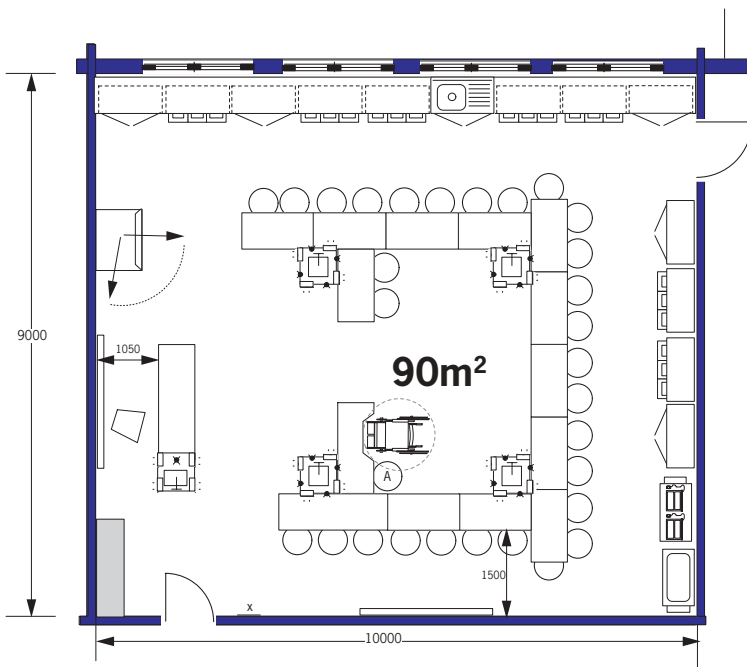
## Section 2: The Laboratory

### 8 Person Bollard Option B (Figure 2/15)

These plans show the same rooms with the tables rearranged into a horseshoe for class discussions. The 10.6m width works well for a plan layout of this shape. The 9m deep room works less well and it is therefore necessary for two pupils to sit at the end of a run of tables.



**Figure 2/15a:**  
8 person Bollard 'Horseshoe'  
Arrangement (8.5m).



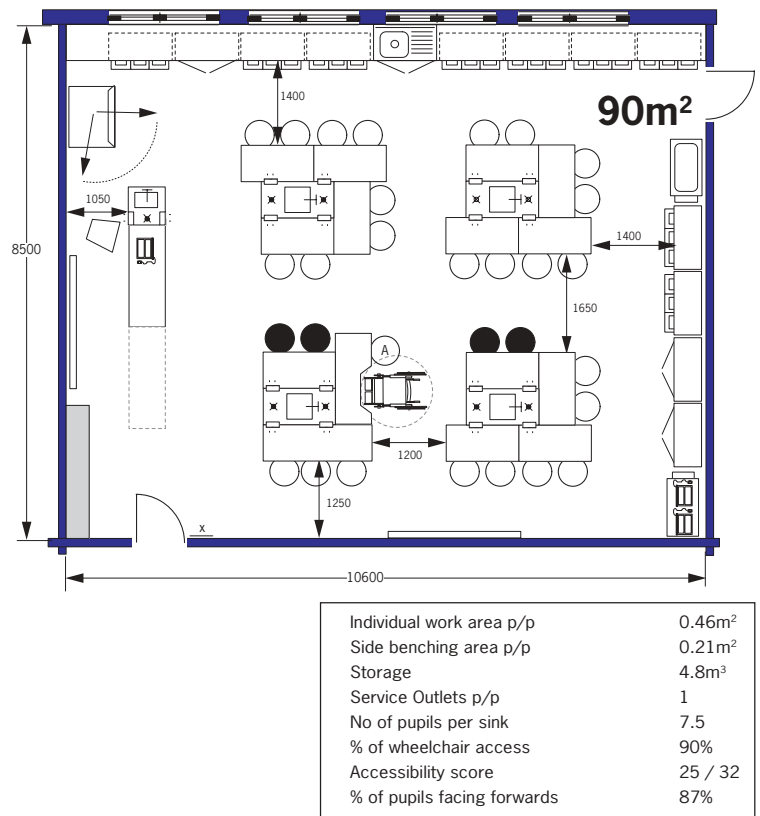
**Figure 2/15b:**  
8 person Bollard 'Horseshoe'  
Arrangement (9m).

**1200 x 600 Bollard  
(Figure 2/16)**

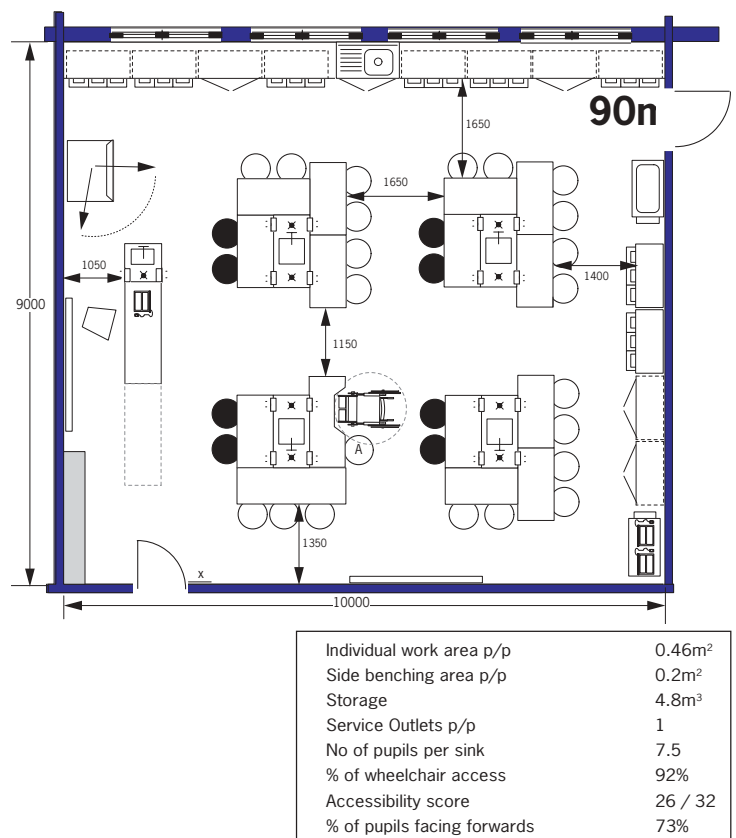
This plan shows four 1200 x 600mm bollards serviced from below, providing gas, water and electrical outlets for up to eight pupils. Although the bollards are larger than those in Figures 2/13 and 2/14, the servicing provision is assumed to be the same (although the sink is larger). The key features of the layouts shown here are:

- only one wall of fixed furniture is necessary and a free storage wall is possible;
- the increased size of the bollard makes demands on circulation space.

Both depths of space work effectively. In the squarer room it is necessary to orientate the bollards in a way which means that some pupils have their backs to the teacher. The 8.5m deep room works slightly better, allowing all pupils to face the front and allowing more space around the teachers unit for gathering.

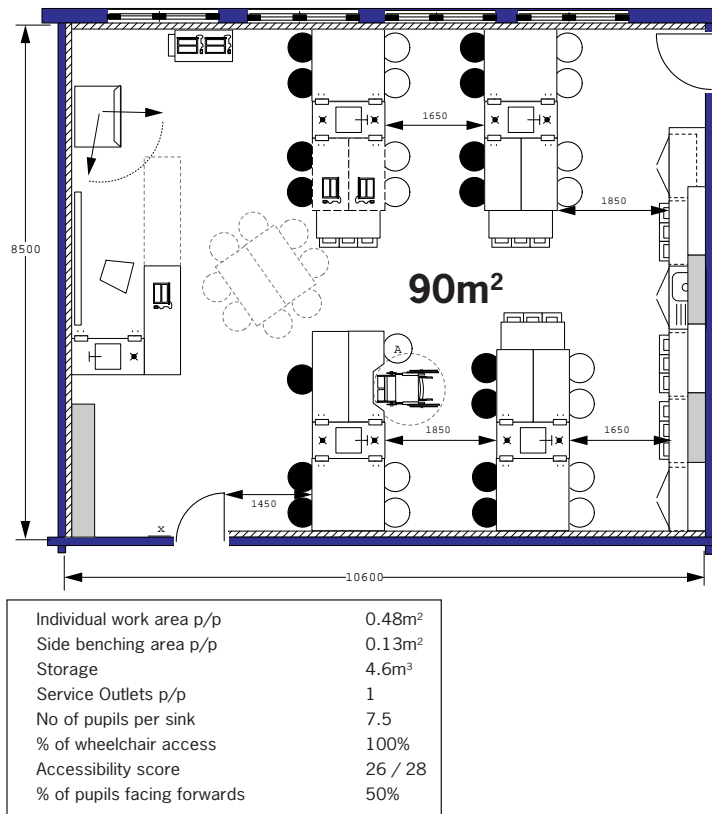


**Figure 2/16a:**  
1200 x 600 Bollard (8.5m).

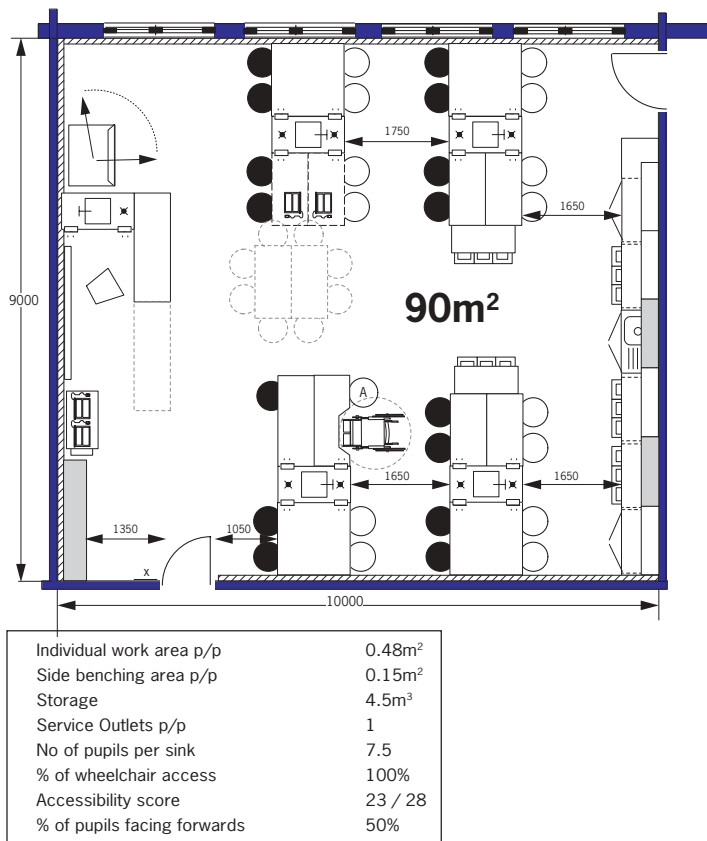


**Figure 2/16b:**  
1200 x 600 Bollard (9m).

## Section 2: The Laboratory



**Figure 2/17a:**  
Bollard and Perimeter Servicing (8.5m).



**Figure 2/17b:**  
Bollard and Perimeter Servicing (9m).

### Bollard and Perimeter Servicing (Figure 2/17)

Four 1200 x 600mm bollards provide a full range of services via perimeter ducting. A 1200 x 1200mm table which is clamped or fixed to the ducting carries services from the perimeter to the bollard. The tables on the other side of the bollard are loose. The key features of the layouts shown here are:

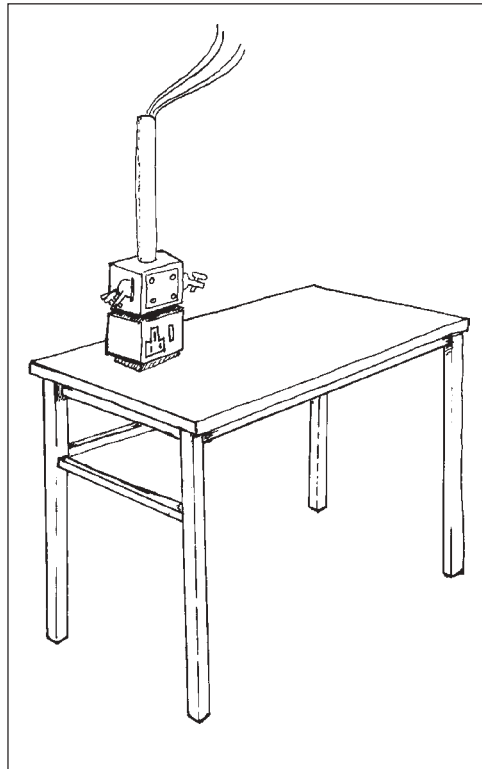
- some tables are moveable to allow some variety of layout;
- as the tables can be fed from anywhere along the perimeter duct there are fewer planning limitations than underfloor serviced bollards;
- the increased size of the bollard makes demands on circulation space;
- peninsula layouts create ‘corridors’ which are sometimes too tight for the wheelchair user to access;
- it is necessary with both layouts to put the sink integrated into fixed benching on an internal wall which can be more expensive to fit as drainage needs to run under the floor;
- as the system relies on perimeter services it is not possible to have either a ‘free wall’ or a ‘storage wall’. (See Planning Strategy above);
- pupils who sit on the tables which are directly against the wall seem remote from the teacher with viewing angles difficult. However there is good gathering space available around the teacher’s serviced unit.

Both rooms work equally well, although the 8.5m deep room has less wasted space in the centre.

### Serviced pods

Service pods are boxes containing outlets for electricity and gas which are clamped to table tops. They are fed from underfloor or overhead servicing. Flexible cables allow serviced tables to be moved within the limits of the connection length, giving a variety of layouts. In underfloor connections, where positions are set, it is worth looking at alternative layouts to determine the best position for the flexible connection.

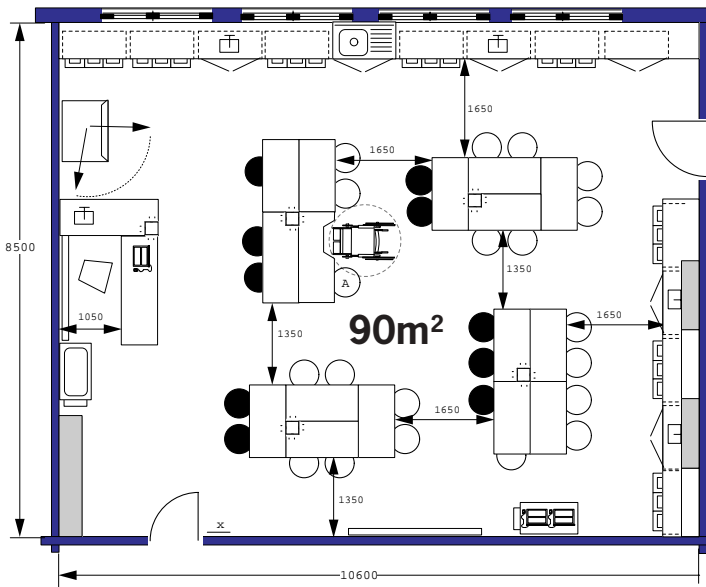
Pods can be fixed to perimeter, peninsula or island table layouts, although they are most effective in island arrangements. When the laboratory is served by an overhead boom, cables may be 'plugged in' at various points along its length. Separate pods with taps can provide water to sinks or drainage troughs which are usually connected to the perimeter, although in practice these are rarely used. A variation of this system is where sink tables are positioned alongside pods and tables in the centre of the room. Water and pumped drainage are connected to overhead service booms which can present maintenance and noise problems (see 'Overhead Servicing Systems').



**Figure 2/18**

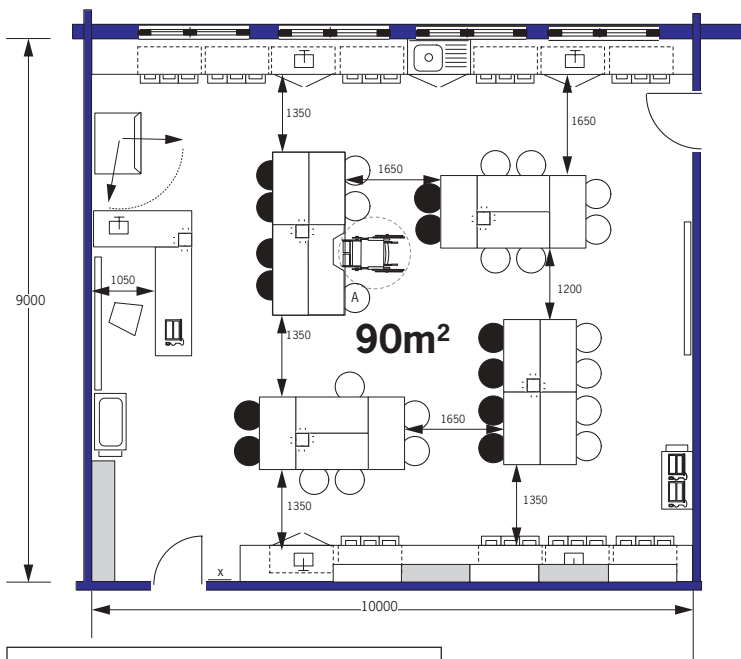
Typical Services Pod (serviced from above)

## Section 2: The Laboratory



Individual work area p/p	0.39m <sup>2</sup>
Side benching area p/p	0.21m <sup>2</sup>
Storage	6.3m <sup>3</sup>
Service Outlets p/p	1
N of pupils per sink	7.5
% of wheelchair access	100%
Accessibility score	27 / 32
% of pupils facing forwards	57%

**Figure 2/19a:**  
Pod and Perimeter Sinks (8.5m).



Individual work area p/p	0.39m <sup>2</sup>
Side benching area p/p	0.2m <sup>2</sup>
Storage	6.6m <sup>3</sup>
Service Outlets p/p	1
N of pupils per sink	7.5
% of wheelchair access	92%
Accessibility score	25/32
% of pupils facing forwards	60%

**Figure 2/19b:**  
Pod and Perimeter Sinks (9m).

### Pod and Perimeter Sinks (Figure 2/19)

This arrangement works with either overhead or underfloor services. In this version, pods only provide gas and electricity (for up to 8 pupils); the sinks are placed at the perimeter. The key features of the layouts shown here are:

- although two walls are used for perimeter benching one wall remains free for an additional whiteboard position;
- there are good distances between tables because the pod does not take up any floor space;
- three out of four tables are free of services and can be moved anywhere;
- a bigger table in modular 600mm increments for wheelchair users may be easily incorporated into the system;
- continuous perimeter servicing enables sinks to be positioned anywhere along the wall;
- placing sinks at the perimeter increases the total length of side benching required;
- positioning sinks away from other services can be a disadvantage if immediate connection to a sink is needed for an experiment. Perimeter sinks can present problems because pupils will have their backs to the teacher whilst accessing water and because spillages may occur when pupils are taking water to their table groupings;
- the tables to which pods are connected have a slightly reduced working area but this can be compensated for by perimeter tables;
- not all pupils face the teacher, but there is sufficient space to gather around for demonstrations etc.

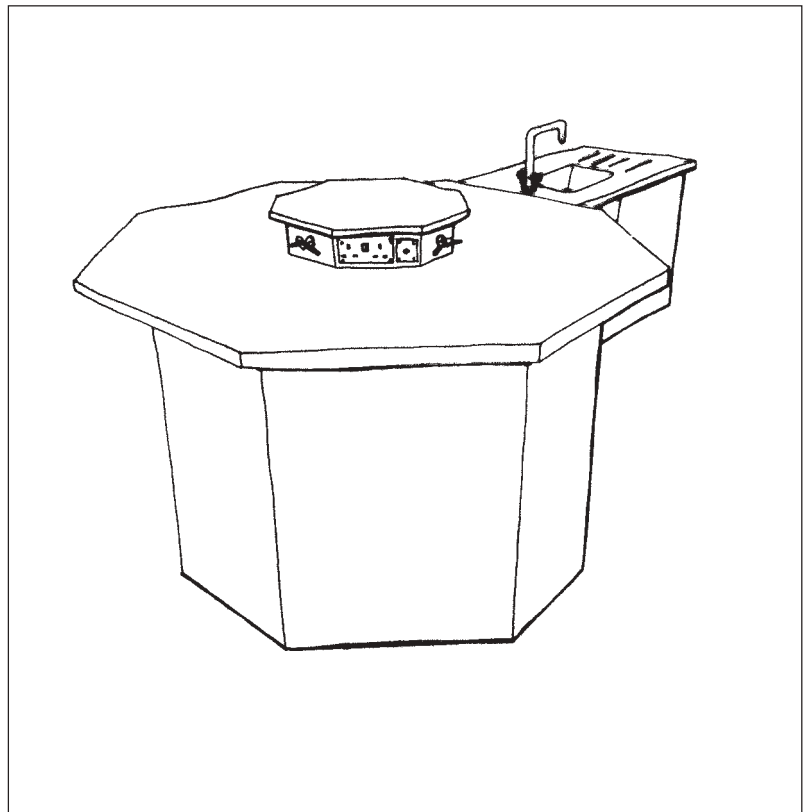
The 8.5m deep space offers most circulation, although the 9m deep space has more gathering area around the second whiteboard. The two runs of side benching are better positioned in the squarer shaped space with each grouping having ready access to a sink position, in the 8.5m deep shape one group is particularly remote from their sink.

## Serviced Furniture

In this type of system, services run within the furniture making them easy to access for repair and maintenance. Furniture can be linked together allowing services to supply a group of work places.

Installations are connected to the main services at one or more points, usually at the perimeter of the room. Interruptions in the wall may restrict the length of servicing and therefore several points may be necessary. Some systems may require tables to be fixed to the floor for stability thus limiting adaptability, although some can be connected to each other.

Two kinds of serviced furniture system are shown below. One based on the octagonal table unit and one based on a series of components that can be combined in a variety of ways.



### Serviced Octagon (Figure 2/20)

The two systems shown on pages 30 and 31 are based on fixed octagonal units, 1800mm in width, linked to a 1000 x 600mm sink unit.

Octagons can be serviced from underfloor or perimeter servicing, both options are shown here. Key characteristics common to this system are:

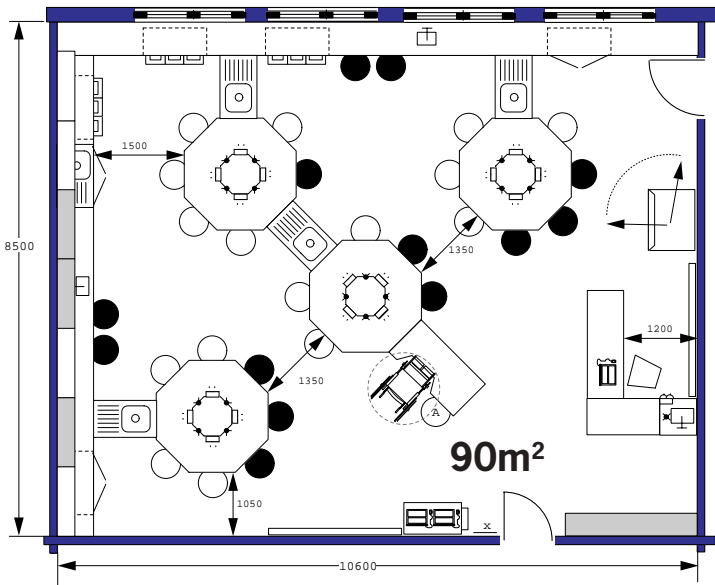
- a sink unit can be linked to an octagon at 90° or 45°;
- rather like serviced bollards, octagons are fixed to the floor which may limit flexibility;
- some octagons have a raised central turret which whilst it provides an additional work surface for books, task lights or computer screens, can sometimes affect visual supervision of pupils sitting at the units and reduce interaction necessary for group activities. It also encourages the storage of objects which may fall off onto the work surface below;

- the laboratory has a tidy appearance because the units are fixed;
- planning with such large units is restrictive and often results in minimum circulation distances which limits access by the wheelchair user;
- a separate adjustable table for a wheelchair user is necessary as it is very difficult to create a separate section of an octagon to rise and fall;
- this additional table results in the position next to the wheelchair user not being useable (due to the 45° angle of the unit, see plans below);
- the teacher's access to certain units may be restricted by the linking sink units, particularly in the perimeter serviced option. This is a particular issue in an emergency.

**Figure 2/20**

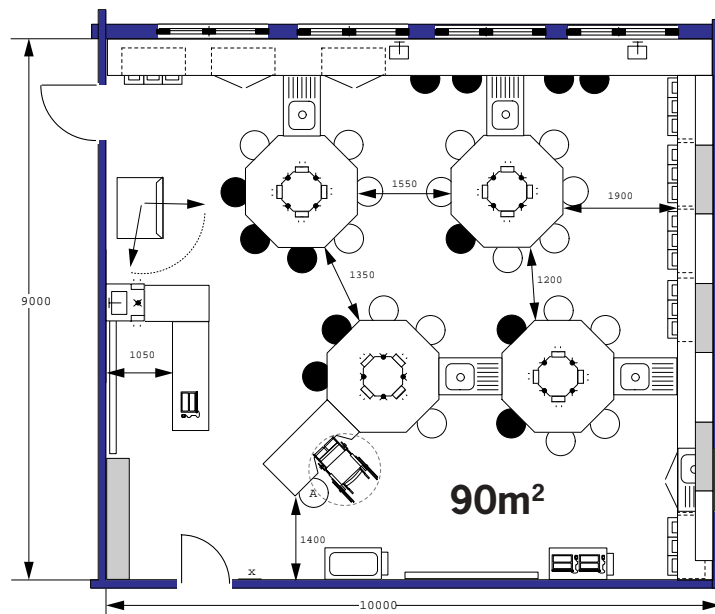
Typical Serviced Furniture System

## Section 2: The Laboratory



Individual work area p/p	0.51m <sup>2</sup>
Side benching area p/p	0.31m <sup>2</sup>
Storage	3.95m <sup>3</sup>
Service Outlets p/p	1.1
N of pupils per sink	5
% of wheelchair access	52%
Accessibility score	22 / 32
% of pupils facing forwards	57%

**Figure 2/21a:**  
Perimeter Serviced Octagon (8.5m).



Individual work area p/p	0.55m <sup>2</sup>
Side benching area p/p	0.28m <sup>2</sup>
Storage	5.15m <sup>3</sup>
Service Outlets p/p	1.2
No of pupils per sink	6
% of wheelchair access	73%
Accessibility score	20 / 32
% of pupils facing forwards	57%

**Figure 2/21b:**  
Perimeter Serviced Octagon (9m).

### Perimeter Serviced Octagon

The octagonal units are linked to perimeter services by the sink unit. Each octagon is designed for up to eight pupils, although this may reduce to six adjacent to link units. The key features of the layouts shown here are:

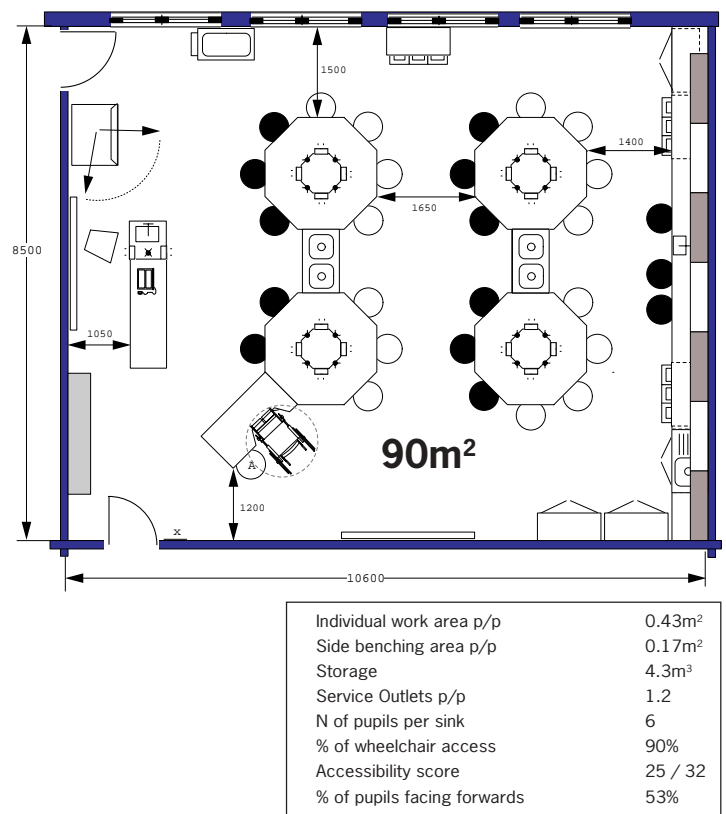
- despite using the perimeter for the main run of services this system only uses two walls, allowing a ‘free wall’ for a second whiteboard position;
- links at both 90° and 45° increase planning options but can create ‘triangles’ of space. However, these can be used very effectively as gathering areas, for example around the second whiteboard position;
- the layouts shown seat a total of 26 pupils, for additional pupils a length of serviced perimeter benching is required which makes viewing angles difficult.

The 8.5m deep space has a better teaching focus and a more generous area for the fume cupboard and class gatherings. The squarer shaped room has better circulation routes and fewer unusable ‘triangles’ of floor space. Neither layout allows the wheelchair user to be positioned directly in front of the whiteboard which may be problematic for some pupils.

**Island Octagon (Figure 2/22)**

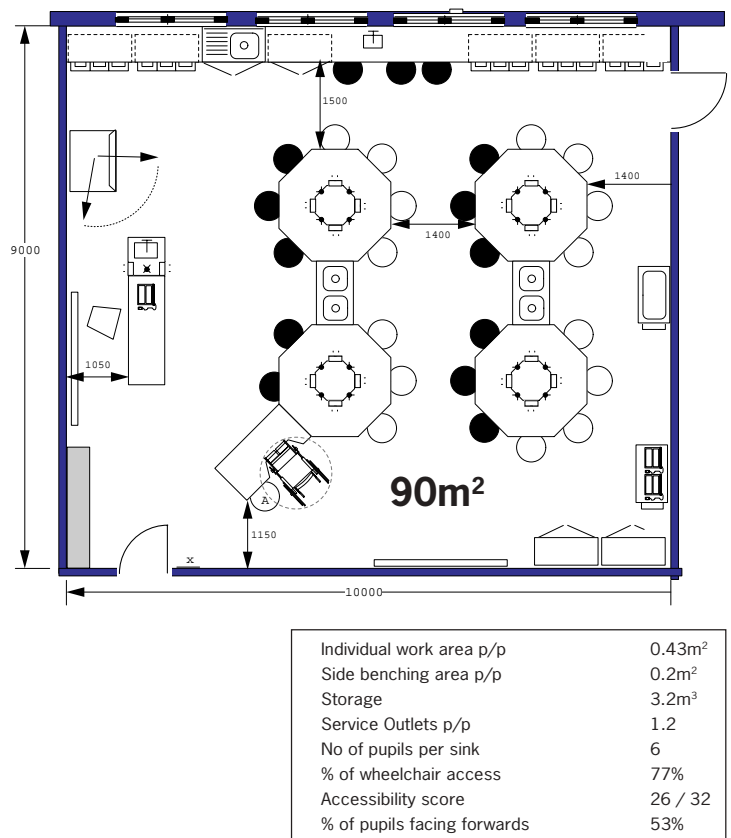
Here octagonal units are serviced from below and are isolated from the perimeter of the room. Two pairs of octagons with a shared double sink sit centrally in the laboratory. The key features of the layouts shown here are:

- the sinks are located directly adjacent to the each group;
- fewer links mean the units are more accessible to the teacher;
- fewer links mean more pupils can sit around the units;
- island units free up the walls for sidebenching etc;
- the layouts shown seat a total of 27 pupils, for additional pupils a length of serviced perimeter benching is required which makes viewing angles difficult;
- it is not possible for the teachers unit to follow the servicing run for the octagons and would therefore require another run of servicing through the floor.



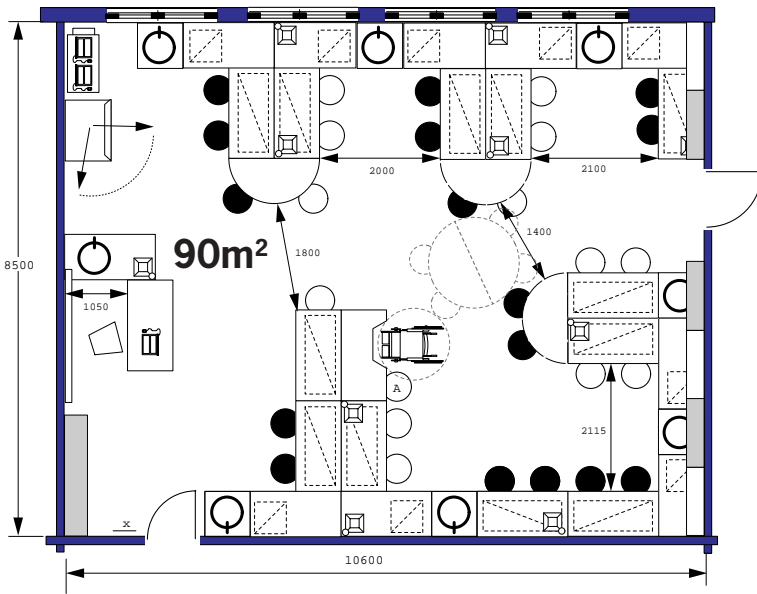
**Figure 2/22a:**  
Island Octagon (8.5m).

The position of the wheelchair user in both spaces determines the layout. Minimum dimensions for circulation have to be used, which may be a problem for wheelchair access. The 8.5m deep space offers more space between the octagon runs whereas the 9m deep space gives more space around the side benching. The 8.5m deep space offers more wall storage. Neither layout allows the wheelchair user to be positioned directly in front of the whiteboard which may be problematic for some pupils.



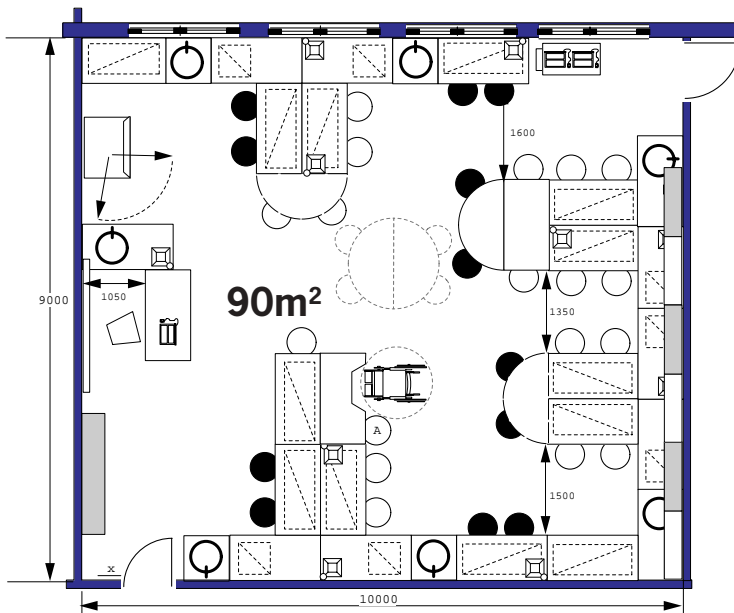
**Figure 2/22b:**  
Island Octagon (9m).

## Section 2: The Laboratory



Individual work area p/p	1.01m <sup>2</sup>
Side benching area p/p	N/A
Storage	8.15m <sup>3</sup>
Service Outlets p/p	2.1
N of pupils per sink	6
% of wheelchair access	100%
Accessibility score	20 / 28
% of pupils facing forwards	47%

**Figure 2/23a:**  
Perimeter Serviced Tables (8.5m).



Individual work area p/p	1.03m <sup>2</sup>
Side benching area p/p	N/A
Storage	8.46m <sup>3</sup>
Service Outlets p/p	2.5
N of pupils per sink	6
% of wheelchair access	91%
Accessibility score	22 / 28
% of pupils facing forwards	60%

**Figure 2/23b:**  
Perimeter Serviced Tables (9m).

### Perimeter Serviced Tables (Figure 2/23)

This serviced furniture system uses various components: a 1500 x 750mm table, a 750 x 750mm sink table and a loose un-serviced semi-circular table. The rectilinear tables carry services in trays clipped to their under-frames. Pyramid-shaped service pods at the corners of the tables provide gas and electrical outlets. The key features of these layouts are:

- the space can be re-arranged relatively easily, although a registered gas installer would have to be employed;
- loose tables can create note-taking areas in the centre of the space, particularly useful in square shaped rooms where, in other perimeter based layouts, the central area is often under-utilised;
- semi-circular tables ease the circulation routes;
- the tables to which pods are connected have a slightly reduced working area but the tables are slightly bigger than most other systems;
- an adjustable table can be easily incorporated for a wheelchair user;
- planning in 750mm modules can sometimes be restrictive although non-standard tables can be ordered to maximise space;
- ‘pockets’ of space are created in ‘U’ shaped layouts, although these may be useful for group gatherings;
- as all walls are utilised for serviced furniture there is no wall available for a second whiteboard, trolley parks or separate runs of side benching;
- perimeter sinks can present supervision problems as pupils will have their backs to the teacher when getting water and spillages may occur when pupils are taking water to their table groupings;
- one sink is used primarily as a wash-up sink and is therefore not counted as part of the overall sink provision.

The two layouts show similar results. The 8.5m deep is slightly more effective as less space in the central area is wasted, it offers more area around the demonstration table and wheelchair access is better as there are no narrow work ‘corridors’. However, in the 9m deep arrangement more pupils can see the teacher because more tables project from the wall opposite the teaching wall.

# Section 3: Support Spaces

This section looks at spaces which support the main timetabled teaching spaces. The number and type of support facilities varies greatly between schools; the examples shown here are not the only solutions.

## The Preparation Room

Providing a central preparation room that serves a group of laboratories makes efficient use of both floor area and staff time. This section outlines the basic requirement for one central preparation room (or two in a two storey department). The furniture layouts of two typical preparation rooms are illustrated in detail.

The preparation room in a middle school will be simpler than the room(s) described in this section. It will probably serve only one or two laboratories, but it may also be used to prepare trolleys of equipment for teaching pupils in years five and six in their classroom bases.

## Zones of Activity

A central preparation room can act as the main store room for a suite of laboratories as well as a workroom for the technicians. Five main zones of activity can be identified:

- main storage;
- preparation;
- dispensing and cleaning;
- trolley park;
- the clean working area and chemical storage.

These five zones and the relationship between them are illustrated in Figure 3/1. This diagram forms the basis of the

preparation room layouts in this section. Each zone is described in detail below.

## The Main Storage Area

Items of equipment used frequently by all pupils (such as tripods, Bunsen burners and goggles) are usually kept in the laboratory. All other equipment is best kept in a central preparation room where it can be checked regularly by a technician. The main storage area is best concentrated in one place, preferably located alongside the preparation and cleaning area.

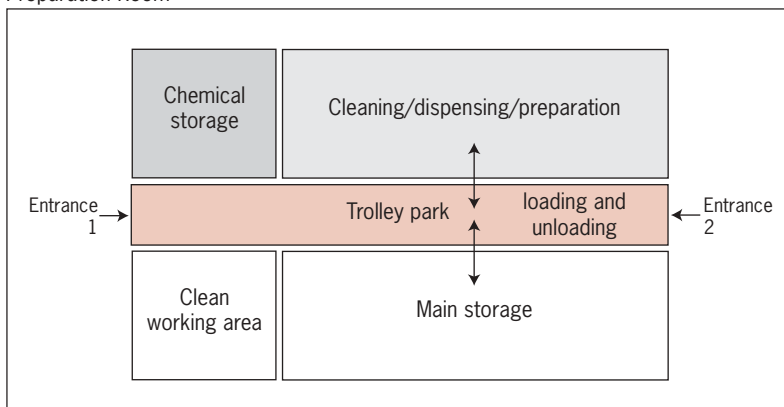
Storage is often in the form of free-standing timber or metal racks providing flexible storage systems which can be re-arranged to suit the available space.

An alternative method of bulk storage is the rolling unit system sometimes seen in library stockrooms. This system is very economical in its use of space because circulation is reduced, often providing approximately 30% more volume than a conventional system. However, it is expensive. The system is probably most appropriate for a large school with at least seven laboratories where it can be used for longer term storage while more frequently used materials can be kept on shelving or racking. Further details of storage systems can be found in Section 4.

## The Preparation, Dispensing and Cleaning area

This is the main working area for technicians. It is where glassware is washed, equipment is sorted after being returned on trolleys from lessons, practical experiments are prepared and small items of equipment are repaired. There needs to be enough free bench space for technicians to carry out these activities. This is in addition to any space that is taken up with small bench mounted apparatus such as an autoclave or distillation unit. Gas taps and electrical outlets should be provided and at least one sink in addition to the wash-up sink (which should have double bowl and drainer). Floor mounted equipment may include a fridge-freezer and dishwasher.

**Figure 3/1**  
Zoning of Activities in the Preparation Room



In order to dispense chemicals it may be convenient to position a serviced run of benching and the fume cupboard as near as possible to the chemical store. A fixed fume cupboard may be preferable to a mobile one because of the frequency of use by technicians. In a middle school, however, a mobile fume cupboard may be advantageous as it can be used for teaching as well as preparation. A ducted rather than re-circulatory type may be more appropriate for a middle school (see 'Fume Cupboards', Section 4). Fume cupboards should always be positioned away from circulation routes.<sup>1</sup>

### The Trolley Park

To facilitate loading and unloading the trolley park should ideally be located between the main storage zone and the preparation/cleaning area. The space needs to be wide enough to park the maximum number of trolleys (e.g. up to two per laboratory) and to allow circulation alongside. Additional parking space for trolleys may be needed at the entrance to the preparation room or adjacent to a hoist. Gas cylinders will need to be clamped safely to a wall or bench within the preparation room.

### The Clean Work Area

A discrete technicians' work area allows administrative tasks to be completed and may be positioned next to the main doors of the preparation room forming a 'reception' area. Furniture and equipment in this area may include a computer with internet connection, filing cabinets, lockers for technicians' belongings, a local task light and a telephone. TV programmes may be recorded in this area.

### The Chemical Store

Employers should follow recommended procedures based on risk assessments when using and storing chemicals. Reference should be made to COSHH (Control of Substances Hazardous to Health) regulations,<sup>2</sup> the Management of Health and Safety at Work regulations<sup>3</sup> and the DSEAR (Dangerous Substances and Explosive Atmospheres regulations).<sup>4</sup>

If bulk chemicals are kept by the school these should be kept in a separate store in the school grounds. In practice however, such stores are often underused and can be subject to vandalism. It is better to store smaller quantities in a separate locked chemical store, accessible only to technicians and teachers, ideally opening onto the preparation room. The total volume of highly flammable liquids should not exceed 50 litres in any one work room.<sup>5</sup>

The chemical store must be protected from frost and well ventilated to the outside air either by natural means or by appropriate mechanical extraction; full air conditioning is not necessary. The door should open outwards and contain a vision panel for means of escape reasons and it should be openable from the inside without a key in case of emergency. The floor should slope to a collection area away from the door. Alternatively, a slightly raised threshold will prevent chemical spills flowing underneath the door. The flooring material should be impervious to chemicals e.g. quarry tiles.

There are recommended ways of arranging chemicals on shelves in a chemical store, according to type.<sup>6</sup> It is an advantage if all shelves are shallow to avoid hidden bottles and shelving above head height is best avoided. Shelves should be made of a material which does not corrode (such as wood) in case of leaks and corrosive liquids should be kept on the lowest shelves. There should be a fire resistant cupboard for highly flammable liquids (for safety reasons) and ideally a locked cupboard for the more hazardous chemicals (for security reasons).

Where it is not possible to have a chemical store there should at least be a suitable cupboard in the preparation room itself for highly flammable liquids, a locked cupboard for toxic chemicals and one for corrosives. It is good practice to have locked cupboards for other hazardous chemicals too and also for other hazardous items (e.g. scalpels).

---

#### Notes

<sup>1</sup> BB88 'Fume Cupboards in Schools' 1998, published by The Stationery Office.

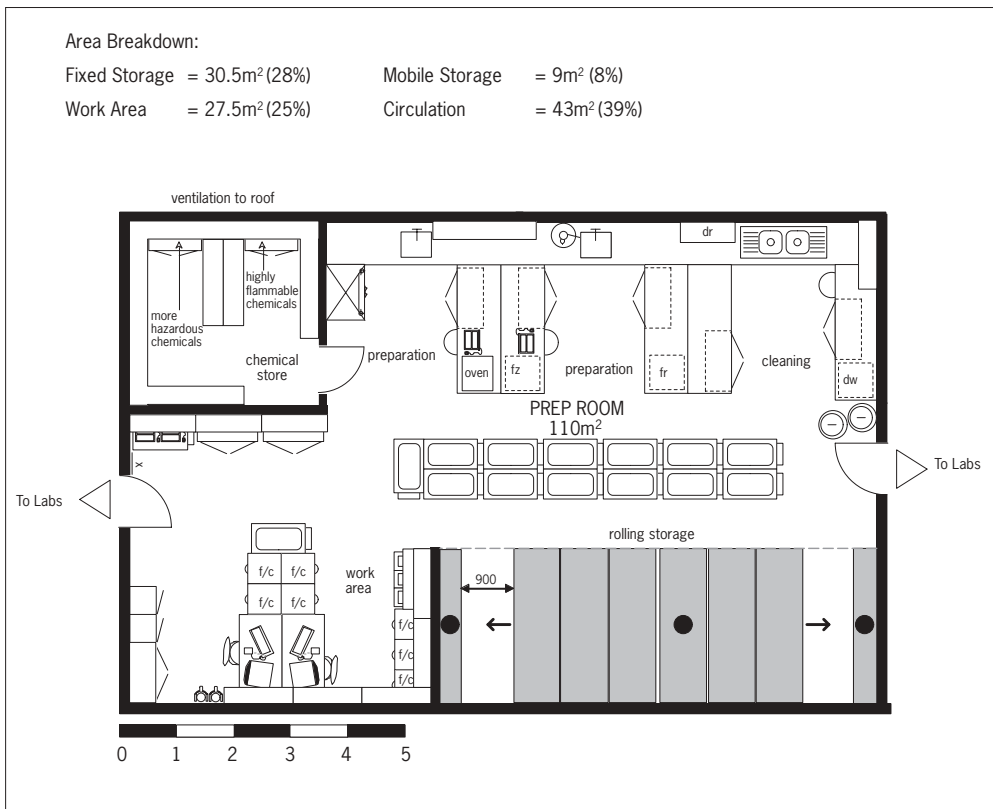
<sup>2</sup> A Step by Step Guide to COSHH Assessments (revised edition), HSG 97, published by HSE books, 1999 and Control of Substances Hazardous to Health Regulations 2002, published by HSE books.

<sup>3</sup> Management of Health and Safety at Work regulations 1999, published by the Stationery Office.

<sup>4</sup> Dangerous Substances and Explosive Atmospheres regulations 2002, published by the Stationery Office.

<sup>5</sup> 'Storage of dangerous Substances' one of the approved Codes of Practice and Guidance accompanying the DSEAR regulations, 2002, published by HSE books (ref L135).

<sup>6</sup> See CLEAPSS Laboratory Handbook, section 7.3, CLEAPSS 2004.



**Figure 3/2**  
Example A: Central Preparation Room to Serve 7 Laboratories

**Radioactive materials**

Radioactive materials must be stored separately from highly flammable materials in a locked cupboard or store. Such materials should be stored and used in accordance with AM 1/92<sup>7</sup> which states that in order to limit exposure time these materials should be stored in an area not used regularly by the same people.

**Layout Examples**

These two sample layouts show how the principles outlined above can be applied to preparation facilities serving a group of seven laboratories. Both examples provide a total of 0.5m<sup>2</sup> of floor area for each science workplace, and assume that only a small amount of local storage is provided in the laboratories.

**Example A:**

**A Central Preparation Room.**

Figure 3/2 shows a central preparation room which is organised on the zoning principles described earlier. Below are some particular points to note about the plan.

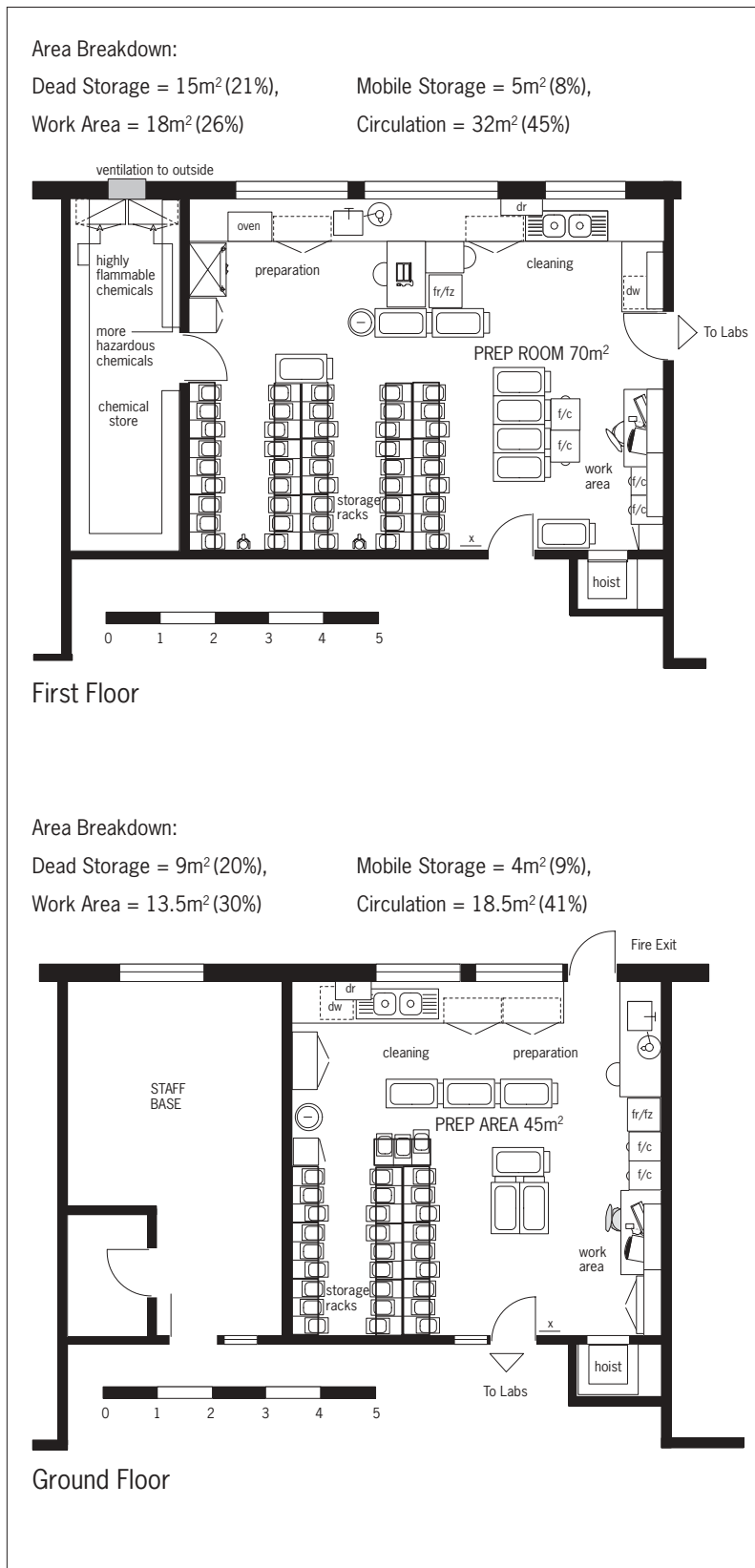
- Access is from each end of the room, opening directly onto the central trolley park.
- A rolling storage system is shown, divided into two halves by a fixed unit allowing two technicians to have access to different units at the same time.
- The main work area is divided into 3 zones: cleaning, general preparation and chemical preparation. The latter zone includes a fume cupboard adjacent to the chemical store.
- The cleaning area is separated from the preparation area and positioned next to one of the entrances.
- This room provides 8m<sup>3</sup> of storage for each laboratory<sup>8</sup>, i.e. 56m<sup>3</sup> in total.

**Notes**

<sup>7</sup> AM 1/92: The Use of Ionising Radiations in Education Establishments: DFE, 1992.

<sup>8</sup> The volume calculated assumes a maximum storage height of 2 metres.

## Section 3: Support Spaces



### Example B: Preparation on Two Floors.

Figure 3/3 illustrates the preparation facilities for a two floor science department with a preparation room on each floor. There are particular points to note about these two plans.

- The size of each preparation room relates to the number of laboratories it serves. The larger preparation room also contains the chemical store.
- The facilities are generally divided according to the number of laboratories served on that floor. There are some duplications including a fridge, a wash-up sink, a science sink, a dishwasher, a distillation unit and fire fighting equipment.
- Less frequently used items, such as the fume cupboard, are not duplicated.
- The hoist enables equipment to be transported conveniently between the two floors. The hoist would need to be designed to prevent the spread of fire up the shaft. Alternatively a nearby passenger lift could be used.
- As these preparation rooms are on an external wall the technicians have an outside view but the different activity zones cannot be as efficiently organised as in the previous example.
- Simple racking units are shown for storage since the size of each preparation room does not warrant a rolling storage system. As a result, the total volume of storage is 7m<sup>3</sup> per laboratory (49m<sup>3</sup> in total), a little less than that provided in Example A.

**Figure 3/3**  
Example B: Preparation on  
Two Floors in 7 Laboratory  
Suite

## The Staff Base

The requirements for local staff accommodation will vary from school to school. Figure 3/4 shows a possible arrangement for a staff base serving seven laboratories. There is sufficient space for up to seven members of staff to prepare work, hold meetings, or make refreshments. Facilities shown here include a computer, photocopier, telephone and sink. An adjacent lockable store may hold pupils' work retained for assessment purposes, record cards or any other items needing secure storage.

## The Greenhouse

If a greenhouse is to be provided it can form an interesting and attractive extension to a science department. A small conservatory or Wardian window, a secondary glazing unit which provides a self-sustaining environment, may be considered as an alternative.

## Location

A greenhouse is best located fairly close to the science suite to encourage its use and allow easy maintenance and supervision. The site will need to receive plenty of sunlight and be protected from the wind.<sup>9</sup> If it is over-looked by other buildings the possibility of vandalism will be minimised.

## Form and Material

The size of the greenhouse depends very much on the use that will be made of it. The structure can be of timber or aluminium, the latter requiring less maintenance. The glazing can be of glass, polycarbonate or acrylic. Polycarbonate is more expensive than acrylic although it is more hard-wearing, less brittle and does not discolour. Glass, although more easily broken, is better at transmitting light and does not deteriorate in the same way as acrylic.

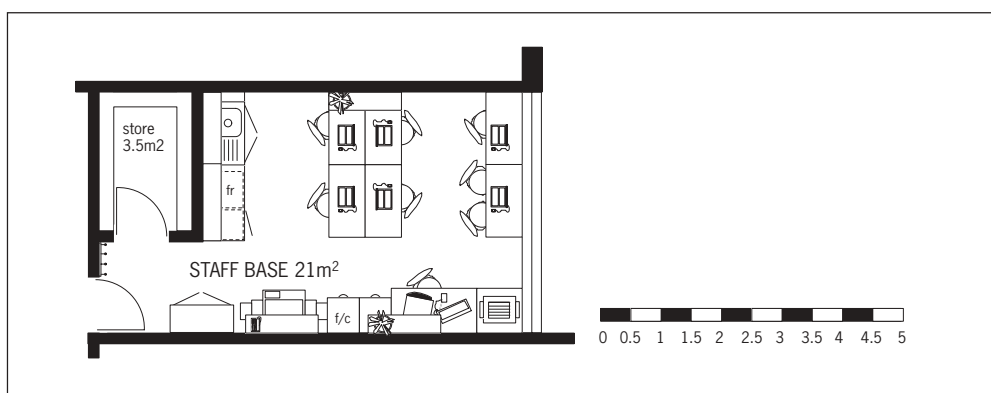
## Environment and Services

The greenhouse will need to be ventilated and various automatic window opening devices are available. It may be heated although this will add to the cost. Free standing heaters should never be used because of the danger of fire.

An automatic watering device is not essential but there should be access to water within the greenhouse. Any electrical socket outlets must be waterproof.

### Note

<sup>9</sup> 'BB71 The Outdoor Classroom Educational Use, Landscape design and managements of school grounds' 1999, published by The Stationery Office.



**Figure 3/4**  
Staff Base

# Section 4: Furniture, Equipment and Finishes

This section provides general guidance on the furniture and equipment shown on the layouts in Section 2. It is worth noting, however, that each of the servicing systems outlined in that section has its own particular furniture requirements whether loose or fixed. This section also includes information on suitable finishes for science spaces.

## Notes

<sup>1</sup> BS EN 14056. Laboratory Furniture - Recommendation for Design Installation.

<sup>2</sup> Furniture and Equipment in Schools: A Purchasing Guide DfEE 2000.

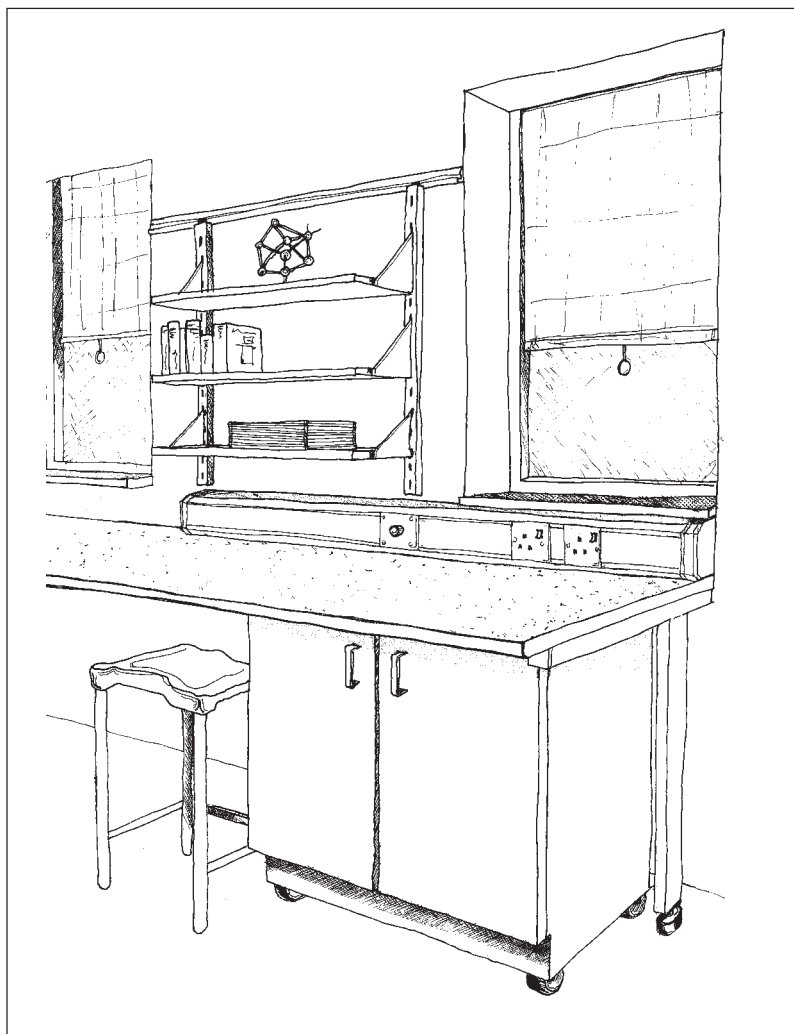
<sup>3</sup> Work with Display Screen Equipment. L26 HSE Books.

Any furniture that will be used in a school laboratory should comply with all the relevant and current British Standards. BS 3202 is a wide ranging standard which deals mainly with the construction of science research laboratory furniture, but it is a useful reference. The standard is in four parts, however Part Three has been replaced by BS EN14056<sup>1</sup> which covers the safe distances between furniture. This information forms the basis of the dimensions given in Section 2.

**Figure 4/1**

Co-ordinating Furniture and Services

A clear specification, which includes appropriate standards, is an essential part



of the tendering process for laboratory furniture. Unless schools are clear about exactly what they want the tender exercise will be unreliable and quality may not be assured. The DfES's 'Furniture and Equipment in Schools: A Purchasing Guide'<sup>2</sup> provides a useful guide to the tender process as well information on various types of furniture and guidance on how to ensure safety and quality. The guide, which also gives a sample specification for a tender exercise, can be downloaded from <http://www.teachernet.gov.uk/fande>.

## Tables and Benching

### Dimensions

It is important to consider the smaller pupil when designing or specifying laboratory tables and benching because a bench which is too high may prevent a pupil from working safely with a Bunsen burner. 900mm is generally considered a suitable height for a laboratory work surface for KS3 and 4 pupils. Stools must correspond in height to the worktop. A measurement of 240-270mm from the top of the stool to the underside of the worktop allows sufficient thigh clearance for the pupil to sit comfortably at the work surface. In preparation areas benches must be positioned at a height sufficient to take standard appliances such as dishwashers and fridges underneath. A common height is 920mm which suits most adults.

A working depth of 600mm for benching and tables is recommended. In any situation service outlets should be positioned no further than 600mm from the front of the bench. There should be sufficient space underneath to allow stools to be safely tucked away during experiments. Desktop computers may require a depth greater than 600mm, 750mm deep is usually appropriate. Laptops (and some flat screen computers) require less table space than desktops, however to comply with the health and safety guidance<sup>3</sup> there should be a reasonable distance between the laptop screen and the user.

A table of 1200 x 600mm generally provides the minimum recommended working area for KS3 and KS4 pupils, however some systems where service outlets are part of the working surface can provide less overall area. Section 2 looks at the working area for each system as part of a comparative analysis exercise.

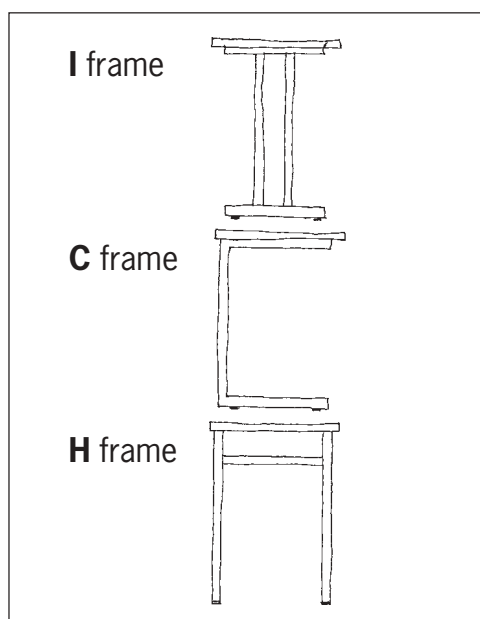
Separate trunking containing gas, electrical and water services, may run around the perimeter of the room sited above or below the side benching. Careful co-ordination will be needed where fitted workbenching and trunking runs above a radiator or beneath a window (see Figure 4/1).

### Furniture Frames

Various frames in both wood and metal are available for side benching, serviced units and loose tables. Frame shapes vary but metal frames are generally cantilevered whilst wooden frames are usually the more traditional four-legged shape. For systems where loose tables may be positioned around serviced units four legged frames are more suitable as they allow pupils to sit at the end of the table.

Cantilevered frames can be useful with wall benching as there are no legs at the front to prevent pupils sitting anywhere along the bench. Figure 4/2 shows frame shapes used in various science systems installed in schools today.

The needs of pupils with disabilities must be taken into account. At least one adjustable height table should be provided in each area to allow disabled pupils to carry out a variety of activities. The table should be easily and discretely adjusted and not rely on separate mechanisms which may become lost. The table top may need to be shaped to support some pupils during practical experiments. For some serviced systems it is necessary to offer distinctly different tables for disabled pupils, whilst others are more able to incorporate an



**Figure 4/2**

Frame Shapes for Laboratory Tables

adjustable table into the overall scheme (see Section 2). Specialist advice must be sought on this issue.

### Work Surface Materials

Resistance to water penetration, chemical attack, heat and impact are critical to work surfaces in a science laboratory. BS 3202 sets down general standards for surface strength and resistance based on a number of tests. The Consortium of Local Education Authorities Providing Science for Schools (CLEAPSS) have also carried out tests specific to school science based on this British Standard on a range of bench materials.<sup>4</sup>

Manufacturers sometimes use a different finish on the perimeter work surface from that on the main serviced furniture system, assuming that less practical work will be carried out on the perimeter. This is often not the case and the suitability of these finishes should therefore be carefully checked.

Overleaf is a brief description of the most widely available materials and their properties, divided into their two main categories of wood and synthetics.

### Note

<sup>4</sup> CLEAPSS L14 Designing and Planning Laboratories'

### Wood

Iroko is often used for bench and table tops. It is a very durable wood and if correctly sealed it has good resistance to water and most chemicals, although it can be marked by heat. All seals, however, need to be adequately maintained to prevent water or chemicals reaching the wood itself. Wood has the advantage that it may be sanded and re-polished during refurbishment.

Iroko comes from trees in tropical rain forests and partly for this reason it is less used than it once was. Schools may wish to purchase iroko which has come from a sustainable source. An alternative is a material made up of small sections of iroko laminated together. These small sections come from younger trees helping the development of a sustainable resource. Their resistance to long term attack from water and chemicals on the binder should be discussed with the manufacturer.

### Synthetics

There are two main types of plastic used for worktops: homogeneous and laminated. Homogeneous synthetics include:

- cast epoxy resins;
- polymethacrylates;
- polyesters.

Laminated plastics are made up of layers of paper impregnated with resins. There are two main types:

- solid laminates;
- laminates on a chipboard base (laminated in a variety of thicknesses).

All the homogeneous synthetics have good all-round resistance but cast epoxy resin is the strongest material. The polymers may be stained by certain chemicals or excessive heat. The mottled surface finish of some of these materials can help to mask stains. Using a grinder

on certain materials can help remove stains, a resin filler can then be used to fill in the 'hole', but a certain degree of skill is required to re-sand to a similar smooth finish as before.

Solid laminates have a similar resistance to the polymers. Laminates which are on a chipboard or similar base are less suitable for laboratory use (particularly when the laminate is thin) because the layer of laminate can be damaged exposing the porous base layer. Solid laminates are a series of paper laminates bonded together to form a solid material. They have the advantage that they are stronger than laminate on a chipboard core, less impervious to water penetration and can be cut to any shape as there is no need for a separate edge. The top surface can be damaged, but if this happens it does not reveal a weaker and more porous core material as does laminate on a chipboard base.

The material used on the serviced system has the greatest impact on the cost of a laboratory. Generally, the cost of materials can be identified in the following order with the lowest first:

- 1: Iroko.
- 2: Solid Laminate.
- 3: Cast Epoxy.
- 4: Polyester.
- 5: Polymethacrylate.

Some materials may attract greater fitting costs, although that will depend on the system being used, as some systems can be manufactured completely off-site. The cost of fitting out a laboratory is also dependent on the size of the room, with the type of system and manufacturer having far less impact.

### Service Outlets

#### Gas

Gas taps must be securely fixed in such a way that they cannot rotate, thereby preventing pupils from twisting the pipes and fracturing the gas connections. Some vandal resistant taps are now available however, with a non-return valve. Taps should also have a clearly defined on and off position, controlled by a double action method (e.g. depressing and turning) to avoid pupils turning them on by accident. Drop lever taps are preferable as teachers are able to see from a distance whether taps are on or off.

#### Power

Double socket electrical outlets should be switched. Sockets should not be positioned horizontally and should ideally either be angled or protected by an overhanging work surface with non-drip groove. The way in which sockets are positioned near to sinks should be carefully considered. All pipe work to sinks should be cross-bonded.

#### Water

Non-rotating sink taps avoid splashing and pupil misuse and are advisable with good quality, high level spouts to allow tall glassware to be filled. Various tap materials are available but an epoxy coat is suggested due to its overall resistance to corrosion.

#### Sinks

Wash up sinks are usually manufactured in stainless steel. The steel must be of an acid resistant grade adequate for laboratory use although undiluted chemicals should never be poured into these sinks. Small sinks which are used for science practical work are generally available either in fireclay or a synthetic material. Fireclay has good resistance to most chemicals and heat, it is easy to maintain and has a long life. However, it is a hard material and glassware is more likely to break if dropped into a fireclay sink than one made from one of the following synthetic materials.

- Cast epoxy: the same properties of high resistance as a worktop in the same material. A sink unit is either inset into the bench top and the joint sealed with a sealant, or it forms a complete unit with a drainer.
- Polymethacrylate: used where this is the bench material and a continuous joint free surface is achieved. Staining may be caused by certain chemicals.
- Polypropylene: these sinks are inset and lipped and although they have good chemical resistance they can be damaged by heat.

Bottle traps to sinks will allow easy clearance in the case of blockage. If regulations concerning the disposal of chemicals are followed, dilution traps should not be necessary. Non-corroding polypropylene waste pipes are recommended.

### Storage

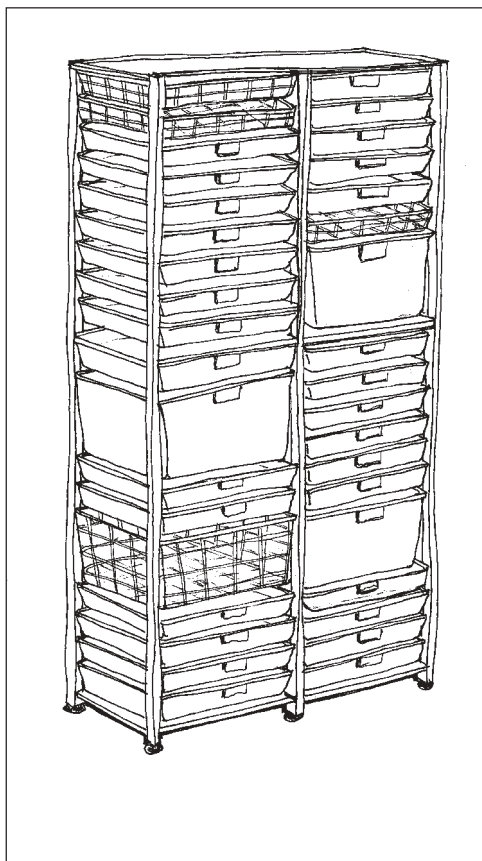
#### Resources and Equipment

The laboratory layouts in Section 2 show storage for basic resources for up to 30 pupils which is additional to the storage in the preparation area. The majority of storage cupboards, with either adjustable shelving or trays, are shown stored under worktops. Tray units are the best solution under side benching as they can be pulled out enabling resources to be seen more easily. Adjustable shelving and glass fronted wall cupboards providing storage above the benching is also shown. Under bench storage units should ideally be mobile (see also Section 2). This allows units to be re-arranged within the laboratory, moved to another laboratory or to the preparation area. Mobile storage units also allow laboratory floors to be cleaned more effectively and, when stored under benching, moved to create 'knee holes' when pupils wish to sit at the perimeter benching (see Figure 4/1).

## Section 4: Furniture, Equipment and Finishes

**Figure 4/3**

Racking Storage System



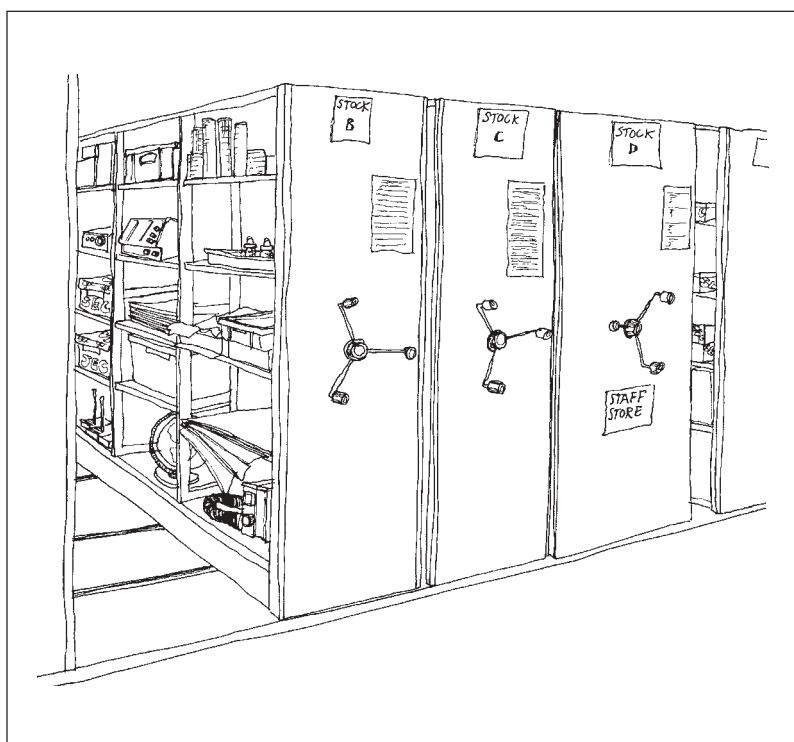
Where storage in the preparation area is minimal, full height cupboards may be used in the laboratories to increase storage capacity. They can be compatible with other lower height cupboards and trolleys and are often more economical in overall cost. However, they are not usually mobile, they do not provide a horizontal work surface, can cause congestion if all pupils want to access the resources at the same time and, if there are several, they can reflect sound from their laminate or metal doors.

The bulk of science equipment is generally stored in the preparation room. Storage systems which offer a range of interchangeable trays are particularly useful because science equipment comes in a variety of shapes and sizes. The racking system shown in Figure 4/3 can accommodate shelves, wire baskets or plastic trays. Science equipment can often be heavy and it is advisable to place trays carrying this equipment on shelves.

Figure 4/4 shows the rolling unit system described in Section 3. If this furniture is used, the floor must be designed to allow trolleys to run smoothly between units. The floor must also be strong enough to take the additional weight of the system.

**Figure 4/4**

Rolling Storage System



Equipment trolleys are widely used for storing and moving resources. 1000 x 500mm is a typical size which is compatible with standard storage units. Trolleys may carry trays or shelves. Trays are particularly useful because they are also used in storage cupboards in the preparation area and the laboratory and can be placed on a trolley to be transported between the two areas.

Care must be taken in the storage of items which are fragile (such as glassware) and items which may require specialised storage units such as eye-protective goggles. The flexibility of each storage system should be borne in mind.

Wall rail systems are sometimes used in laboratories; metal uprights hung from any point along the length of a horizontal

rail carry cupboards or shelving brackets. Whiteboards can be hung directly from the wall rail. This system allows units to be positioned anywhere along a wall and changed (if required) at a later date (see Figure 4/5).

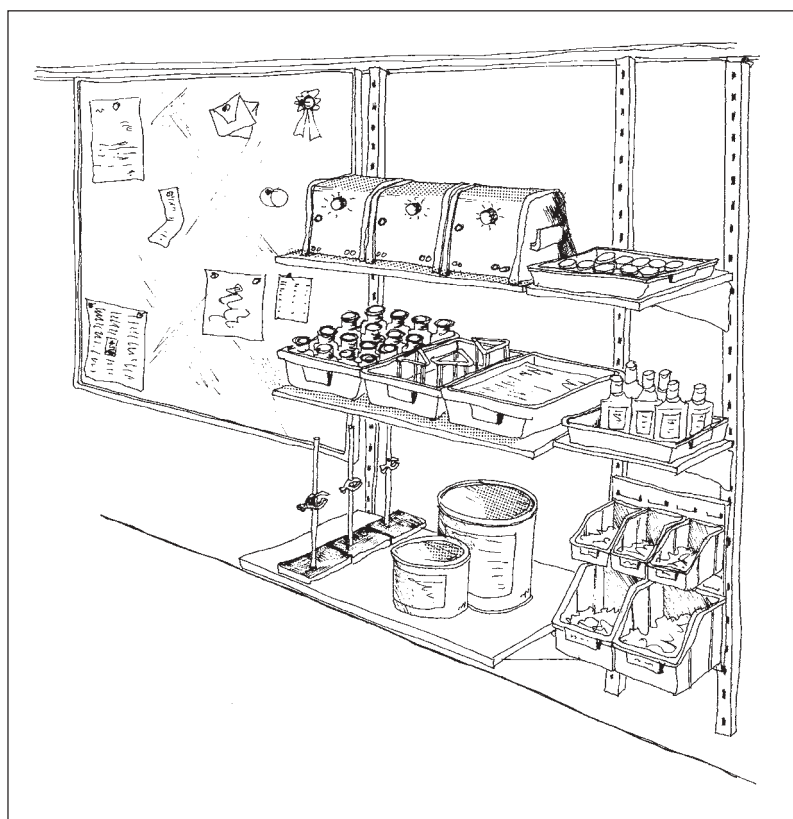
### Pupils' coats and bags

The method of storing pupils' personal belongings differs from school to school and this should be identified early on in a project. Some schools provide lockers for pupils books with storage for their coats only in classrooms. Some schools provide lockers large enough to store coats and bags and storage in classrooms is only required for resources needed for the lesson in progress. If pupils' coats and bags are to be brought into the laboratory they must not, for health and safety reasons, cause obstruction. In all the laboratory layouts in Section 2, an area is shown near to the entrance for storing outdoor coats, bags and laboratory coats. Schools may wish to consider housing two smaller units in different parts of the room to avoid congestion, but as there is more than one zone to consider, this does make spaces more difficult to organise.

Free-standing units are the most flexible approach to coat and bag storage, allowing for re-arrangement of the room. Units which contain a series of open 'box like' shelves encourage a more organised environment, particularly if it is only bags which require storing. It is important that each 'box' is big enough so that bags do not overflow onto the floor and that there are sufficient 'boxes' for the maximum number of pupils who will use the room at any one time.

### Display

Display is an important aspect of any classroom environment providing both visual stimulation and a sense of achievement to pupils. Vertical display may be in the form of loose boards or permanent pinboard wall covering. Work surfaces and cupboard tops provide



**Figure 4/5**  
Wall Rail Systems

excellent horizontal surfaces for displaying three dimensional objects. Delicate objects which are of interest to the pupils may need to be kept in glass fronted wall hung cupboards.

The flexible wall rail system illustrated in Figure 4/5 can be used for display as well as storage. This system enables the teacher to choose how the classroom environment should function.

### Stools

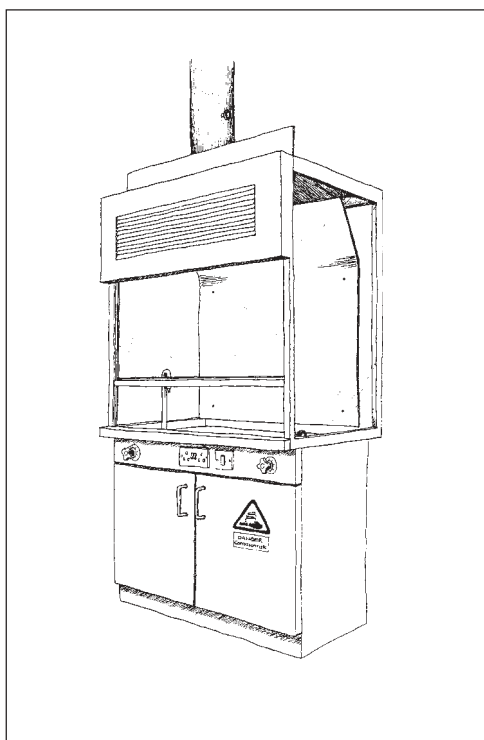
Stools are available with a wooden or metal frame. The finish of the seats should be carefully considered, sealed wood or polypropylene are particularly useful. Shaped seats are generally more comfortable for students. Plastic end caps or bungs must be firmly positioned as, if removed, the metal legs can scrape and damage floor surfaces. Similarly end caps can be damaged by the metal particles in non-slip flooring. Check with furniture manufacturers for an assurance of quality on this important component. 'Skid base' chairs which have a continuous metal frame, bent in three places to form a square shape, may be more appropriate.

## Section 4: Furniture, Equipment and Finishes

'Skid base' chairs are considered less susceptible to damage than a four legged frame because weight is distributed evenly across the frame rather than on four legs. It is important to check their stability on uneven floors, however, unless they have a levelling plastic cap.

**Figure 4/6**

Fixed Fume Cupboard with vented corrosives cabinet underneath



### Fume Cupboards

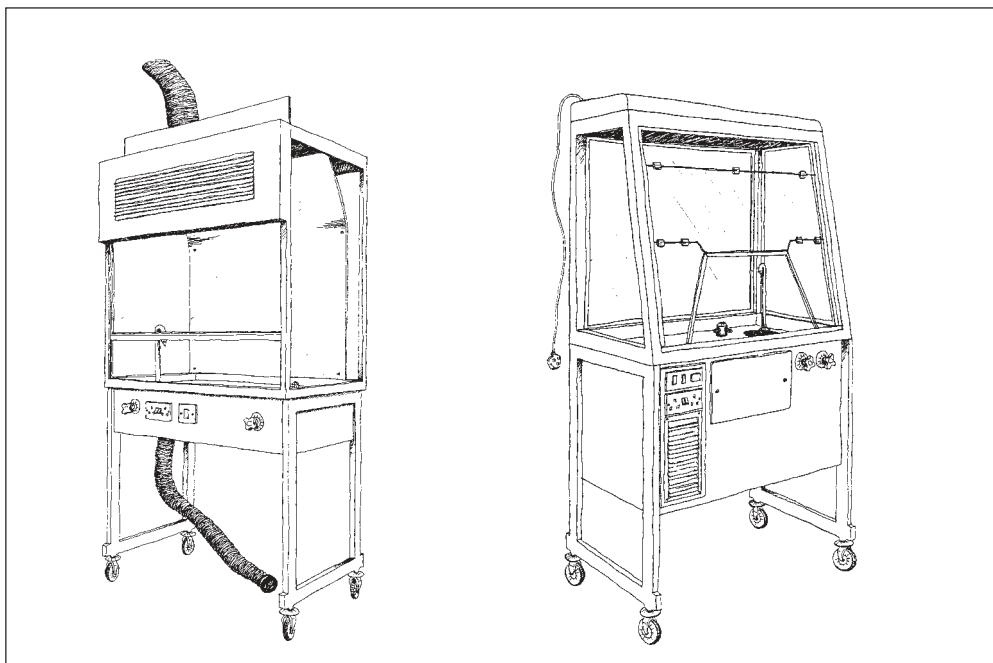
Fume cupboards may be either fixed (Figure 4/6) or mobile (Figure 4/7). Building Bulletin 88 'Fume Cupboards in Schools' looks in detail at the pros and cons of different types of fume cupboard (as well as containing valuable guidance on specifications, maintenance and commissioning). The main advantages of a mobile fume cupboard are ease of access for demonstration purposes and economy of use (one unit can be shared between a number of laboratories). The room layouts in Section 2 indicate a position for a fume cupboard (assumed to be mobile) in every laboratory.

Mobile fume cupboards may be of the ducted or re-circulatory type. The ducted type has to be attached to a fixed extraction system whereas the re-circulatory type, being self contained, can be used anywhere, making it particularly useful in conversion schemes. Ideally ducted fume cupboard suppliers should also install the ducting and extraction system and commission the work.

Re-circulatory fume cupboards are less expensive to buy initially and offer the greatest flexibility, particularly as one fume cupboard can be shared across a

**Figure 4/7**

Mobile Fume Cupboards- Ducted and Recirculatory



number of laboratories. However they contain filters which need to be replaced at regular intervals. They are legally required to be tested for saturation. Testing filters is, in many cases, a skilled job and schools will need to invest in specialist equipment if they wish to do it themselves. Specialist advice must be sought on this issue. Long-term recurrent costs must be considered alongside initial capital outlay.

To ensure flexibility, the overall size of a mobile fume cupboard may need to be checked against door opening sizes. This must be planned at the start of a project so the choice of fume cupboard should be made very early on. There are a number of documents providing information on all types of fume cupboard (see References).

### Finishes and Fittings

Fire resistance must be borne in mind when choosing finishes and fittings for a laboratory. Detailed advice must be sought and assurances from manufacturers on the degree of fire resistance of their products should be obtained.

#### Flooring

Generally the following characteristics are important when specifying flooring for a laboratory or preparation area:

- Slip resistance.
- Strength and resistance to wear.
- Chemical and stain resistance.
- Resistance to fire.
- Resistance to static.
- Hygiene.
- Appearance.
- Cost (initial capital cost and maintenance cost).
- Maintenance.
- Acoustic properties.

Slip, stain and chemical resistance are particularly important considerations in highly practical areas such as science laboratories and preparation rooms. Water and other liquid spillages can make

a floor slippery. Flooring often relies on a rough surface to ensure slip resistance, which can be at odds with floor cleaning. Schools should always follow the advice of the manufacturer on the recommended cleaning method and use appropriate proprietary cleaning products. In certain circumstances using inappropriate cleaning methods may damage the surface finish. Prevention is preferable to repair, i.e. using adequate cleaning regimes, lessening the likelihood of spills and using matwells in external doorways to prevent mud and dirt entering the building.

Long term maintenance costs should be borne in mind, the initial cost of flooring can soon be off-set by excessive time spent cleaning with an inappropriate cleaning product.

Uneven floors may lead to tripping and in some cases slipping incidents, if water spillages create pooling. Highs and lows in the floor may lead to excessive wear in certain places, which may even erode the slip resistance of the flooring. Uneven floors also present problems if tables are frequently re-arranged as they can become unstable.

The use of anti-static flooring is recommended, particularly in areas with a high level of electronic and electric components. Legislation does not cover flammability of flooring but as floor finishes can contribute to the spread of a fire the degree of fire resistance should be identified.

Schools should confirm with floor manufacturers whether fixed furniture and equipment should be installed before or after flooring is fitted. Typical flooring types are outlined below.

### Vinyl

Vinyl is available in sheet or tile form. It is waterproof and impervious to most chemicals, but further detail on this must be sought from the manufacturer. It is a relatively soft material and can be cut fairly easily making it vulnerable to metal legs without plastic end caps on stools and chairs. Thicker vinyls provide more sound absorption. As staining can occur over time it is best to avoid light colours. Sheet vinyl is relatively easy to lay but joints must be kept to a minimum and well sealed to ensure that water or other liquids cannot permeate to the underside. Vinyl tiles have the advantage that they can be replaced easily if damaged but they can curl, tear or de-bond more easily. Slip resistant versions are available, often with small particles of silica embedded into them. The texture of this finish can make this flooring more difficult to clean than standard vinyls (see discussion above) and it is important that the most appropriate cleaning method is used following manufacturers recommendations. The rough surface of the floor can also damage ferrules in stools (see pg 43). Good maintenance will help to ensure flooring retains its safety characteristics.

### Linoleum

Linoleum is made from renewable ingredients and natural raw materials, which makes it a more sustainable material. It is available in both sheet and tile form. Linoleum has anti-static properties added and offers resistance to most common chemicals, although this must be verified with the manufacturer. The material is soft and therefore offers some acoustic qualities. A wide range of colours and new cutting techniques allow for numerous inlays and floor patterns, some of which can be beneficial for pupils with visual impairments.

### Ceramic and quarry floor tiles

Ceramic floor tiles are available in a variety of sizes and shapes and can have a patterned relief which provides some slip resistance. Specialist skirting tiles may be useful where floors are washed frequently. However, ceramic tiles are hard making them noisy, less comfortable for teachers who stand on them all day and unrelenting to delicate objects which may be dropped on the floor. Larger tiles are more likely to crack particularly on an uneven floor. As tiles can be grouted with a non-slip filling, smaller tiles will be more advantageous.

Quarry tiles are usually unglazed and will therefore stain with oils. However, they are very hard wearing, easy to maintain and impervious to chemicals making them particularly suitable for use in a chemical store. Slip resistant versions should be used in any science areas.

### Other Flooring

Rubber flooring is hard wearing and warm. A variety of relief patterns give it a non-slip quality but as dirt can build up around the patterns, appropriate cleaning is essential.

Sealed wooden flooring is durable and less hard than ceramic tiles but as frequent wetting causes swelling and warping proper maintenance is essential. Wood block flooring can be used if the surface is fully sealed but it is essential that a non-slip polish is used.

Occasionally concrete floors are specified in laboratories. If so they must be sealed as even plain tap water can degrade concrete after a certain amount of time. Unsealed concrete will shed dust over a period of time which then in turn acts as an abrasive coating to create more dust. Again this can be avoided by sealing the concrete. Concrete is a hard material which is unlikely to be appropriate to creating a comfortable learning environment.

### Walls, windows and doors

Maintenance is a key factor in the choice of wall finish throughout a school. Painted matt surfaces are generally more difficult to clean. Dado rails are useful to prevent damage to walls at chair and table height. Solid laminate is an ideal material to use as it requires little machining. The cost of the rails may be off-set against savings on decoration costs.

Some form of sun and daylight control is likely to be needed on most windows, particularly where dim-out is required. Blinds may be vertical, horizontal or roller although, all three types are susceptible to damage. Horizontal blinds are the most controllable but they do gather dirt. Metal slats on south facing rooms can heat up and act like radiant panels. Vertical blinds are cheaper and easier to clean but are more delicate and offer less controllability. Roller blinds provide some lighting control but this cannot be combined with a view out for pupils. Some laboratories may need black out blinds for certain experiments. The need for black out should be carefully considered however as they require a casing and are expensive.

Fabric blinds fitted above benching containing sinks must be waterproofed. It should not be possible for blinds to blow against lit Bunsen burners when windows are open - a way of containing them should be identified. For safety and to avoid damage, pull cords on all blinds should always be tidied away.

Vision panels in doors are particularly valuable in laboratories where maximum supervision is needed. Vision panels in internal doors and doors between laboratories are necessary in case of fire. Consider vision panels at a lower level for wheelchair users, with a centre line around 1000-1200mm.

# Section 5: Environmental Design and Services

As science is essentially a practical subject, Health and Safety regulations and environmental conditions are particularly important. Science laboratories are heavily serviced rooms and the design and coordination of all services must be considered at the outset. This section describes some of the main issues to be considered but reference should be made to all the relevant statutory documents and additional guidance listed here and in the references section.

## Environmental Design

### Acoustics

The surfaces finishes of floors, walls and ceilings should be chosen to achieve a reverberation time of less than 0.8 seconds as specified in Section 1 of Building Bulletin 93<sup>1</sup>. A longer time will result in a loss in speech intelligibility. This is especially important for pupils with hearing impairments.

### Ventilation

Ventilation of science laboratories must be designed to provide adequate ventilation for occupants and to dilute fumes and water vapour generated, e.g. during experiments using Bunsen burners. The Education (School Premises) Regulations 1999<sup>2</sup> give ventilation rates which allow for occupancy of teaching spaces. These require that:

“Controllable ventilation should be provided at a minimum rate of 3 litres of fresh air per person per second for each of the maximum number of persons the area will accommodate” and that

“the spaces should be capable of being ventilated at a minimum rate of 8 litres of fresh air per second for each of the usual number of people in the space”.

The Workplace Regulations<sup>3</sup> also apply during use and require that:

“The fresh air supply rate should not normally fall below 5 to 8 litres per second, per occupant. Factors to be considered include the floor area per person, the processes and equipment involved, and whether the work is strenuous”.

The risk assessments for pollutants generated by science experiments conducted in the open laboratory assume a room volume of 200m<sup>3</sup> and at least 2 air changes per hour for a typical science laboratory<sup>4</sup>. However, if the ceiling height is low a higher ventilation rate will be required to achieve the same air change rate.

In most laboratories and preparation rooms some form of mechanical ventilation will be required at least some of the time to deal with pollutant loads and the heat gain and water vapour produced by Bunsen burners and other equipment and solar gains. Hybrid mechanical/natural ventilation systems rather than full mechanical ventilation systems will probably be the most economic solution. Heat recovery on local extract fans and on supply and extract systems is recommended to minimise ventilation heat losses.

Where ducted fume cupboards are used, there needs to be an adequate supply of incoming air to compensate for the extraction when the cupboard is in use. All fume cupboards should be installed and used according to the guidelines laid down in Building Bulletin 88.<sup>5</sup>

### Lighting

A good general level of illuminance (e.g. 300 lux) is recommended for all teaching rooms in Building Bulletin 87.<sup>4</sup> It should be possible to control groups of lights separately particularly those over the projection screen or whiteboard. Additional local task lights may be useful for certain experiments. Dark shiny work

#### Notes

<sup>1</sup> Building Bulletin 93, 'Acoustic Design for Schools', The Stationery Office, 2004

<sup>2</sup> 'The Education (School Premises) Regulations', The Stationery Office 1999.

<sup>3</sup> 'Workplace Health, Safety and Welfare Regulations 1992: Approved Code of Practice and Guidance', L24, HSE Books, 1996.

<sup>4</sup> See the latest version of Building Bulletin 87, 'Guidelines for Environmental Design in Schools' at: [www.teachernet.gov.uk/energy](http://www.teachernet.gov.uk/energy)

<sup>5</sup> Department for Education and Employment, Building Bulletin 88 'Fume Cupboards in Schools' (Revision of DN 29). The Stationery Office 1998.

<sup>6</sup> Department for Education and Employment, Building Bulletin 90 'Lighting Design for Schools', The Stationery Office 1999.

surfaces are best avoided as they can cause glare. Very dark colours may provide too great a visual contrast. Further details can be found in Building Bulletin 90, 'Lighting Design for Schools'.<sup>6</sup>

Laboratories will need some form of blinds to reduce the daylight in the room when an electronic whiteboard, OHP or video is in use or to control reflections on computer screens. One laboratory may need black-out facilities for light experiments; a dimming facility is also useful.

### Heating

As with all services the position of heating outlets should be coordinated at an early stage with the furniture and equipment layout of the room. This is particularly important where heating units occur under worktops. Detailing must allow for adequate air movement which may mean leaving space in front of the unit and designing the worktop to allow for an air grille above each one.

### Services

All services should have a master control panel, which should be located near the main teaching (demonstration) position. This allows the teacher to control access to services as required and also to shut off any or all in the event of an accident.

### Electricity

All installations must comply with the latest regulations from the Institute of Electrical Engineers (IEE).<sup>7</sup> The safety of electrical systems should not be compromised by electrical wiring contained in furniture systems and particular care must be taken with correct earthing and the safe isolation of electrical faults. This is especially important when adapting existing accommodation. Where servicing systems include flexible cables there must be some form of physical restraint.

Most laboratories are now fitted with mains supply and transformers are used locally for low voltage experiments. Protection by residual current devices (RCDs) is recommended. The current is switched off automatically in the case of a fault. One circuit usually controls one laboratory. A central push button isolator is also useful and should be easily accessible to the teacher but not to pupils.

### Gas

Reference should be made to 'Gas Installations for Educational Establishments' (UP11).<sup>8</sup>

There will need to be a manual shutoff valve at the pipe entry to each laboratory and each preparation room. Where this valve is not easily accessible an automatic shut-off system can be used which will also shut down the supply in the event of a leak. This can be restored manually by a switch which should be located near the teacher's position or near the door.

Gas pipes should be installed in accordance with the Safety in the Installation and Use of Gas Systems and Appliances Regulations 1998 and the Approved Code of Practice.<sup>9</sup> With a few exceptions, the regulations require gas pipes to be ventilated along their run either by being exposed or by the enclosure being punctuated to provide adequate ventilation to avoid explosion due to a build-up of gas in the case of leakage.

Gas pipes need to be well supported particularly where they are part of a flexible overhead servicing system or at a height accessible to pupils. UP11<sup>8</sup> gives guidance on gas supply to portable equipment such as mobile fume cupboards and recommends detailed inspection of such equipment at least once a year. It also recommends annual inspection of all gas pipework and controls.

#### Notes

<sup>7</sup> BS 7671: 2001 16<sup>th</sup> Edition Requirements for electrical installations, IEE wiring regulations. Published by the British Standards Institution.

<sup>8</sup> Gas Installations for Educational Establishments UP11, published by the Institute of Gas Engineers & Managers, 2004.

<sup>9</sup> 'Safety in the installation and use of gas systems and appliances', Guidance on the Gas Safety (Installation and Use) regulations 1998 and Approved Code of Practice, HSE Books, 1998.

### Fire and emergency precautions

Laboratories and their stores and preparation areas can be high fire risk areas depending on the materials stored and used. Fire extinguishers/blankets should therefore be provided in every laboratory and prep room. The local fire brigade should be consulted on the best types of extinguishers and other fire precautions to be provided; foam, dry powder or carbon dioxide extinguishers are all possibilities. It is worth bearing in mind however that both foam and dry powder would damage electrical equipment after use. CLEAPSS guidance<sup>10</sup> recommends two 2kg carbon dioxide extinguishers are provided in each laboratory. However this should be checked with the local fire brigade. A fire blanket in a suitable container should be provided in every laboratory.

Automatic fire detection is not generally required in science laboratories, however in situations where it is, heat rather than smoke detectors should be specified. This is due to the fact that routine experiments involving Bunsen burners will set off the alarm system if smoke detectors are used.

Alternative means of escape is usually required in science laboratories and can be provided by two corridor doors. Sometimes a door is required between adjacent laboratories and this will compromise the acoustic performance of the wall. However this is allowed under clause 1.2.1 of BB93 which permits alternative acoustic performance standards for specific areas when required for particular educational, environmental or health and safety reasons. If doors form part of an escape route they should always be capable of being easily opened from the side from which escape is required. A lock, if provided, should not require a key to open the door in any direction likely to be used for escape. Prep rooms are likely to need an alternative exit as well as labs although they may be too small to be off a corridor - often it will be to a teaching lab, which may raise security issues.

A fire alarm call point should be provided in or easily accessible to all laboratories. CLEAPSS guidance also recommends the consideration of installation of a plumbed-in eye-wash in new or refurbished buildings.

#### Note

<sup>10</sup> Section 6 of CLEAPSS guide L14, 'Designing and Planning Laboratories', 2000.

# References

---

## General School Design

---

‘Assessing the Net Capacity of Schools’, Department for Education and Skills, 2002, (DfES reference no. DfES/0739/2001 REV).

DfEE Building Bulletin 80 (BB80) ‘Science Accommodation in Secondary Schools: A Design Guide’, Department for Education and Skills, (revised) 1999.

DfES Building Bulletin 98 (BB98), ‘Briefing Framework for Secondary Schools’, Department for Education and Skills, 2004.

‘Disability Discrimination Act 1995. Part 4: Code of Practice for Schools’, The Stationery Office, 2002.

‘Special Educational Needs and Disability Act 2001’ The Stationery Office, 2001.

‘The Education (School Premises) Regulations’, The Stationery Office, 1999.

The Laboratory Design for Teaching & Learning software can be downloaded from the ASE website: [www.ase.org.uk/ldtl/](http://www.ase.org.uk/ldtl/). However, this is a large file and only those with a broadband connection will be able to download it in a reasonable length of time. (A free copy has been sent to secondary schools. Further details, including availability of the software on CD, can be obtained directly from The Association for Science Education).

## Environmental Design

---

BS 5925 ‘Code of Practice for Ventilation Principles and Designing for Natural Ventilation’, British Standards Institution, 1991.

DfEE Building Bulletin 71 (BB71), ‘The Outdoor Classroom: Educational Use, Landscape Design and Managements of School Grounds’, The Stationery Office, 1999.

DfEE Building Bulletin 87 (BB87), ‘Guidelines for Environmental Design in Schools’, The Stationery Office, 1997 (Note: the 2003 version of this Building Bulletin can also be found at [www.teachernet.gov.uk/sbenvironmentalhs](http://www.teachernet.gov.uk/sbenvironmentalhs)).

DfEE Building Bulletin 90 (BB90), Lighting Design for Schools, The Stationery Office 1999.

DfES Building Bulletin 93 (BB93), ‘Acoustic Design for Schools’, The Stationery Office, 2004.

## Health and Safety

---

‘A Step by Step Guide to COSHH Assessments’ (revised edition), HSG 97, HSE books, 2004.

‘Approved Document B – Fire Safety’, The Stationery Office, 2002.

‘Control of Substances Hazardous to Health Regulations’, HSE books, 2002.

‘Five Steps to Risk Assessment’ INDG 163 REV1, HSE books, 1998.

‘Storage of Dangerous Substances: Dangerous Substances and Explosives Atmospheres Regulations 2002. Approved Code of Practice and Guidance’, L135, HSE Books, 2003.

‘The Dangerous Substances and Explosive Atmospheres Regulations 2002’, The Stationery Office, 2002.

‘The Management of Health and Safety at Work Regulations 1999’, The Stationery Office, 1999.

‘Workplace Health, Safety and Welfare Regulations 1992: Approved Code of Practice and Guidance’, L24, HSE books, 1996.

## References

### **Furniture and Equipment**

---

BS 3202 part 1 'Laboratory Furniture and Fittings. Introduction', British Standards Institution, 1991.

BS 3202 part 2 'Laboratory Furniture and Fittings. Specification for Performance', British Standards Institution, 1991.

BS 5873 part 1 'Educational Furniture. Specification for Functional Dimensions, Identification and Finish of Chairs and Tables for Educational Institutions', British Standards Institution, 1980.

BS 5873 part 2 'Educational Furniture. Specification for Strength and Stability of Chairs for Educational Institutions', British Standards Institution, 1991.

BS 5873 part 3 'Educational Furniture. Specification for Strength and Stability of Tables for Educational Institutions', British Standards Institution, 1985.

BS 5873 part 4 'Educational Furniture. Specification for Strength and Stability of Storage Furniture for Educational Institutions', British Standards Institution, 1998.

BS 5873 part 5 'Educational Furniture. Specification for Security of Fixed Secure Storage Furniture for Educational Institutions', British Standards Institution, 1998.

BS EN 649 'Resilient Floor Coverings. Homogeneous and Heterogeneous Polyvinyl Chloride Floor Coverings Specification' British Standards Institution, 1997.

BS EN 14056 'Laboratory Furniture. Recommendations for Design and Installation' British Standards Institution, 2003.

'Designing and Planning Laboratories' L14, CLEAPSS, 2000.

DfEE 'Furniture and Equipment in Schools: A Purchasing Guide', The Stationery Office, 2000.

'Health and Safety (Display Screen Equipment) Regulations 1992 SI1992/2792', The Stationery Office, 1992.

'Work With Display Screen Equipment: Health and Safety (Display Screen Equipment) Regulations 1992 as amended by the Health and Safety (Miscellaneous Amendments) Regulations 2002', L26, HSE Books, 2003.

### **Chemicals**

---

'AM 1/92: The Use of Ionising Radiations in Education Establishments', DFE, 1992, available from the DfES Pupil Safety and School Security Team.

BS 7258 part 1 'Laboratory Fume Cupboards: Specification for Safety and Performance', British Standards Institution, 1994.

BS 7258 part 2 'Laboratory Fume Cupboards: Recommendations for the Exchange of Information and Recommendations for Installation', British Standards Institution, 1994.

'CLEAPSS Laboratory Handbook' CLEAPSS, 2004.

DfEE Building Bulletin 88 (BB88), 'Fume Cupboards in Schools' (Revision of DN 29), The Stationery Office, 1998.

'Do You Work with Chemicals or Other Materials in Educational Establishments', IACL19, HSE books, 1986.

'Managing Ionising Radiation and Radioactive Substances' L93, CLEAPSS, 2001.

### Services

---

BS 1363 parts 1-4 '13 A Plugs, Socket-outlets and Adaptors', British Standards Institution, 1995.

BS 1552 'Specification for Open Bottomed Taper Plug Valves for 1st, 2nd and 3rd Family Gases up to 200 mbar', British Standards Institution, 1995.

BS 5412 'Specification for low-resistance single taps and combination tap assemblies (nominal size 1/2 and 3/4) suitable for operation at PN 10 max and a minimum flow pressure of 0.01 MPa (0.1 bar)', British Standards Institution, 1996.

BS 7671 'Requirements for Electrical Installations: IEE Wiring Regulations' 16th edition, British Standards Institution, 2001.

BS 8313 'Code of Practice for Accommodation of Building Services in Ducts', British Standards Institution, 1997.

'Gas Installations for Educational Establishments' UP11, Institute of Gas Engineers and Managers, 2004.

'Safety in the Installation and Use of Gas Systems and Appliances: Guidance on the Gas Safety (Installation and Use) Regulations 1998 and Approved Code of Practice', HSE Books, 1998.

### Useful Organisations

---

<http://www.teachernet.gov.uk/schoolbuildings>

Association for Science Education (ASE)  
College Lane, Hatfield, Hertfordshire, AL10 9AA  
Telephone: 01707 283 000  
<http://www.ase.org.uk/>






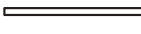
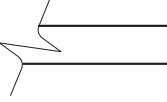

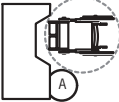

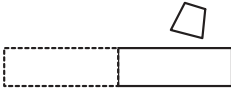












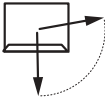


























The British Standards Institute  
389 Chiswick High Road, London, W4 4AL  
Telephone: 020 8996 9000  
<http://www.bsi-global.com/index.xalter>  
For access to British Standards publications.

Consortium of Local Education Authorities for the Provision of Science Services (CLEAPSS)  
Brunel University, Uxbridge, UB8 3PH  
Telephone: 01895 251 496  
<http://www.cleapss.org.uk/>

A nationwide subscription advisory service supporting science and technology teaching in schools. Provides practical advice on matters such as health and safety.

The Health and Safety Executive  
HSE Infoline, Caerphilly Business Park, Caerphilly, CF83 3GG  
Telephone: 08701 545 500  
HSE Books, PO Box 1999,  
Sudbury, Suffolk, CO10 2WA  
Telephone: 01787 881 165  
<http://www.hse.gov.uk/>  
The HSE website has useful health and safety information and publications on topics including wood dust and Control of Substances Hazardous to Health.

# Key to symbols

	1500 Diameter table		Coats and bags storage
	Alternative table position		Fire extinguisher
	Table (various sizes)		Interactive whiteboard
	600 bench		Technicians trolley
	Disabled student table and seat for assistant		Tray unit
	Teacher's serviced workstation with alternative table position		Tray unit under bench
	Stool		Cupboard
	Adjustable VDU chair		Cupboard under bench
	Laptop computer		Cupboard under table
	Desktop computer		Glass fronted wall cupboard
	Laptop trolley		Wall cupboard
	Octagon and sink		Mobile fume cupboard
	Stainless steel washup sink		Fixed fume cupboard
	Double stainless steel sink		Locker
	1800x600 Sink table		Storage tray
	1500x600 Sink table		Distillation unit
	750x750 Sink table		Oxygen and hydrogen gas cylinders
	Wall benching sink		Bin
	1200x600 Bollard		Filing cabinet
	600x600 Bollard		Draining rack
	1500X300 Serviced spine		Dishwasher under worktop
	Pyramid service pod		Fridge under worktop
	Service pod		Fridge/freezer
	Wall serving duct		Laser printer
			Telephone
			Photocopier