

WE THANK YOU
FOR CHOOSING THIS
PRODUCT FROM
SWAROVSKI OPTIK.
IF YOU HAVE ANY
QUESTIONS, PLEASE
CONSULT YOUR
SPECIALIST DEALER OR
CONTACT US DIRECTLY AT
SWAROVSKIOPTIK.COM.

1. OVERVIEW

tM 35 FIELD BAG

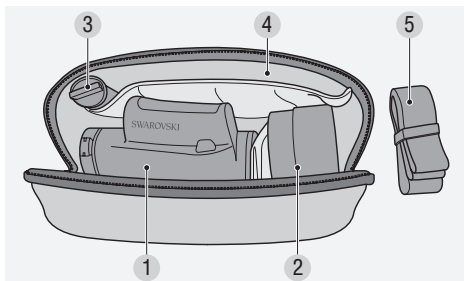

- | | |
|----------------------------|----------------------------|
| 1 Compartment for tM 35 | 4 Document compartment |
| 2 Compartment for tMA | 5 Field bag carrying strap |
| 3 Compartment for RB tM 35 | |

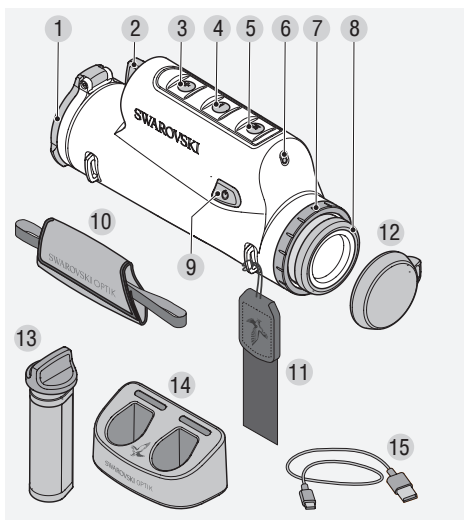

- | | |
|------------------------|----------------------------------|
| 1 Objective lens cover | 9 On/off button |
| 2 Battery compartment | 10 Hand strap |
| 3 Plus button | 11 Carrying strap |
| 4 Minus button | 12 Eyepiece cover |
| 5 Mode button | 13 RB tM 35 rechargeable battery |
| 6 Brightness sensor | 14 RBC battery charger |
| 7 Cover ring | 15 Micro-USB charger cable |
| 8 Eyepiece | |

Also supplied with: lens-cleaning cloth, field bag

2. PREPARING TO USE THE DEVICE

2.1 CHARGING THE BATTERY

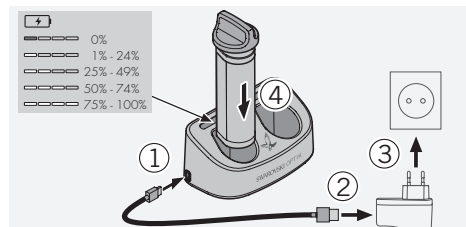

The tM 35 is supplied with the RB tM 35 rechargeable battery already installed. Please charge the battery fully before using the device for the first time (see 5.1).

The main adapter (3) is not supplied.

2.2 REMOVING THE BATTERY

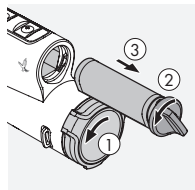

When removing the battery, you may need to turn the objective lens cover slightly to the side to ensure the hinge is not in the way (1). To protect the objective lens, the objective lens cover is built-in and cannot be removed.

Turning the cover allows you to change the position of the hinge and thus the opening direction. In order to remove the battery, the bayonet catch must be turned to the left (2).

The easy-grip bayonet catch for the battery is integrated in the battery housing. This allows you to easily grasp the bayonet catch, even when wearing gloves, and pull it to extract the battery (3).

2.3 INSTALLING THE BATTERY

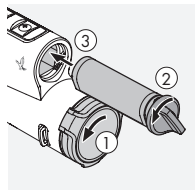

To make it easier to install the battery in the correct position even in absolute darkness, the lower side of the battery housing is flattened.

To insert the battery, rotate

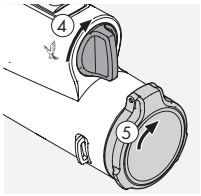

the catch counterclockwise by approximately 30° and push the battery in as far as it will go. Then rotate the bayonet catch clockwise by approximately 30° up to a vertical position (4). The battery is now secured.

The objective lens cover can then be returned to its original position.

2.4 ATTACHING THE HAND STRAP

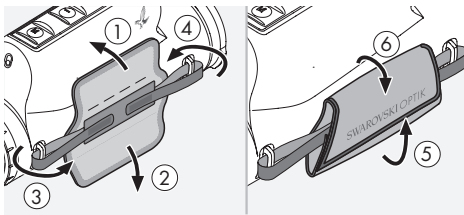

The carry strap, hand strap, eyepiece cover and winged eyecup supplied with the tM 35 need to be installed on the unit when needed.

The hand strap can be attached on either side of the tM 35 for left- or right-handed users. Once you have threaded both end pieces through the loop holders on the device, you can then adjust the length of the hand strap using the hook-and-loop fastener and fix it in place by folding over the leather strap.

2.5 ATTACHING THE CARRYING STRAP

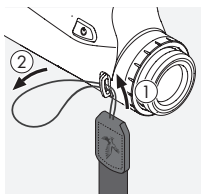

To attach the carrying strap to the tM 35, hold the side that does not have the click fastener and feed the loop through the loop holder on the eyepiece side, on the opposite side to the hand strap (1)+(2).

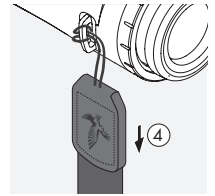
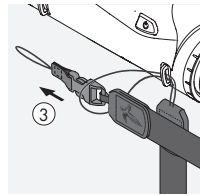

Then pull the other end of the carrying strap (3) through the loop and tighten it (4).

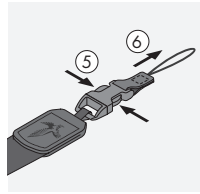

On the other side, release the end of the buckle (5) + (6) and feed the loop through the same loop holder (7).

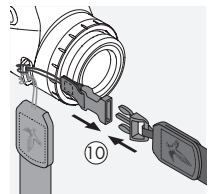
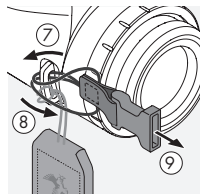

Then pull the end through the loop (8), tighten it (9), and attach the clip to the other end of the side carrying strap (10).



2.6 FITTING THE EYEPIECE COVER

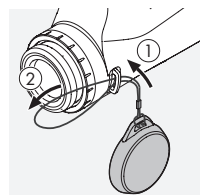

For the protection of the eyepiece during transportation

It is only possible to mount the eyepiece cover when no tMA adapter is mounted at the same time.

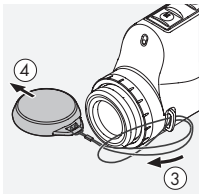

Feed the loop of the eye-piece cover through the loop holder on the same side of the iM 35 to which you attached the hand strap (strap attachment on eye-piece side ①+②).

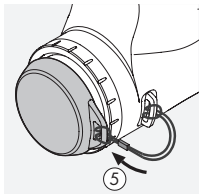

Then pass the cover through the loop ③ and tighten it ④. You can now use the cover to protect the eye-piece ⑤.

3. OPERATION

3.1 SWITCHING THE DEVICE ON

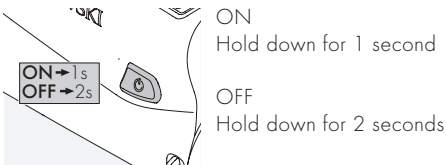

3.2 EXPLANATION OF SYMBOLS

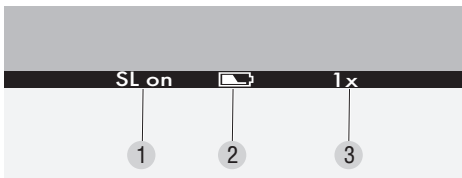

A menu bar is visible on the bottom edge of the display. This is automatically hidden after 5 seconds and appears again when the user presses a button or when activated by SWAROLIGHT.

- 1 SL on = SWAROLIGHT activated
SL off = SWAROLIGHT deactivated
- 2 Battery status with 5 levels
- 3 Magnification:
1x as a thermal imaging clip-on device

3.3 IMAGE CALIBRATION

The image is calibrated automatically after switching on, waking from sleep mode, or in the event of temperature changes. The image briefly freezes during this time. This is not an error.

3.4 SWITCHING FROM BLACK HOT/WHITE HOT

Briefly press the mode button (5) to change the setting. In Black Hot mode, objects with high thermal radiation appear darker than objects with lower thermal radiation. The image is reversed in White Hot mode.

3.5 SWAROLIGHT

The iM 35 has a tilt sensor.

For use as a thermal imaging clip-on device

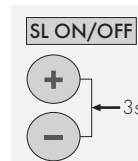
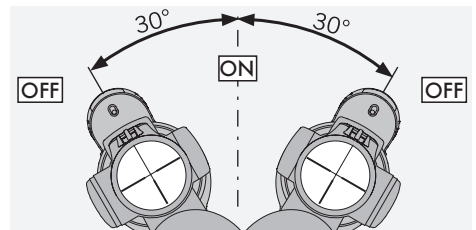
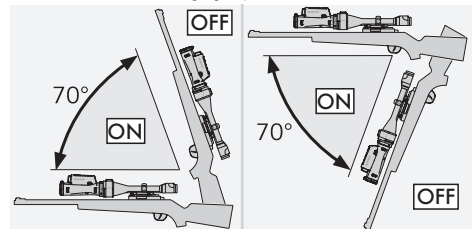

Pressing the plus (3) and minus (4) buttons simultaneously for 3 seconds switches this function either on or off. The tilt sensor detects whether the device is in a shooting position as a thermal imaging clip-on device.

The screen of the tM 35 switches off if the tilt angle is greater than 70° (upward or downward), for example, if you stand the rifle up vertically. The screen of the tM 35 also switches off if the lateral tilt is greater than 30°, for example, if you rest the rifle on your legs.

When you return the rifle to the shooting position, the screen of the tM 35 automatically switches on.

After one hour without operation, the device switches off completely.

3.6 AUTOMATIC BRIGHTNESS ADJUSTMENT

The tM 35 has an automatic brightness adjustment feature that automatically adapts the brightness of the display when the device is switched on or when activated by SWAROLIGHT. The tM 35 recognizes whether you are using the device during the day, in twilight, or at night. The brightness of the display can also be adjusted using the plus (3) or minus (4) buttons.

The display of the tM 35 has 32 brightness levels and can be dimmed very low at night to avoid dazzling. The tM 35 also has a memory function in the day, twilight, and night range. If your selected brightness level in one of the three ranges differs from the default setting, the tM 35 will save this custom brightness setting and apply it when the device is next activated or switched on.

4. FOR USE AS A THERMAL IMAGING CLIP-ON DEVICE

Your tM 35 has been developed specially for use as a thermal imaging clip-on device in combination with a SWAROVSKI OPTIK rifle scope and the SWAROVSKI OPTIK tMA thermal monocular adapter. When using this SWAROVSKI OPTIK complete system, we guarantee a maximum impact point deviation of 4 cm at 100 m/1.44 in at 100 yds (distance of the average impact point of two shot groups at 100 m/100 yds - with and without thermal imaging clip-on device).

4.1 ADJUSTING THE RIFLE SCOPE

In clip-on mode (1x magnification), the tM 35 is optimized for use in combination with a SWAROVSKI OPTIK rifle scope. In this case, only the central rectangular part of the display of the tM 35 is used (1x magnification). If required, you can select the magnification for your rifle scope using the magnification adjustment ring. In order to benefit from the entire field of view of the tM 35 (as a clip-on device) we recommend to use a rifle scope with a starting magnification of ≤ 3.5 .

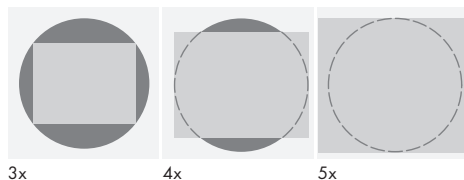

Note: When using the tM 35 as a handheld observation device to detect animals, you are still able to do that even when the tMA adapter is already mounted on the tM 35. As only the central part of the screen is used, the longer eye relief (due to the mounted tMA adapter) is not reducing the field of view.

5. USING THE BATTERY CHARGER

5.1 BATTERY STATUS INDICATOR

The 4 LED indicators on the charger light up for 30 seconds depending on the level of charging of the inserted battery.

- 1 LED = 0% - 24%
- 2 LEDs = 25% - 49%
- 3 LEDs = 50% - 74%
- 4 LEDs = 75% - 100%

Note: You can check the battery charge level by inserting the battery in the charger when the charger is not connected to an electric socket.

5.2 CHARGING THE BATTERY FOR THE FIRST TIME

For safety and transportation reasons, the battery is not supplied fully charged. Please charge the battery fully using the RBC battery charger supplied before using the device for the first time.

1. Connect the small micro-USB plug on the USB charging cable to the USB port on the charger.
2. Connect the large USB-A plug to a suitable USB power supply. (For optimum charging, at least 10 W output or at least 2.1 A).
3. Insert the battery in the charger.

5.3 CHARGING TIME

90 % battery level after 3.5 hours
100 % battery level after 5 hours

Note: The power supply used should have an output at least 2.1 A to allow two batteries to be charged simultaneously. In the case of lower output, charge each battery individually.

5.4 BATTERY CHARGER ERROR INDICATORS

1st LED flashing red for the 2nd inserted battery → Output current of the USB charging power supply is too low to charge two batteries simultaneously.

1st and 2nd LEDs flashing red → Battery temperature too low (< 0 °C/32 °F)

3rd and 4th LEDs flashing red → Battery temperature too high (> 45 °C/113 °F)

All 4 LEDs flashing red → Battery is faulty. Stop using the battery immediately.

All 8 LEDs are illuminated red → Charger is faulty. Stop using the charger immediately.

6. GENERAL INFORMATION

6.1 SERIAL NUMBER

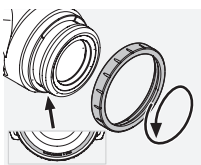

You can find the serial number of your product on the eyepiece. Unscrew the cover ring (7) in a counterclockwise direction to locate it.

6.2 ADDITIONAL INFORMATION



For more details and tips visit:
SWAROVSKIOPTIK.COM

7. CARE AND MAINTENANCE

7.1 LENS-CLEANING CLOTH

With the included microfiber lens-cleaning cloth you can clean even the most sensitive glass surfaces. It is ideal for objective lenses, eyepieces, and eyeglasses. Please keep the cloth clean, as dirt can damage the lens surface. Simply wash it in lukewarm soapy water and leave to air dry. Please only use it for cleaning glass surfaces.

7.2 CLEANING

We attach great importance to ensuring all elements and surfaces are very easy to clean.

Cleaning the optics. Maintain the outstanding performance of your tM 35 by keeping the glass surfaces free from dirt, oil, and grease. First brush off any larger particles of dirt using a lens brush. Then breathe gently on the lens and polish it with the lens-cleaning cloth to remove any remaining dirt. If it is very dirty (e.g. with sand), the twist-in eye-cup can be completely unscrewed, making it very easy to clean.

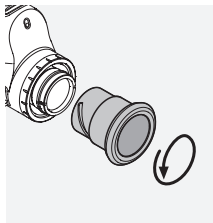

7.3 STORAGE

Keep your tM 35 in its bag in a well-ventilated place. If the tM 35 is wet, it must be dried first. In tropical areas or areas with high humidity, it is best to store it in an airtight container with a moisture-absorbing agent (e.g. silica gel).

8. COMPLIANCE

8.1 tM 35 COMPLIANCE

For more information on compliance, see:
http://swarovski.com/tM35_compliance

WEEE/ElektroG



This symbol indicates that this product must not be disposed of as household waste under the WEEE Directive (Waste Electrical and Electronic Equipment Directive) and national laws.

This product must be returned to a dedicated collection site. You can obtain information about collection sites for waste equipment from your local authorities or from an authorized site for the disposal of waste electrical and electronic equipment. Disposing of this product correctly helps to protect the environment and prevents potential damage to both the environment and human health which could occur if the products are not handled correctly.

8.2 RB tM 35 RECHARGEABLE BATTERY COMPLIANCE

For more information on compliance, see:
http://swarovski.com/tM35_compliance

WEEE/ElektroG



This symbol indicates that the battery must not be disposed of with household waste in accordance with the WEEE (Waste Electrical and Electronic Equipment) Directive and national or local laws. The battery must be disposed of at a designated collection point.

9. SAFETY RECOMMENDATIONS

9.1. GENERAL INSTRUCTIONS



Never look through the device while walking as you may overlook obstacles.

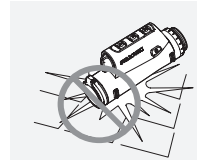

Protect your device against knocks.

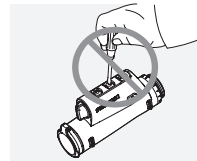

Repairs and servicing must only be carried out by SWAROVSKI OPTIK Absam (Austria) or SWAROVSKI OPTIK North America, otherwise your warranty will be void.

- Only SWAROVSKI OPTIK batteries should be used in the product. Use of any other battery may result in damage to the device.
- Check the position of the tMA thermal monocular adapter before firing a shot. If it is not fully engaged on the rifle scope, correct the position.
- The tM 35 is waterproof and dustproof and received the rating IP68 in a test under controlled laboratory conditions according to the IEC standard 60529.
- For safety reasons (battery), the tM 35 switches off automatically in temperatures below -15°C ($+5^{\circ}\text{F}$) or above $+50^{\circ}\text{C}$ ($+122^{\circ}\text{F}$).

WARNINGS FOR THE RB tM 35 RECHARGEABLE BATTERY

GENERAL INFORMATION FOR USE OF THE RBC BATTERY CHARGER IN THE UNITED STATES:

This product is validated according to UL62368-1. This product should be supplied by a ITE Listed Power Unit marked "Class 2" or LPS, with USB output rated 5V dc, min. 2100 mA."

This product is intended to charge the RB AFL batteries and the RB tM 35 batteries from SWAROVSKI OPTIK only.

WARNING!

Risk of fire and burns. Never open, damage, or heat the battery to above 80 °C (176 °F). Observe the safety information. Only the charger supplied by SWAROVSKI OPTIK should be used.



Possible risks:

- Risk of fire and explosion
- Risk of emission of toxic or corrosive substances
- Risk of burns

This product has a replaceable and rechargeable lithiumion battery. When using the product, please note the following:

- Do not continue to use the battery if the outer casing is damaged or if you suspect the battery is damaged. In this case, contact our customer service immediately as there is a risk of explosion and/or accident.
Clear warnings of a defective battery include, for example, deformations (bulges), melting of areas on the plastic casing, discoloration, odor, high heat generation.
- Do not use the battery incorrectly as this can lead to damage to the battery and an associated risk of fire and explosions.
 - Do not attempt to open the battery or take it apart.
 - Do not short-circuit the battery. Never store the battery in a hazardous location in a cardboard box or a drawer where the battery contacts could short-circuit each other or where they could be short-circuited by other conductive materials.

- Avoid mechanical stresses (pressure, deformations, impacts).
- Keep the battery dry and clean. If the battery becomes dirty, dry and clean the contacts using a clean, dry cloth.
- Do not use any electrically conductive materials for cleaning.
- If the battery leaks, make sure that the fluid does not come into contact with your skin or eyes, and do not inhale the fumes emitted. If this is the case, seek medical assistance.
- Do not expose products with batteries to excessive heat (e.g. direct sunlight, fire, or proximity to heat sources such as radiators or appliances that produce heat).

INFORMATION ON CHARGING THE LI-ION BATTERY

- Only charge the battery using the RBC battery charger supplied and a suitable power supply that complies with local regulations or has FCC/CE/IC approval.
- Using damaged cables or chargers or charging in humid environments may cause electric shocks, fire, injury, or damage to the equipment or other property.
- The optimum charging temperature is between 15 °C and 25 °C (59 °F and 77 °F) ambient temperature. The permitted charging temperature is between 0 °C and 37 °C (32 °F and 99 °F). Do not go below or exceed this temperature range during charging.
- Do not leave the battery unattended while it is charging.
- Do not leave the battery in the charger for longer than necessary.
- Make sure that the battery is not covered during charging.
- Pay particular attention to any unusual increase in temperature. The battery should not be hot to the touch during charging.

GENERAL INFORMATION AND STORAGE

- The battery life depends on the ambient temperature.

- Under no circumstances should batteries be stored for longer periods (days) in a discharged state as this can lead to irreparable damage. Charge the battery to 60 - 80% before storage. If the battery is stored at room temperature, it must be recharged after 6 months.
- The service life of a rechargeable battery is limited and its performance decreases with the duration of use. We advise not to exceed a service life of 5 years.

FAULTY BATTERIES

In the event of a faulty battery or deformed battery housing, under no circumstances should you return the device including the battery.

For safety reasons, faulty batteries must be disposed of at local hazardous goods collection points. In this case, remove the faulty battery from the device. If it is not possible to remove the battery, please contact our Customer Service team at customerservice@swarovski-optik.com.

In the event of any damage to the tM 35, please return the device without the battery.

Please note that international legislation on hazardous goods (IATA, ADR, etc.) applies to any shipment of lithium-ion cells (batteries).

WARRANTY

This product from SWAROVSKI OPTIK is a high-quality instrument for which we grant worldwide warranty and goodwill services. For more information, please visit:

http://swarovs.ki/tM35_warranty



All the specifications given are typical values.

We reserve the right to make changes regarding design and delivery.
We accept no liability for printing errors.