

Daisy Flush Mount

Assembly Instructions

URBAN OUTFITTERS

TOOLS REQUIRED BUT NOT INCLUDED:

Phillips head screw driver, Wire cutter, Electrical tape

WARNINGS:

Do not throw away packing materials and carton until after assembly.

Ensure all parts are present prior to assembly.

Contact customer service immediately if parts are missing.

Assemble all parts on a clean smooth surface.

Professional installation is recommended.

Use a TYPE A 60W MAX BULB DO NOT EXCEED SPECIFIED WATTAGE



CARE INSTRUCTIONS:

Avoid direct exposure to sunlight.

Do not place over heat or air conditioning vents.

Adjust levelers so that the furniture sits flat on uneven floors.

Blot spills do not rub, with a clean white cloth.

Do not use harsh chemicals.

Before cleaning any part test a small spot in a hidden area.

You may need to re-tighten all bolts after initial use.

PARTS INCLUDED:



(A) Screw
[0.29" DIA X 0.98" L]
x2



(B) Screw
[0.26" DIA X 0.79" L]
x2



(C) Plastic Wire Connector
x3

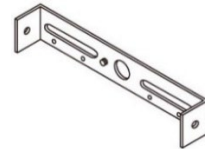

(D) Mounting Bracket

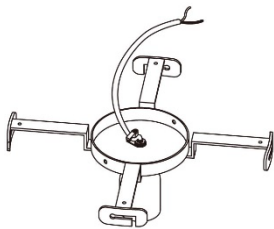

(E) Mounting Base

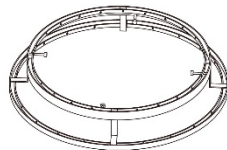

(F) Metal Frame

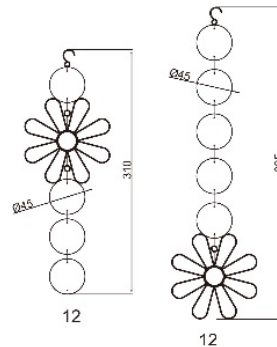

(G) Capiz Inside
x3

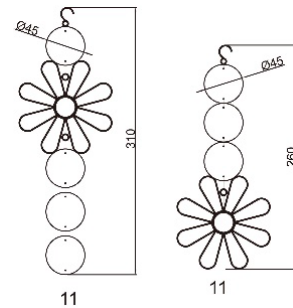

(H) Capiz Outside
x22

Daisy Flush Mount

Assembly Instructions

STEP 1

Ensure the power to the wire in the existing electrical box is shut off. Attach the Mounting Bracket (D) to the electrical box using the Screws (A) and tighten with a Phillips head screw driver (not included).

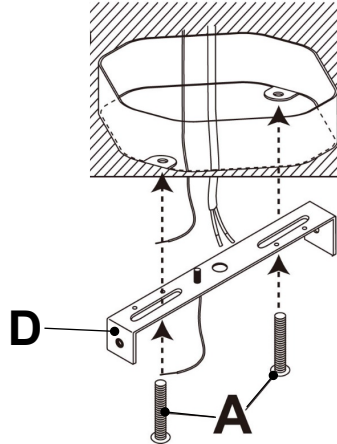

STEP 2

Attach the existing uncoated copper ground wire to the copper ground wire pre-attached to the Mounting bracket (D) with a Plastic wire connector (C). Then, wrap the connection with electrical tape (not included).

Next, verify the existing hot (usually black) and neutral wire (usually white). You may need to restore the power in order to verify.

The neutral wire of the Flush-mount fixture is indicated by a white line. Connect the existing neutral wire to the neutral wire of the Flush-mount fixture with a plastic wire connector (C). Then, wrap the connection with the electrical tape (not included). The hot wire of the Flush-mount fixture is transparent and without a white line. Connect the existing hot wire to the hot wire of the Flush-mount fixture with a plastic wire connector (C). Then, wrap the connections with the electrical tape (not included). Be sure no strands of wire are exposed for all connections. **Do not reverse the hot and neutral connections.**

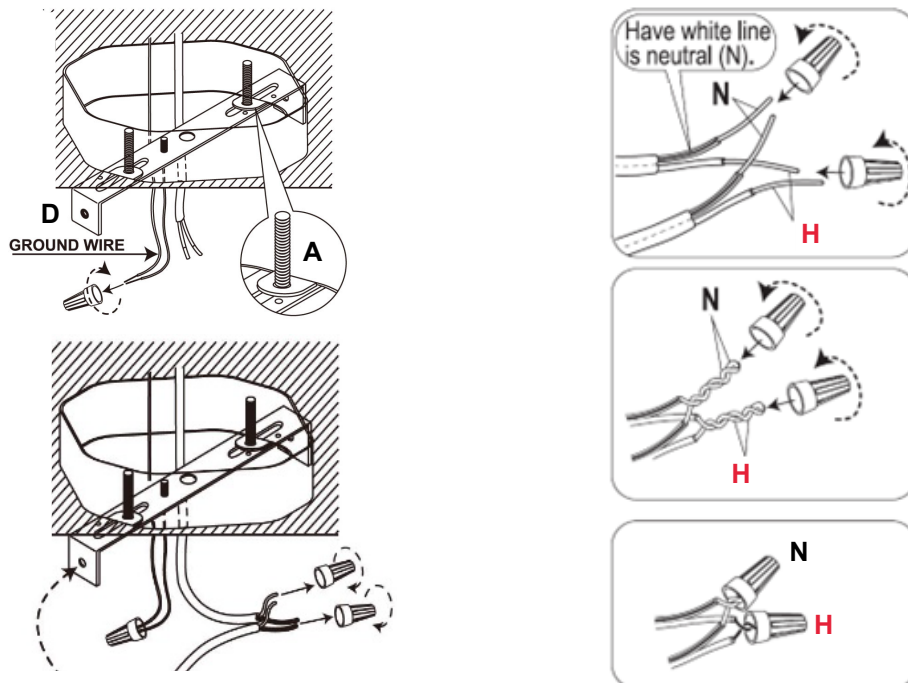

Daisy Flush Mount

Assembly Instructions

URBAN OUTFITTERS

STEP 3

Hang the Inside and Outside Capiz strands (G&H) on the Metal Frame (F) as shown.

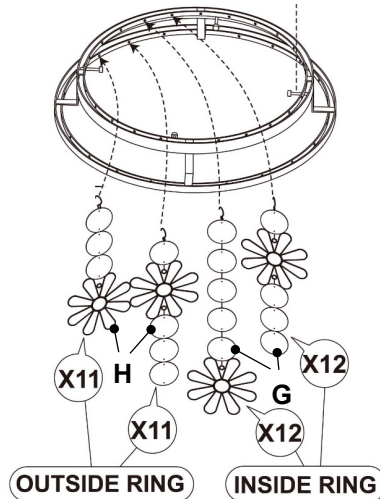

STEP 4

Place the Mounting Base (E) over the Mounting Bracket (D) as shown. Insert the Screws (B) as shown and tighten with a Phillips head screw driver (not included). Screw a Type A 60W bulb into the Mounting Base (E). Place the Metal Frame (F) into the Mounting Base (E) and gently turn clockwise to attach it to the Mounting Base (E). Restore power to the fixture to complete installation.

