

# Marina J Hook

**URBAN OUTFITTERS**

## Assembly Instructions

---

### TOOLS REQUIRED BUT NOT INCLUDED:

Drill, Phillips head screwdriver driver, Pencil, Level

### WARNINGS:

Do not throw away packing materials and carton until after assembly.

Ensure all parts are present prior to assembly.

Contact customer service immediately if parts are missing.

Assemble all parts on a clean smooth surface.

### CARE INSTRUCTIONS:

Avoid direct exposure to sunlight.

Do not place over heat or air conditioning vents.

Adjust levelers so that the furniture sits flat on uneven floors.

Blot spills with a clean white cloth, do not rub.

Do not use harsh chemicals.

Before cleaning any part test a small spot in a hidden area.

You may need to re-tighten all bolts after initial use.

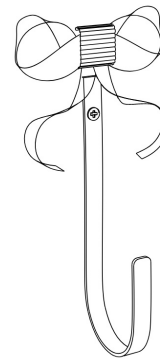

6" H x 3" W x 3" D

### PARTS INCLUDED:

---

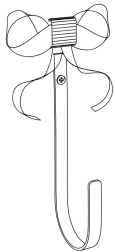

(A) J Hook



(B) Wall Anchor  
[16x7x35 mm] x1

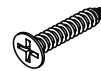

(C) Machine Screw  
[8x8x32 mm] x1

### STEP 1

Place the Hook (A) on the wall in a desired location and ensure it is level.

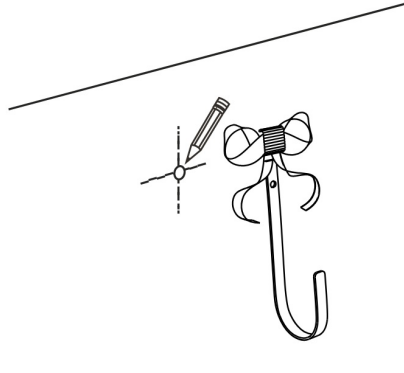

### STEP 2

Wood or Stud installation:

Use a Phillips head screwdriver to fasten the Hook (A) directly to the wall using the screws (C) and a Phillips head screwdriver (not included).

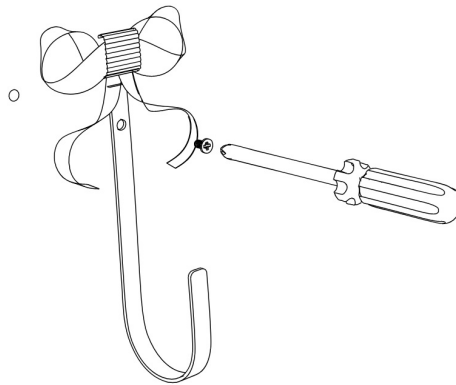

Drywall installation:

Mark the location of the screw holes in the Hook (A) on the wall. Insert anchors (B) into the wall at the marked locations using a drill and a hammer (not included). Insert screws (C) into the anchors, then tighten with a Phillips head screwdriver (not included).

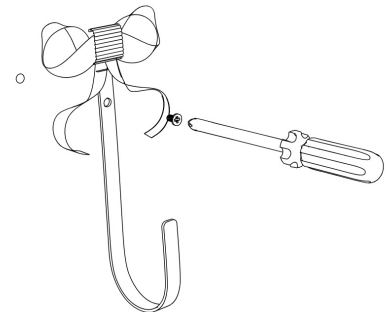
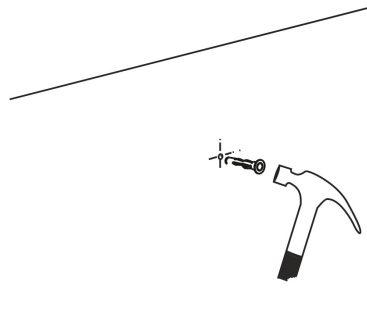
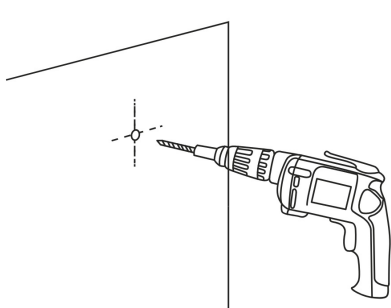

**The included hardware is intended for attachment to drywall or wooden wall surfaces, contact your local hardware store to find the correct anchor for alternative wall-types such as stone or brick.**