

Harper Multi Shelf

Assembly Instructions

URBAN OUTFITTERS

TOOLS REQUIRED BUT NOT INCLUDED:

Phillips head screwdriver, Hammer, Pencil

WARNINGS:

Do not throw away packing materials and carton until after assembly.
Ensure all parts are present prior to assembly.
Contact customer service immediately if parts are missing.
Assemble all parts on a clean smooth surface.

CARE INSTRUCTIONS:

Avoid direct exposure to sunlight.
Do not place over heat or air conditioning vents.
Adjust levelers so that the furniture sits flat on uneven floors.
Blot spills with a clean white cloth, do not rub.
Do not use harsh chemicals.
Before cleaning any part test a small spot in a hidden area.
You may need to re-tighten all bolts after initial use.

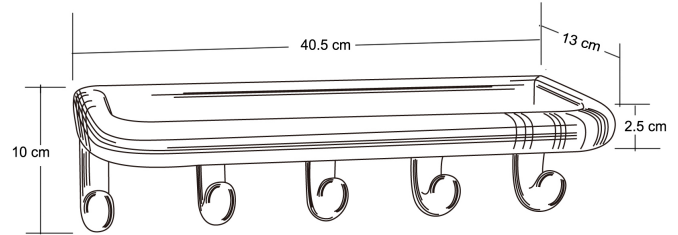

PARTS INCLUDED:

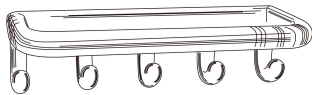

(A) Shelf
[15.9" x 5.11" x 3.93"]
or
[40.5 x 13 x 10 cm]



(B) Plastic Anchor
[D0.35" x 1.38"] x2
or
[D9 x 35 mm] x2



(C) Screw
[D0.27" x 1.38"] x2
or
[D7 x 35 mm] x2

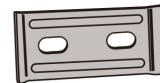

(D) Metal Hardware
[D2.08" x 0.86"] x2
or
[L53 x W22 mm] x2

Harper Multi Shelf

Assembly Instructions

URBAN OUTFITTERS

STEP 1

Place the Shelf (A) on the wall in its desired location. Ensure the Shelf (A) is level and mark the location for the metal hardware (D) using the dimensions in the below diagram as reference.

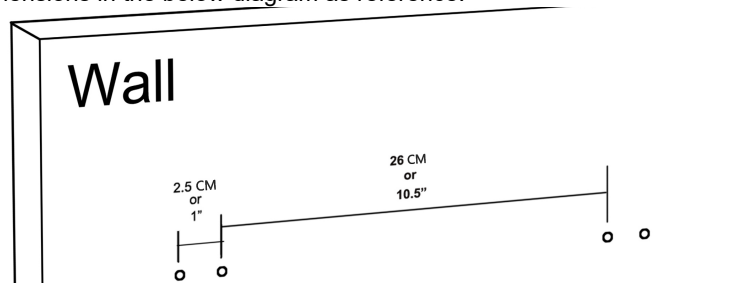

STEP 2

Wood or Stud installation:

Insert the screws (C) through the metal hardware (D) then, use a Phillips head screwdriver to fasten the metal hardware (D) tightly to the wall. Ensure the metal hardware is aligned and level.

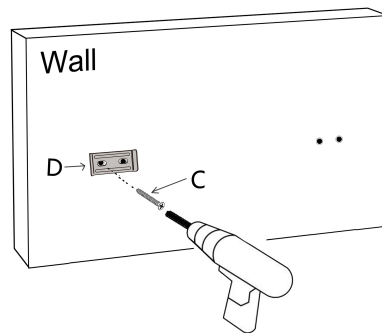

Drywall installation:

Insert anchors (B) into the wall at the marked locations using a drill and a hammer (not included). Insert the screws (C) through the metal hardware (D) and into the anchors (B) then, use a Phillips head screwdriver to fasten the metal hardware (D) tightly to the wall. Ensure the metal hardware is aligned and level.

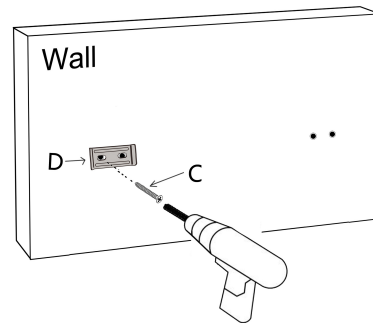
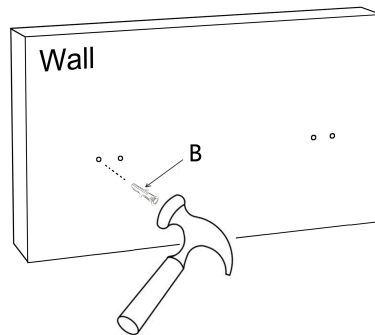
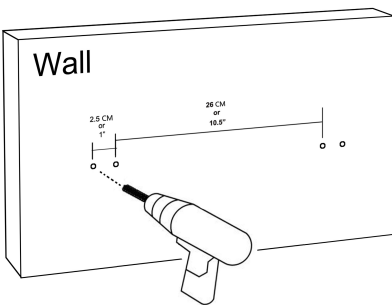

The included hardware is intended for attachment to drywall or wooden wall surfaces, contact your local hardware store to find the correct anchor for alternative wall-types such as stone or brick.

STEP 3

Hang the shelf (A) gently on the metal hardware (D). If the shelf (A) slopes downward, tighten the screws (C).

