

# CAM BOOKSHELF

URBAN OUTFITTERS

## Assembly Instructions

### TOOLS REQUIRED BUT NOT INCLUDED

Drill, Phillips head screwdriver, Hammer, Pencil

### WARNINGS:

At least two people recommended for assembly  
 Do not throw away packing materials and carton until after assembly.  
 Ensure all parts are present prior to assembly.  
 Contact customer service immediately if parts are missing.  
 Assemble all parts on a clean smooth surface.  
**Attach furniture to the wall to prevent tipping - that can cause damage and/or bodily injury.**

### CARE INSTRUCTIONS:

Avoid direct exposure to sunlight.  
 Blot spills with a clean, white cloth; do not rub.  
 Do not use harsh chemicals.  
 Before cleaning any part, test a small spot in a hidden area.  
 Do not place over heat or air conditioning vents.  
 Do not over-tighten the parts.  
 The parts may loosen after initial use; re-tighten as necessary.

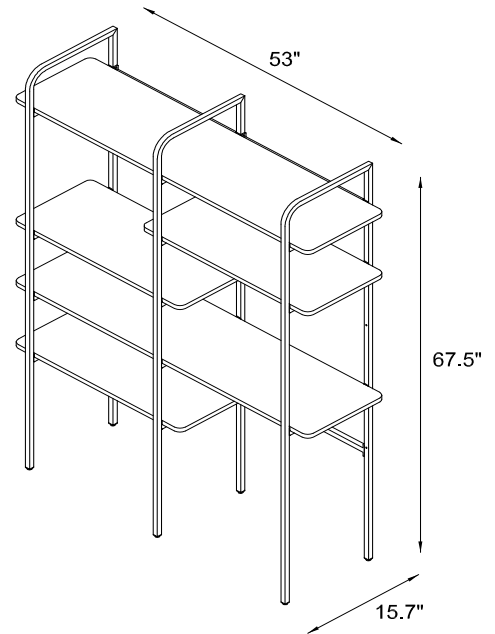

## PARTS INCLUDED

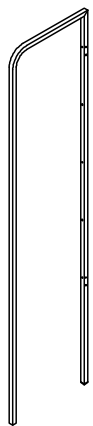

A) Left Frame

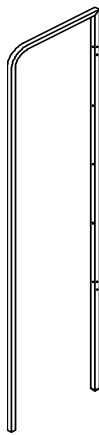

B) Center Frame

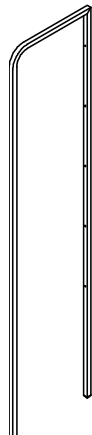

C) Right Frame

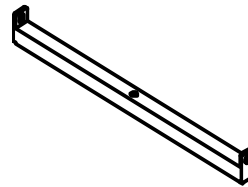

D) Short Rail x 12

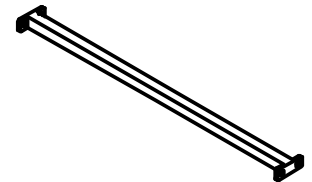

E) Long Rail x 4

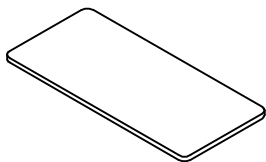

F) Short Wood Shelf x 3

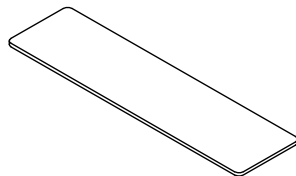

G) Long Wood Shelf x 2



H) Bolt [M6x10mm] x40



I) Adjustable Leveler x 6

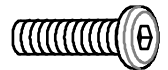

J) Bolt [M6x32mm] x12



K) Wall screw [4x32] x4



L) Drywall Anchor x4

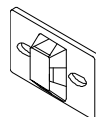

M) Anti-tip bracket x 2



N) Nylon Strap x 2



O) Allen Key

## Assembly Instructions

### STEP 1

Lay down all the parts onto a clean carpet or cardboard for assembly. One at a time, align short rail (D) with Left, Center, Right frame (A) (B) (C), as shown. Insert bolts (H) and partially tighten with Allen key (O). Once all bolts are inserted and partially tightened, fully tighten the bolts.

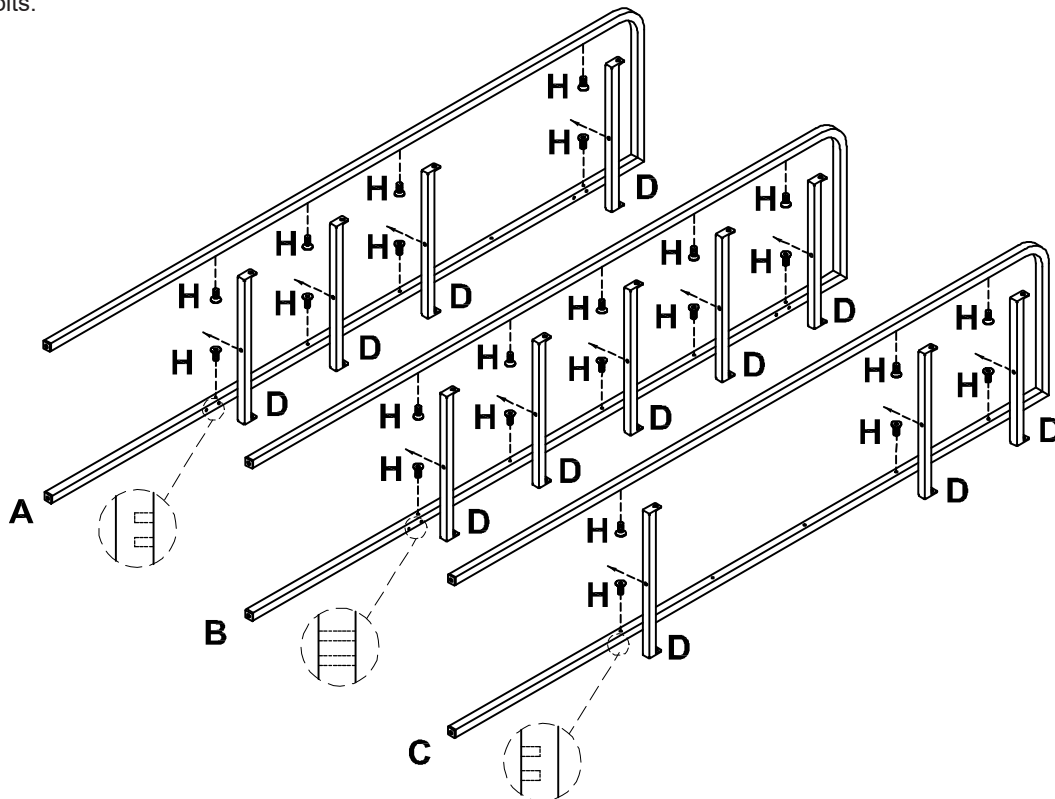

### STEP 2

Align long rail (E) with partially assembled frame as shown. Insert bolts (H) and partially tighten with Allen key (O). Once all bolts are inserted and partially tightened, fully tighten the bolts. Screw adjustable levelers (I) into the bottom of the frame.

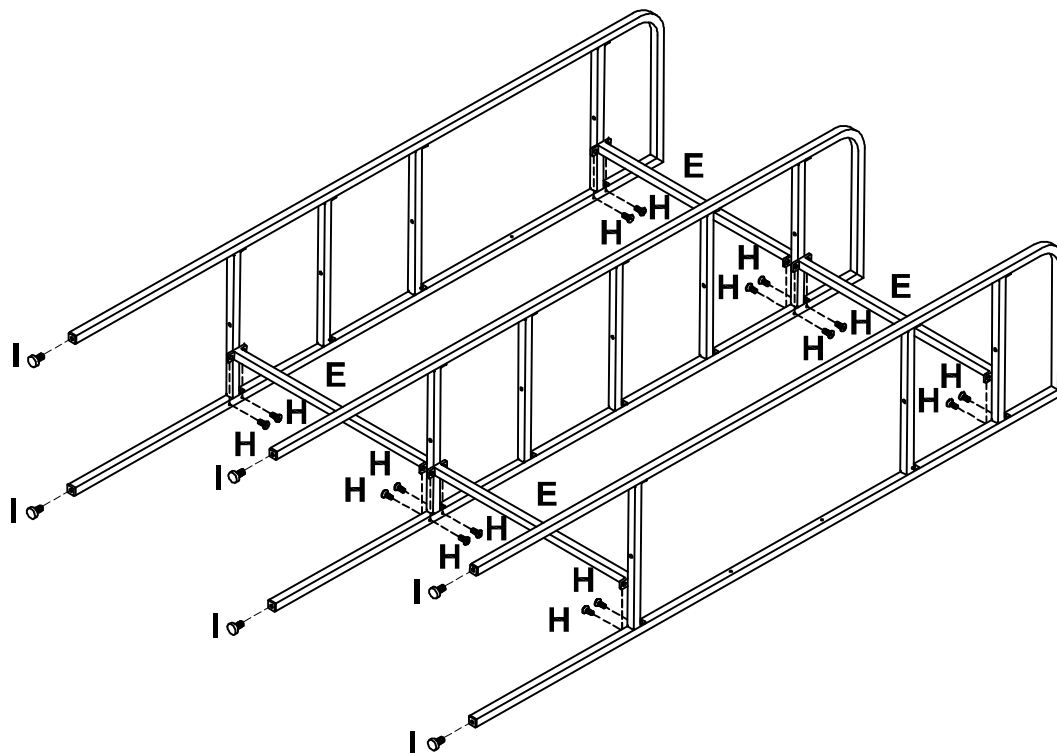

## Assembly Instructions

### STEP 3

One at a time, insert short and long shelf (F),(G) on partially assembled frame. Insert bolt (J), and partially tighten with Allen key (O). With help, flip the shelf upright.

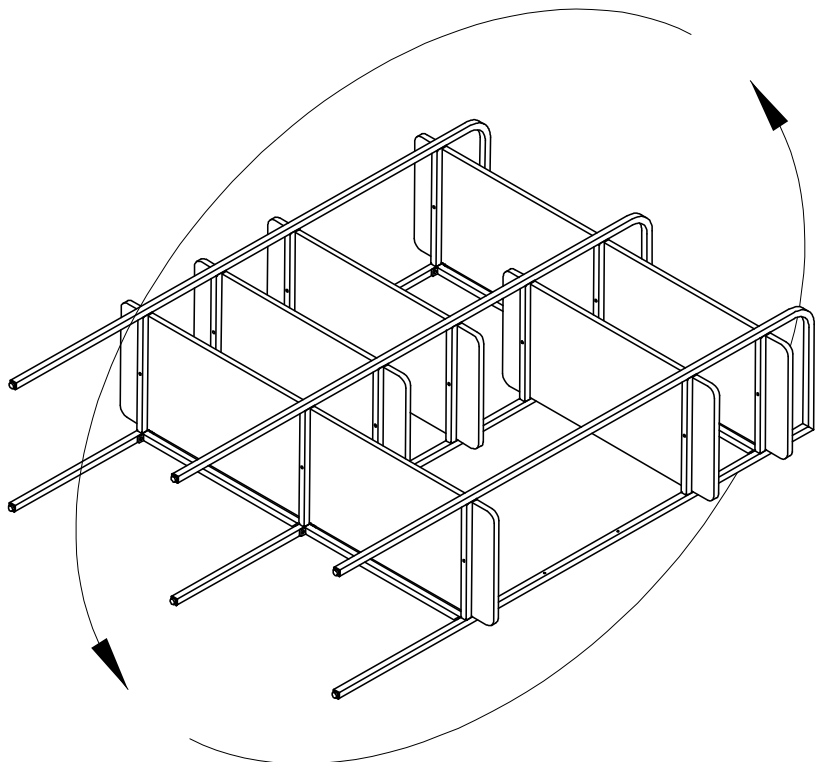
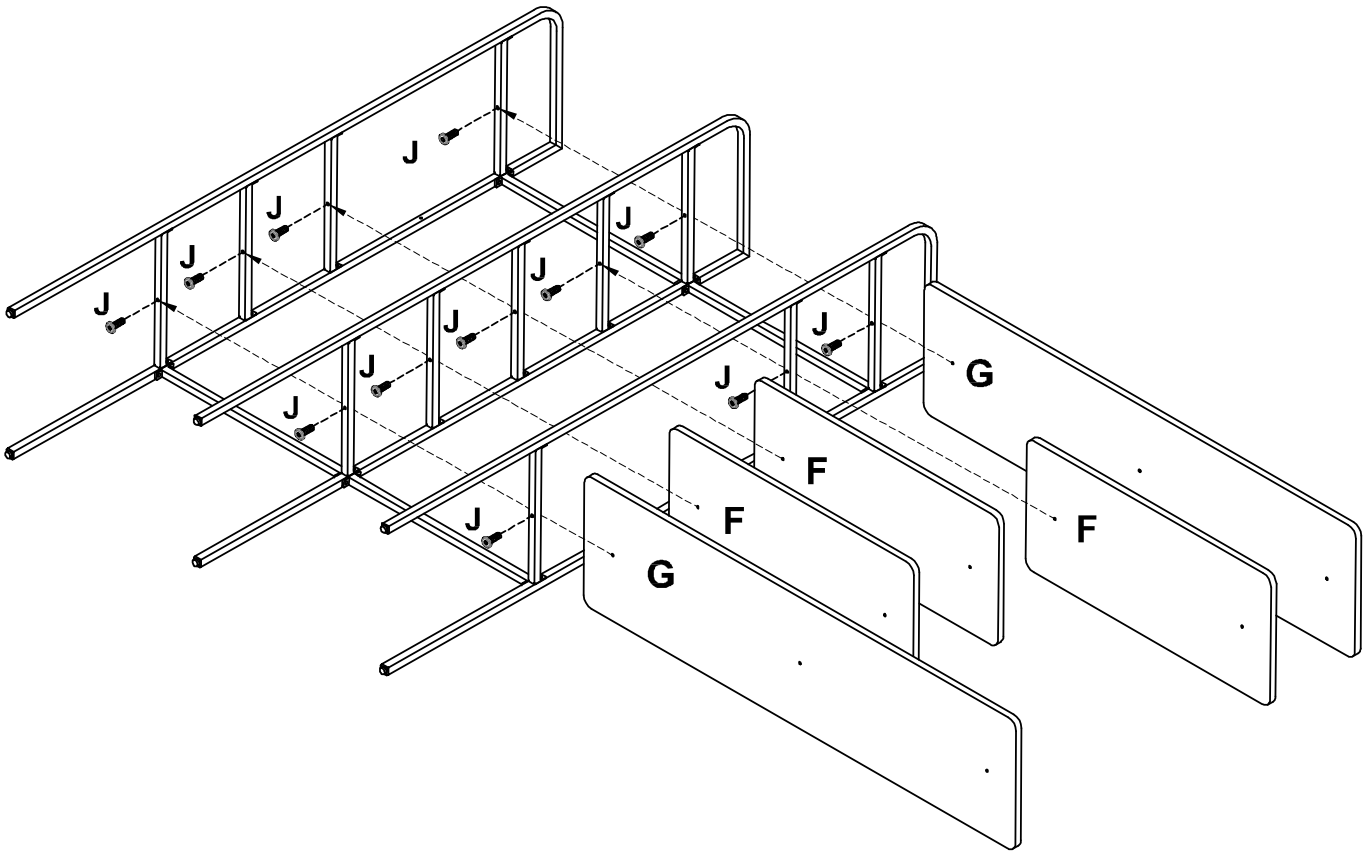

## Assembly Instructions

### STEP 4

Place the shelf against the wall in a chosen location. Place the anti-tip bracket (M) against the wall beside the outside leg of the furniture in the area circled on the graphic below. Mark the location of the holes in the bracket (M) on the wall then, with help, move the furniture aside.

#### Stud installation:

One at a time, place the bracket (M) against the wall at the marked locations. Insert the screws (K) through the anti-tip brackets (M) and use a Phillips head screwdriver or drill to fasten the screws (K) directly into the wall.

#### Drywall installation:

One at a time insert anchors (L) into the wall at the marked locations using a hammer and a drill. Place the anti-tip bracket (M) over the anchors (L). Insert screws (K) through the anti-tip bracket (M) into the anchors (L) then, tighten with a Phillips head screwdriver or drill.

### STEP 5

Insert the nylon strap (N) through the hole in the anti-tip bracket (M) and around the leg of the furniture. Insert the end of the nylon strap (N) through the hole at its top and pull tight to secure the furniture.

**The included hardware is intended for attachment to drywall or wooden wall surfaces. Contact your local hardware store to find the correct anchor for alternative wall types such as stone or brick.**

