

MATTHEW CHAIR

URBAN OUTFITTERS

Assembly Instructions

TOOLS REQUIRED BUT NOT INCLUDED: NONE

WARNINGS:

At least two people recommended for assembly.
Do not throw away packing materials and carton until after assembly.
Ensure all parts are present prior to assembly.
Contact customer service immediately if parts are missing.
Assemble all parts on a clean smooth surface.

CARE INSTRUCTIONS:

Avoid direct exposure to sunlight.
Do not place over heat or air conditioning vents.
Adjust levelers so that the furniture sits flat on uneven floors.
Blot spills with a clean white cloth, do not rub.
Do not use harsh chemicals.
Before cleaning any part test a small spot in a hidden area.
You may need to re-tighten all bolts after initial use.

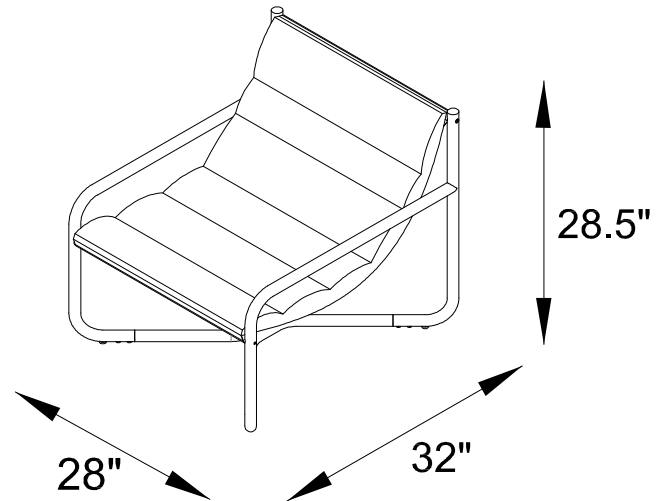

PARTS INCLUDED

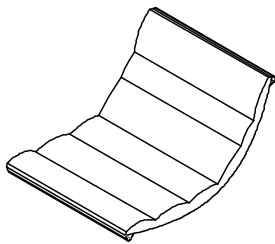

A) Upholstery

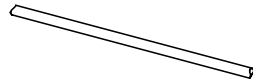

B) Cross Rail
x2

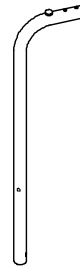

C-R) Metal Right Frame



C-L) Metal Left Frame

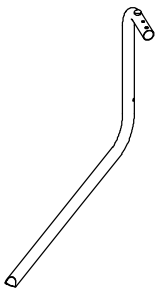

D-R) Metal Right Arm Frame

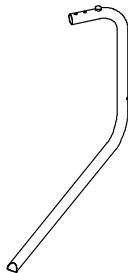

D-L) Metal Left Arm Frame

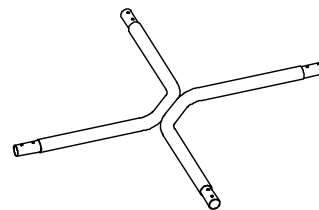

E) Metal Base

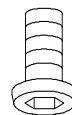

F) Bolt
[M6x10mm] x8

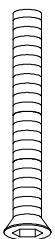

G) Bolt
[M6x50mm] x6



H) Allen Key

STEP 1

Lay down all the parts on a clean carpet or cardboard for assembly. Align metal base (E) with metal arm frame (D-R) (D-L). Insert bolt (F) and partially tighten with Allen key (H). Align metal arm frame (D-R) (D-L) with metal frame (C-R) (C-L) as shown. Insert bolt (G) and partially tighten with Allen key (H). Once all bolts are inserted and partially tightened, fully tighten the bolts. Carefully flip the chair upright.

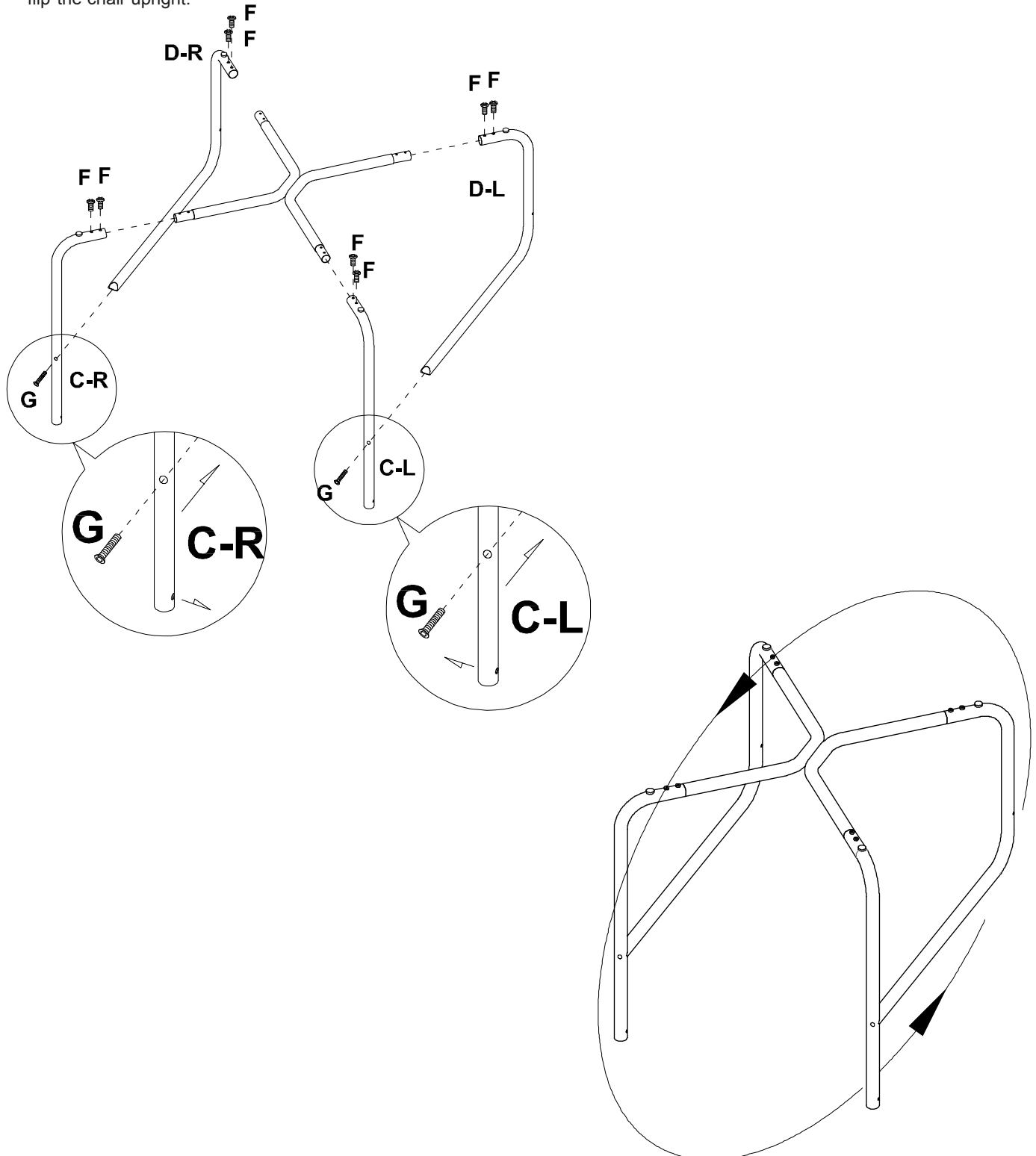

STEP 2

Insert cross rail (B) into the sleeves in upholstery (A) as shown. Place the upholstery and cross rails in the center of the partially assembled frame as shown. Insert bolt (G) and partially tighten with Allen key (H). Once all bolts are inserted and partially tightened, fully tighten the bolts.

