

## » The Linear System

English  
1/2018

 **MayTec<sup>®</sup>**

Eco-Slide complete	4.001
Linear units complete	4.101
Linear shaft guidance complete	4.119

Catalogue in preparation:

Carriage unit	4.121
Drive unit	4.131
Turning unit without shaft end	4.141
Turning unit with shaft end	4.151
Motor flange	4.161
Synchronising unit	4.171
Gearbox unit	4.181

Article number group	Page
4.000 The MayTec Linear System.....	2
<b>4.000 Eco-Slide.....</b>	<b>3</b>
4.000 Numerical key for articles (Eco-Slide) .....	3
4.001 Eco-Slide complete, with toothed belt drive with guide shaft .....	4
4.001 Selection table for Eco-Slide complete .....	6
<b>4.100 Linear units.....</b>	<b>7</b>
4.100 Numerical key for articles (Linear unit) .....	7
4.101 Linear units complete, with toothed belt drive	
4.101 with wheel guide .....	8
4.101 with ball bearing guide.....	10
4.101 Design of the linear system .....	12
4.101 Selection table for linear units.....	16
4.101 Shaft guidance horizontal.....	16
4.101 Shaft guidance vertical .....	20
<b>4.119 Linear shaft guidance complete .....</b>	<b>22</b>
4.119 Construction form.....	22
4.119 Numerical key for articles .....	23
4.119 Linear shaft guidance, single sided .....	24
4.119 Linear shaft guidance, double sided.....	33
4.119 Shaft guidance profiles .....	38
4.119 for shaft-Ø12 .....	38
4.119 for shaft-Ø16 .....	39
4.119 for shaft-Ø20 .....	40
4.119 for shaft-Ø25 .....	41
4.119 Shafts .....	42
4.119 Machining of shafts .....	43
4.119 Order example for shafts .....	44

## Solutions with Innovative Profile

### The Linear System

The MayTec linear guidance system offers the seamless integration of components from all well known bearing manufacturers onto the MayTec profile system.

Along with the integration of these components, MayTec also offers a huge range of accessories to expand and simplify the integration of linear guidance technology with profile technology.

The integration of various linear guidance hardware is also possible due to the modular concept of the system.

Economical and functional solutions can now be realised with a minimum of time and effort.

### Performance

Due to the modularity of the MayTec linear system and profiles, you can choose any of the following:

- Delivery of the individual components ex factory
- Delivery of cut and prepared profiles, shafts and components according to parts list for customer's assembly
- Delivery of pre-fitted modular units
- Delivery of complete systems
- Assembly on site

### Application

Due to the flexible and modular design, the MayTec profile system is extremely easy to use and fast to assemble. The system is also very easy to modify if necessary and components can be reused at any time.

An expert team is ready to support you with the use of the MayTec profile system and with your specific project requirements. Your chosen configuration depends only on the dimensions, expected forces and the required stability.

### Guide shaft Eco-Slide

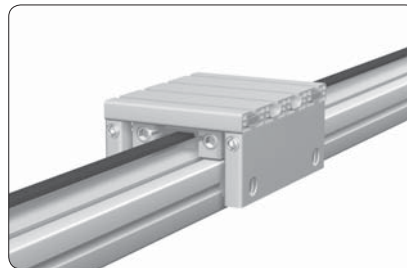

Sliding carriage in variable, easy and robust design with good sliding characteristics.

Width and height adjustable free from backlash.

### Encased roller bearings

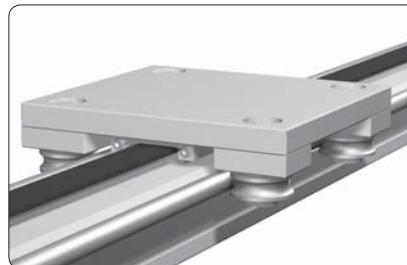

A tried and tested linear guidance system with a large range of application possibilities.

Depending on the required specifications and accuracy, encased roller bearings can be used for low or high load applications.

- Suitable for rough or dirty applications
- High force tolerance with low wear
- High accuracy with low friction
- Long life expectancy

### Shaft guidance

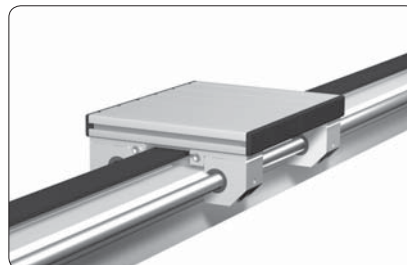

A proven and extremely flexible guidance system due to the compact nature of the construction.

Depending on the application requirements, either sliding or ball bearing guides can be used.

Shaft guide systems are used where high accuracy along with carriage stability is required.

- Compact form
- Low resistance
- High stability
- High accuracy
- Quiet rolling noise level

Challenge us !

Linear unit complete

4.0□□.□□□□□□.□□□□□.  
 4.0□□.□□□□□□.□□□□□.  
 4.0□□.□□□□□□.□□□□□.  
 4.0□□.□□□□□□.□□□□□.  
 4.0□□.□□□□□□.□□□□□.

**Key (line 1)**

Subassembly <sup>1)</sup>

Drive <sup>2)</sup>

Profile

- size
- orientation <sup>3)</sup>

□□.□□□□.□□□□  
 □□.□□□□.□□□□  
 □□.□□□□.□□□□  
 □□.□□□□.□□□□  
 □□.□□□□.□□□□  
 □□.□□□□.□□□□  
 □□.□□□□.□□□□  
 □□.□□□□.□□□□  
 □□.□□□□.□□□□  
 □□.□□□□.□□□□

**Key (line 2)**

Carriage

Belt

Turning unit

- base plate <sup>4)</sup>
- type <sup>5)</sup>
- type <sup>6)</sup>
- material <sup>7)</sup>
- width
- motor <sup>8)</sup>
- shaft end - left <sup>9)</sup>
- right <sup>9)</sup>

- <sup>1)</sup> 0 = Eco-Slide complete  
 1 = linear guidance profile  
 2 = carriage unit  
 3 = drive unit  
 4 = turning unit without shaft end  
 5 = turning unit with shaft end  
 6 = motor flange  
 7 = synchronising unit  
 8 = gearbox unit

- <sup>2)</sup> 0 = without drive  
 1 = toothed belt  
 2 = chain  
 3 = threaded spindle  
 4 = toothed rack  
 9 = multiple

- <sup>3)</sup> H = horizontal  
 N = neutral  
 V = vertical

- <sup>4)</sup> 1 = alu plate  
 2 = profile  
 3 = profile frame

- <sup>5)</sup> 1 = ST-connector  
 2 = screw-type connector

- <sup>6)</sup> A = HTD5M  
 B = HTD8M

- <sup>7)</sup> G = fiber glass  
 S = steel

- <sup>8)</sup> 1 = for motor with hollow shaft  
 2 = for motor with shaft  
 3 = for motor with base

- <sup>9)</sup> 0 = without  
 1 = left  
 2 = right  
 3 = double sided

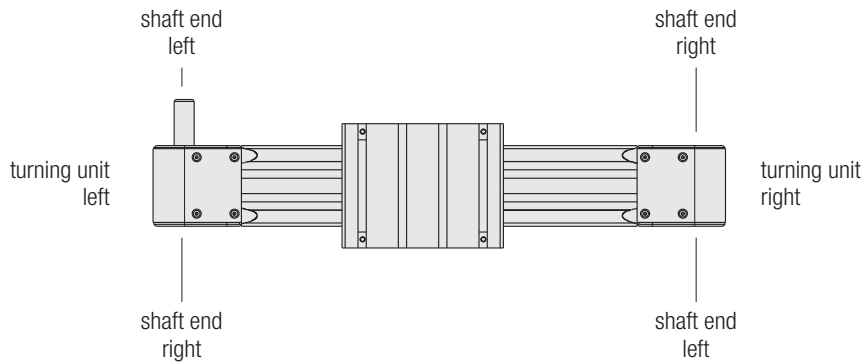

additional required order information:

- lift

**Eco-Slide**

- with toothed belt drive
- with guide shaft

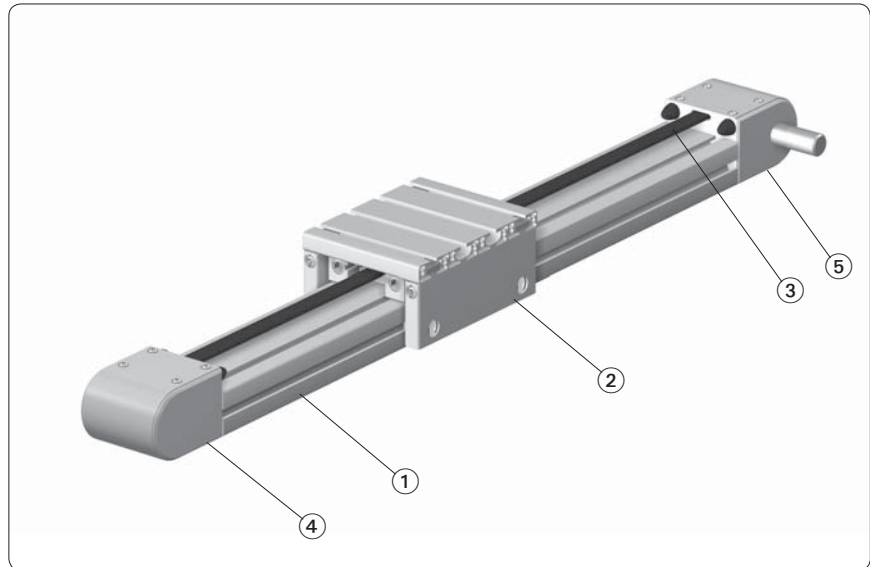

**Component groups of Eco-Slide**
**Ordering description:**

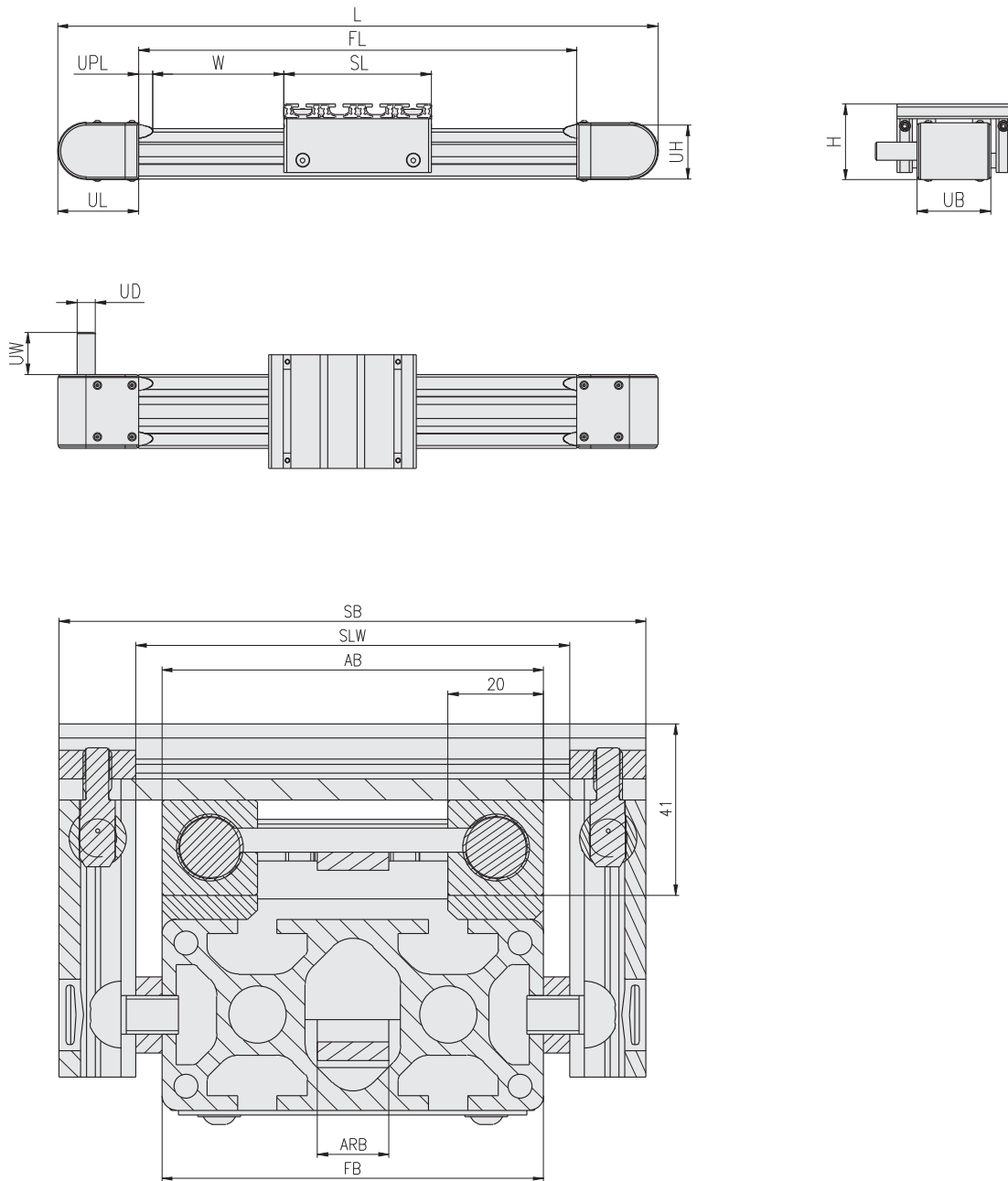
Article-No.	Description	
4.101...	Eco-Slide complete including:	
① 4.119...	Linear guidance profile	
② 4.121...	Carriage unit	<i>(catalogue in preparation)</i>
③ 4.131...	Drive unit	<i>(catalogue in preparation)</i>
④ 4.141...	Turning unit without shaft end	<i>(catalogue in preparation)</i>
⑤ 4.151...	Turning unit with shaft end	<i>(catalogue in preparation)</i>
⑥ 4.161...	Motor flange	<i>(catalogue in preparation)</i>
⑦ 4.171...	Synchronising unit	<i>(catalogue in preparation)</i>
⑧ 4.181...	Gearbox unit	<i>(catalogue in preparation)</i>

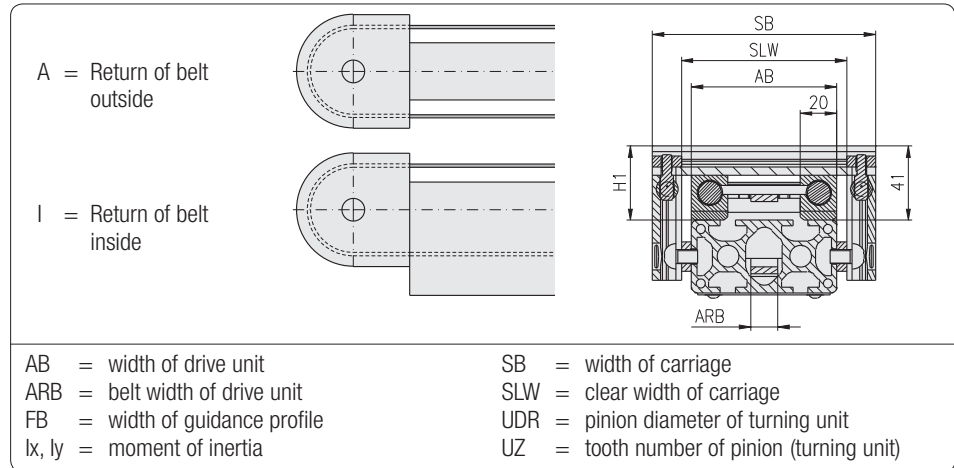

- AB = width of drive unit
- ARB = belt width of drive unit
- FB = width of guidance profile
- FL = length of guidance profile
- H = total height
- L = total length
- SB = width of carriage
- SL = length of carriage
- SLW = clear width of carriage
- UB = width of turning unit
- UD = shaft end diameter of turning unit
- UDR = pinion diameter of turning unit
- UH = height of turning unit
- UL = length of turning unit
- UPL = parabolic spring length of turning unit
- UW = shaft end length of turning unit
- W = lift

**Eco-Slide complete  
with toothed belt drive**

Eco-Slide complete		Linear guidance profile			Turning unit						Carriage				
Design	Article-No.	Profile	Technical data		Type	Belt 5M15		Type	Belt 5M25		Return of belt ARB		SLW	AB	SB
		Dim.	lx	ly		UZ	UDR		UZ	UDR	15	25			
	4.001.030060.65PH...	30×60	7	25	100	36	56.2	100	36	56.2	A	A	71	60	103
	4.001.030100.84PH...	30×100	12	115	100	36	56.2	100	36	56.2	A	A	111	100	143
	4.001.030150.85PH...	30×150	16	340	100	36	56.2	100	36	56.2	A	A	161	150	193
	4.001.040080.64PH...	40×80	24	82	60	28	43.4	100	40	62.5	I	A	91	80	123
	4.001.040120.84LH	40×120	26	194	100	40	62.5	100	40	62.5	A	A	131	120	163
	4.001.040160.104LH	40×160	37	478	60	28	43.4	100	40	62.5	I	A	171	160	203
	4.001.045090.64PH	45×90	34	126	60	28	43.4	100	44	68.9	I	A	101	90	133

Torque load			
	Article-No.	Dim.	M [Nm]
	4.001.030060.65PH...	30×60	17
	4.001.030100.84PH...	30×100	27
	4.001.030150.85PH...	30×150	39
	4.001.040080.64PH...	40×80	22
	4.001.040120.84LH	40×120	32
	4.001.040160.104LH	40×160	42
	4.001.045090.64PH	45×90	24



Linear unit complete

4.1□□.□□□□□□.□□□□□□.

4.1□□.□□□□□□.□□□□□□.  
 4.1□□.□□□□□□.□□□□□□.  
 4.1□□.□□□□□□ □□□□□□.  
 4.1□□.□□□□□□.□□□□□□.  
 4.1□□.□□□□□□.□□□□□□.

Key (line 1)

- Subassembly <sup>1)</sup>
- Drive <sup>2)</sup>
- Profile
  - size
  - orientation <sup>3)</sup>
- Shaft
  - orientation <sup>4)</sup>

□□.□□.□□□□□□□□□□□□  
 □□.□□.□□□□□□□□□□□□  
 □□.□□.□□□□□□□□□□□□  
 □□.□□.□□□□□□□□□□□□  
 □□.□□.□□□□□□□□□□□□  
 □□.□□.□□□□□□□□□□□□  
 □□.□□.□□□□□□□□□□□□  
 □□.□□.□□□□□□□□□□□□  
 □□.□□.□□□□□□□□□□□□  
 □□.□□.□□□□□□□□□□□□  
 □□.□□.□□□□□□□□□□□□  
 □□.□□.□□□□□□□□□□□□  
 □□.□□.□□□□□□□□□□□□  
 □□.□□.□□□□□□□□□□□□  
 □□.□□.□□□□□□□□□□□□  
 □□.□□.□□□□□□□□□□□□  
 □□.□□.□□□□□□□□□□□□  
 □□.□□.□□□□□□□□□□□□

Key (line 2)

- Shaft
  - number <sup>5)</sup>
  - assembly <sup>6)</sup>
  - Ø
- Carriage
  - material <sup>7)</sup>
  - base plate <sup>8)</sup>
  - bearing
    - roller <sup>9)</sup>
    - bush <sup>10)</sup>
- Belt
  - type <sup>11)</sup>
  - material <sup>12)</sup>
- Turning unit
  - width
  - motor <sup>13)</sup>
  - shaft end
    - left <sup>14)</sup>
    - right <sup>14)</sup>

- <sup>1)</sup> 0 = linear unit complete  
 1 = linear guidance  
 2 = carriage unit  
 3 = drive unit  
 4 = turning unit without shaft end  
 5 = turning unit with shaft end  
 6 = motor flange  
 7 = synchronising unit  
 8 = gearbox unit
- <sup>2)</sup> 0 = without drive  
 1 = toothed belt  
 2 = chain  
 3 = threaded spindle  
 4 = toothed rack  
 9 = multiple
- <sup>3)</sup> H = horizontal  
 N = neutral  
 V = vertical

- <sup>4)</sup> H = horizontal  
 V = vertical
- <sup>5)</sup> 1 = single sided  
 2 = double sided
- <sup>6)</sup> 2 = with guide profile
- <sup>7)</sup> shaft mounting elements
  - 1 = coated steel steel, galvanised
  - 2 = X46Cr13 steel, galvanised
  - 3 = X46Cr13 VA
- <sup>8)</sup> 1 = alu plate  
 2 = profile  
 3 = profile frame
- <sup>9)</sup> 11 = 2×fixed / 2×eccentric, adjustable topside  
 12 = 2×fixed / 2×eccentric, adjustable underside  
 15 = 4×eccentric, adjustable topside  
 16 = 4×eccentric, adjustable underside

- <sup>10)</sup> 21 = ball  
 25 = slide; synthetic  
 28 = slide; ceramics
- <sup>11)</sup> A = HTD5M  
 B = HTD8M
- <sup>12)</sup> G = fiber glass  
 S = steel
- <sup>13)</sup> 1 = for motor with hollow shaft  
 2 = for motor with shaft  
 3 = for motor with base
- <sup>14)</sup> 0 = without  
 1 = left  
 2 = right  
 3 = double sided

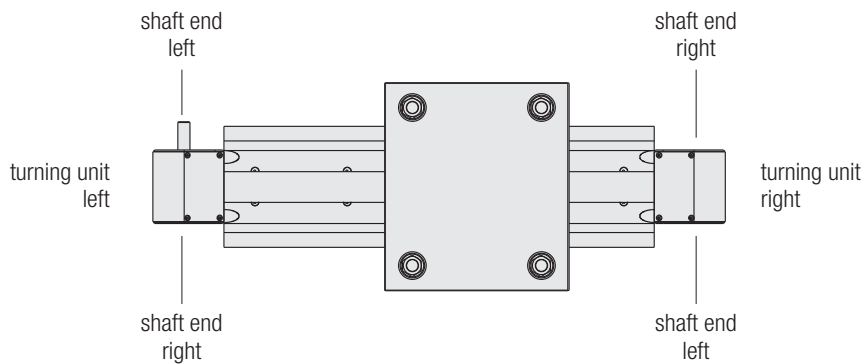

- additional required order information:
- lift
  - carriage length

Linear unit

- with toothed belt drive
- with wheel guide

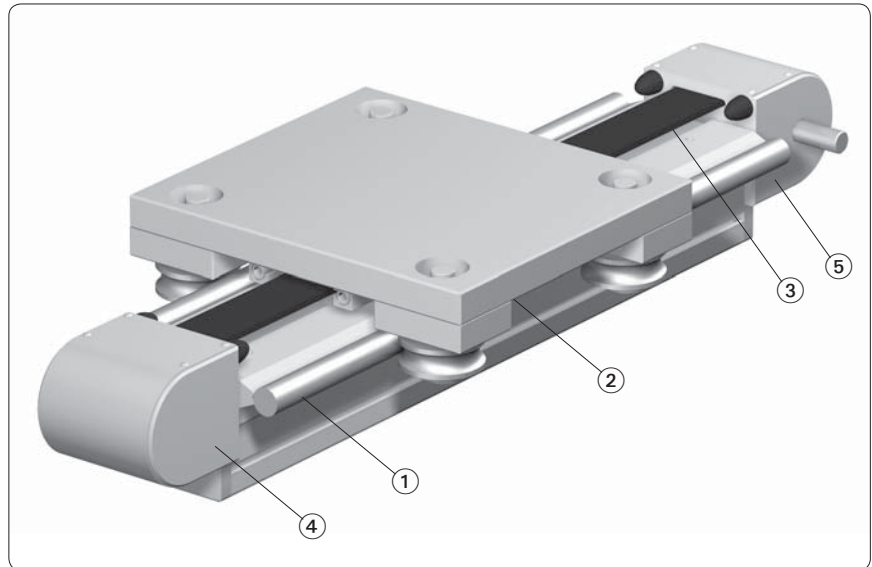

Component groups of linear units

Ordering description:

Article-No.	Description	
4.101...	Linear unit complete including:	
① 4.119...	Linear shaft guidance	
② 4.121...	Carriage unit	<i>(catalogue in preparation)</i>
③ 4.131...	Drive unit	<i>(catalogue in preparation)</i>
④ 4.141...	Turning unit without shaft end	<i>(catalogue in preparation)</i>
⑤ 4.151...	Turning unit with shaft end	<i>(catalogue in preparation)</i>
⑥ 4.161...	Motor flange	<i>(catalogue in preparation)</i>
⑦ 4.171...	Synchronising unit	<i>(catalogue in preparation)</i>
⑧ 4.181...	Gearbox unit	<i>(catalogue in preparation)</i>

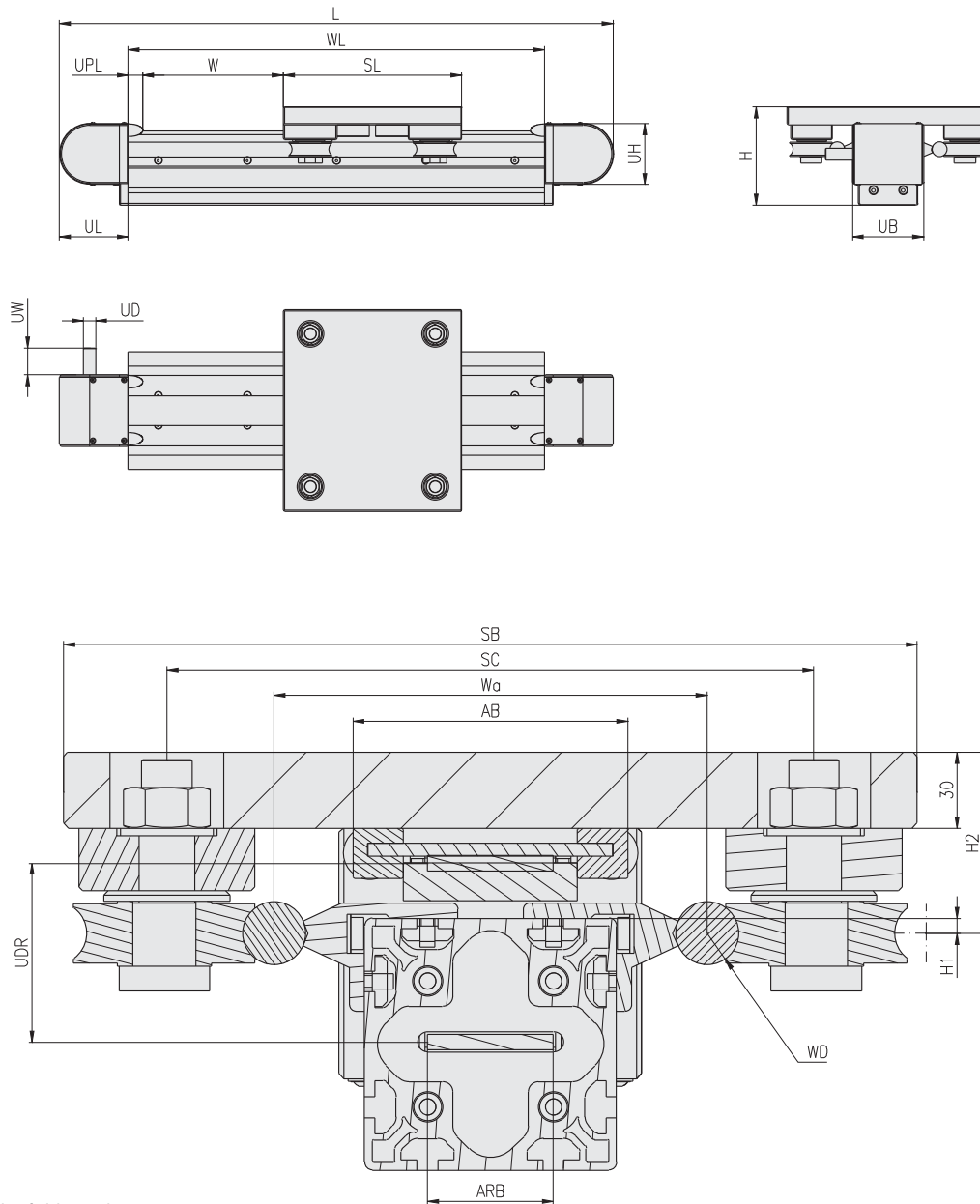

- AB = width of drive unit
- ARB = belt width of drive unit
- H = total height
- H1 = height from shaft center to upper edge of profile
- H2 = height from shaft center to upper edge of carriage
- L = total length
- SB = width of carriage
- SC = center distance from ball bearing to carriage
- SL = length of carriage
- UB = width of turning unit
- UD = shaft end diameter of turning unit
- UDR = pinion diameter of turning unit
- UH = height of turning unit
- UL = length of turning unit
- UPL = parabolic spring length of turning unit
- UW = shaft end length of turning unit
- W = lift
- Wa = axle distance of shaft guidance
- WD = diameter of shaft guidance
- WL = profile length of shaft guidance

Linear unit

- with toothed belt drive
- with ball bearing guide

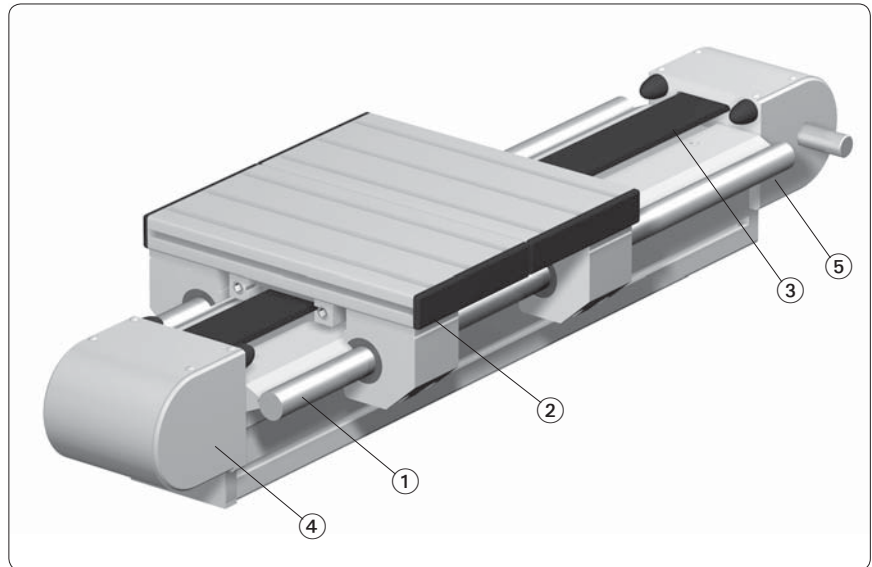

Component groups of linear units

Ordering description:

Article-No.	Description	
4.101...	Linear unit complete including:	
① 4.119...	Linear shaft guidance	
② 4.121...	Carriage unit	(catalogue in preparation)
③ 4.131...	Drive unit	(catalogue in preparation)
④ 4.141...	Turning unit without shaft end	(catalogue in preparation)
⑤ 4.151...	Turning unit with shaft end	(catalogue in preparation)
⑥ 4.161...	Motor flange	(catalogue in preparation)
⑦ 4.171...	Synchronising unit	(catalogue in preparation)
⑧ 4.181...	Gearbox unit	(catalogue in preparation)

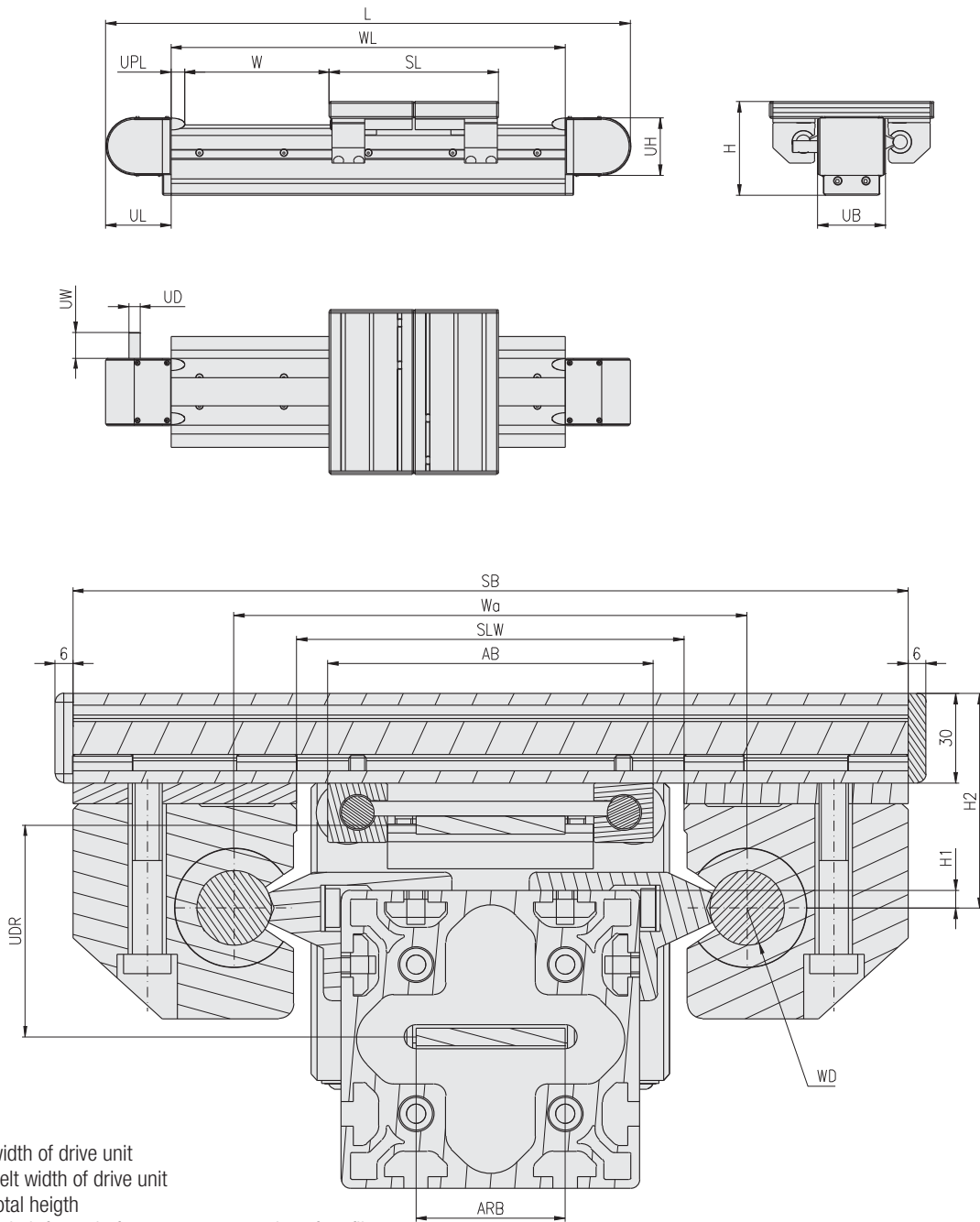

- AB = width of drive unit
- ARB = belt width of drive unit
- H = total height
- H1 = height from shaft center to upper edge of profile
- H2 = height from shaft center to upper edge of carriage
- L = total length
- SB = width of carriage
- SC = center distance from ball bearing to carriage
- SL = length of carriage
- SLW = clear width of carriage
- UB = width of turning unit
- UD = shaft end diameter of turning unit
- UDR = pinion diameter of turning unit
- UH = height of turning unit
- UL = length of turning unit
- UPL = parabolic spring length of turning unit
- UW = shaft end length of turning unit
- W = lift
- Wa = axle distance of shaft guidance
- WD = diameter of shaft guidance
- WL = profile length of shaft guidance

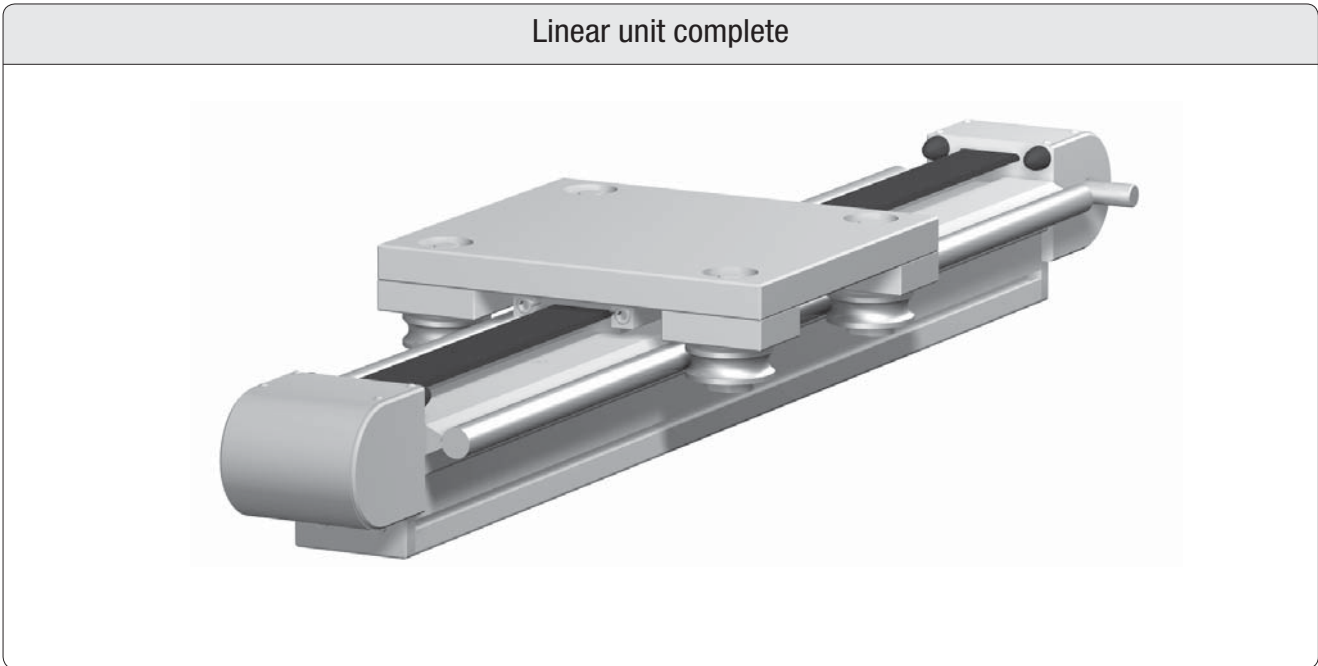

Linear shaft guidance

Single profile design

Frame design

horizontal

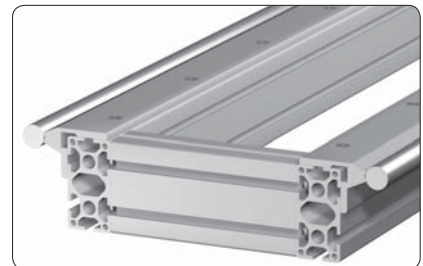
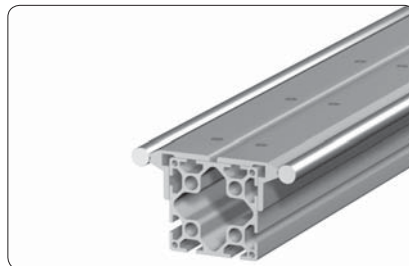

vertical

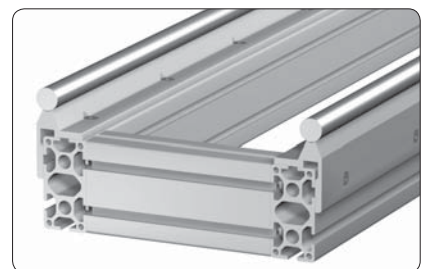
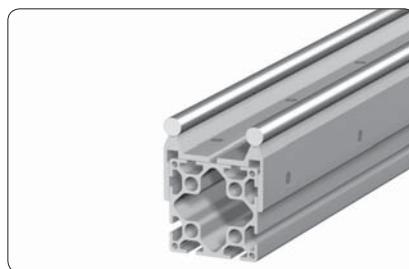

Shaft-Ø

12 mm

16 mm

20 mm

25 mm

Carriage unit

Encased guide block

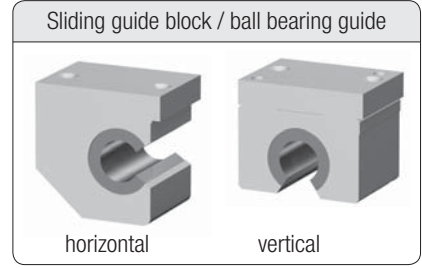
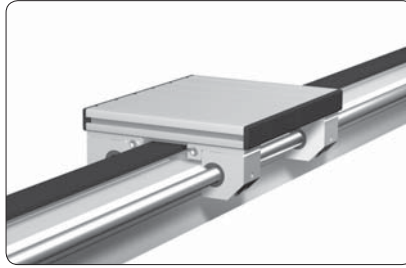

Exposed roller guide

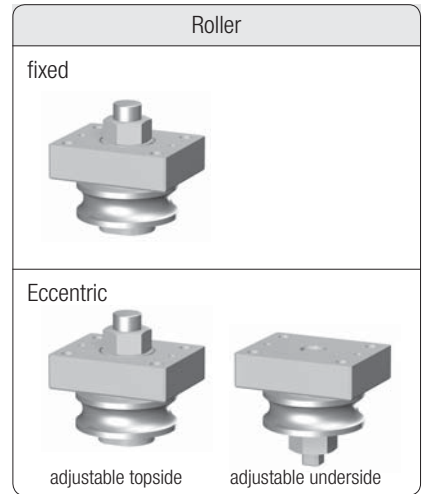
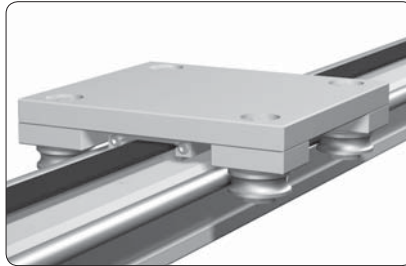

Carriage plates

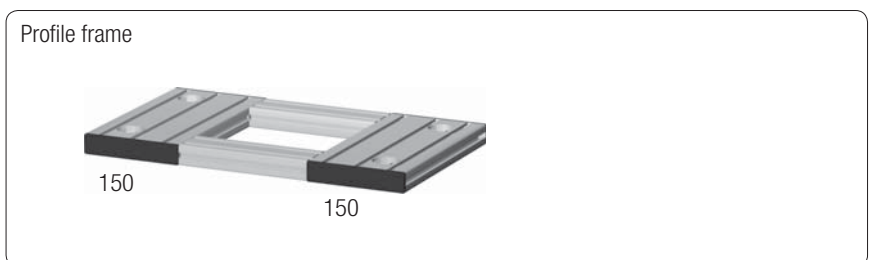
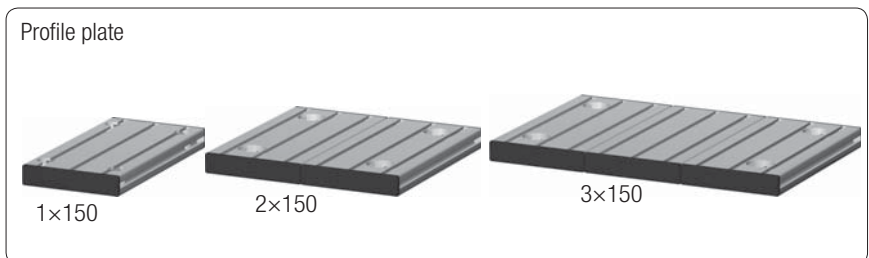
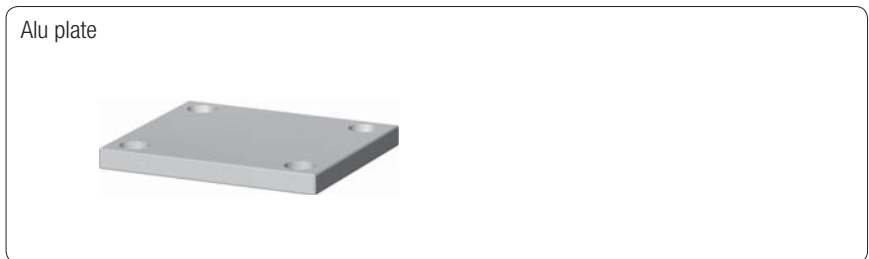

Drive unit

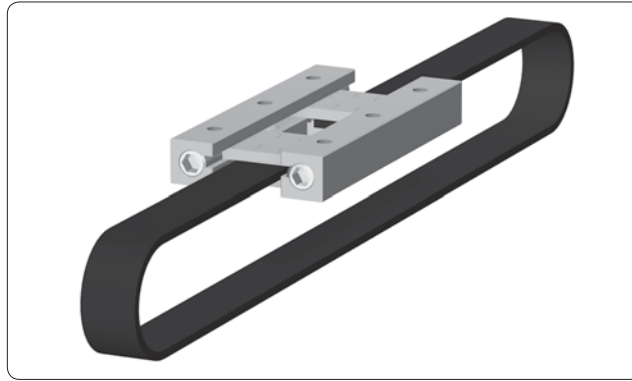

Toothed belt		
-Type:	5M	8M
-width:	15	20
	25	30
		50

Turning unit

Shaft



Shaft

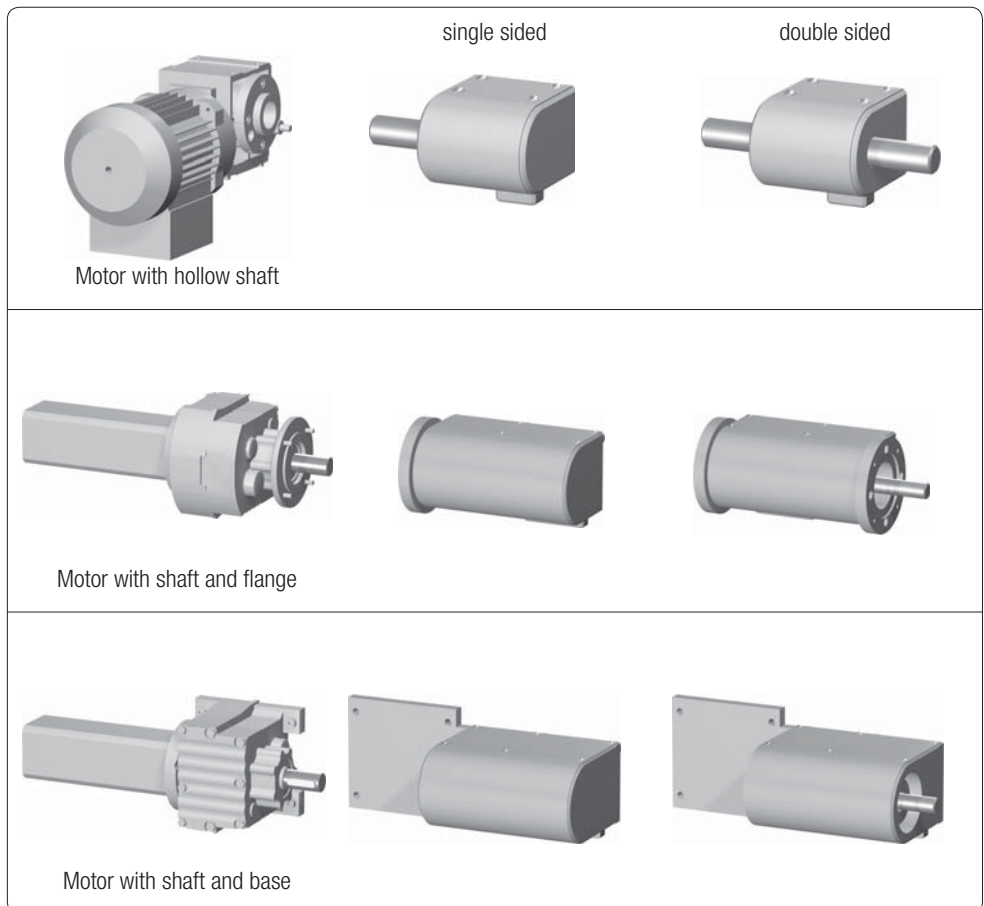





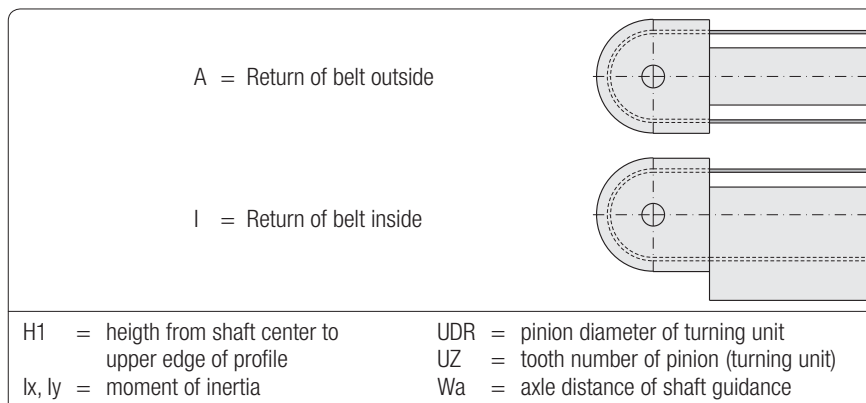

Linear unit complete  
with toothed belt drive  
Shaft guidance  
horizontal



Linear unit complete		Linear shaft guidance						Turning unit					
Design	Article-No.	Profile Dim.	Technical data					Type	Belt 5M		Type	Belt 8M	
			WD	Wa	H1	lx	ly		UZ	UDR		UZ	UDR
	4.101.060060.83LNH22.12...	60×60 L	12	104	4	76	182	100	36	56.2	100	22	54.7
	4.101.060060.83LNH22.16...	60×60 L	16	112	3	80	258	100	36	56.2	100	22	54.7
	4.101.080080.83NH22.12...	80×80	12	124	4	246	377	100	36	56.2	100	24	59.8
	4.101.080080.83NH22.16...	80×80	16	132	3	253	475	100	40	62.5	100	26	64.8
	4.101.080080.83NH22.20...	80×80	20	144	4	283	703	100	40	62.5	100	26	64.8
	4.101.080080.83NH22.25...	80×80	25	152	6	293	984	100	40	62.5	100	26	64.8
	4.101.090090.83LNH22.12...	90×90 L	12	134	4	294	455	100	40	62.5	100	26	64.8
	4.101.090090.83LNH22.16...	90×90 L	16	142	3	309	585	100	40	62.5	100	26	64.8
	4.101.090090.83LNH22.20...	90×90 L	20	154	4	335	829	100	44	68.9	100	28	70.1
	4.101.090090.83LNH22.25...	90×90 L	25	162	6	346	1,148	100	44	68.9	100	28	70.1
	4.101.090090.83NH22.12...	90×90	12	134	4	408	547	150	72	113.5	150	48	120.9
	4.101.090090.83NH22.16...	90×90	16	142	3	430	677	150	72	113.5	150	48	120.9
	4.101.090090.83NH22.20...	90×90	20	154	4	468	921	150	72	113.5	150	48	120.9
	4.101.090090.83NH22.25...	90×90	25	162	6	488	1,240	150	72	113.5	150	48	120.9
	4.101.100100.83NH22.12...	100×100	12	144	4	558	717	100	44	68.9	100	28	70.1
	4.101.100100.83NH22.16...	100×100	16	152	3	583	850	100	44	68.9	100	28	70.1
4.101.100100.83NH22.20...	100×100	20	164	4	635	1,143	100	48	75.3	100	30	75.1	
4.101.100100.83NH22.25...	100×100	25	172	6	661	1,501	100	48	75.3	100	30	75.1	
	4.101.030060.64HH22.12...	30×60	12	104	4	17	158	100	36	56.2	100	22	54.7
	4.101.030060.64HH22.16...	30×60	16	112	3	18	235	100	36	56.2	100	22	54.7
	4.101.030100.84HH22.12...	30×100	12	144	4	24	421	100	36	56.2	100	22	54.7
	4.101.030100.84HH22.16...	30×100	16	152	3	26	554	100	36	56.2	100	22	54.7
	4.101.030150.84HH22.12...	30×150	12	194	4	40	1,115	100	36	56.2	100	22	54.7
	4.101.030150.84HH22.16...	30×150	16	202	3	42	1,341	100	36	56.2	100	22	54.7
	4.101.040080.65HH22.12...	40×80	12	124	4	47	308	100	24	37.1	100	28	70.1
	4.101.040080.65HH22.16...	40×80	16	132	3	49	420	100	24	37.1	100	28	70.1
	4.101.040080.65HH22.20...	40×80	20	144	4	56	634	100	40	62.5	100	28	70.1
	4.101.040080.65HH22.25...	40×80	25	152	6	58	915	100	40	62.5	100	28	70.1
	4.101.040120.84LHH22.12...	40×120 L	12	164	4	49	659	100	44	68.9	100	28	70.1
	4.101.040120.84LHH22.16...	40×120 L	16	172	3	52	826	100	44	68.9	100	28	70.1
	4.101.040120.84LHH22.20...	40×120 L	20	184	4	59	1,199	100	44	68.9	100	28	70.1
	4.101.040120.84LHH22.25...	40×120 L	25	192	6	61	1,643	100	44	68.9	100	28	70.1
	4.101.040160.104LHH22.12...	40×160 L	12	204	4	62	1,263	60	24	37.1	100	28	70.1
	4.101.040160.104LHH22.16...	40×160 L	16	212	3	65	1,510	60	24	37.1	100	28	70.1
	4.101.040160.104LHH22.20...	40×160 L	20	224	4	73	207	60	24	37.1	100	28	70.1
	4.101.040160.104LHH22.25...	40×160 L	25	232	6	75	2,716	60	24	37.1	100	28	70.1
	4.101.045090.64HH22.12...	45×90	12	134	4	63	403	60	24	37.1	100	30	75.1
	4.101.045090.64HH22.16...	45×90	16	142	3	67	532	60	24	37.1	100	30	75.1
	4.101.045090.64HH22.20...	45×90	20	154	4	75	777	60	24	37.1	100	30	75.1
	4.101.045090.64HH22.25...	45×90	25	162	6	77	1,095	60	24	37.1	100	30	75.1
	4.101.050100.65HH22.12...	50×100	12	144	4	93	530	60	28	43.4	100	32	80.2
	4.101.050100.65HH22.16...	50×100	16	152	3	98	663	60	28	43.4	100	32	80.2
4.101.050100.65HH22.20...	50×100	20	164	4	109	956	60	28	43.4	100	32	80.2	
4.101.050100.65HH22.25...	50×100	25	172	6	112	1,314	60	28	43.4	100	32	80.2	

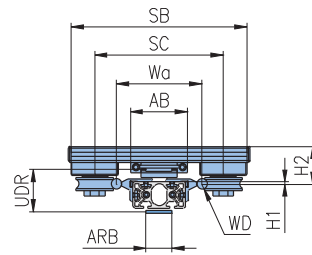
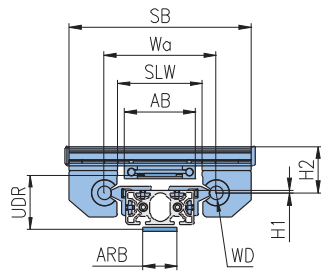

WD = diameter of shaft guidance  
 AB = width of drive unit  
 ARB = belt width of drive unit



H2 = height from shaft center to upper edge of carriage  
 SB = width of carriage

SC = center distance from ball bearing to carriage  
 SLW = clear width of carriage

Carriage																			
Ball bearing guide										Wheel guide									
Return of belt										Return of belt									
5M		8M			SLW	AB	SB	ARB	H2	5M		8M			SC	AB	SB	ARB	H2
15	25	20	30	50						15	25	20	30	50					
					82	82	164	25	65						147.5	98	198	40	65
					86	85	186	25	65						175	105	245	40	65
					102	100	184	50	65						167.5	118	218	50	65
					106	105	206	50	65						195	125	265	60	65
					110	109	230	50	72						226	136	316	75	72
					110	109	260	50	72						239	149	329	90	72
					112	110	194	50	65						177.5	128	228	70	65
					116	115	216	50	65						205	135	275	75	65
					120	115	240	60	72						236	146	326	85	72
					120	115	270	60	72						249	159	339	100	72
A	A	A	A	A	112	110	194	50	65	A	A	A	A	A	177.5	128	228	70	65
A	A	A	A	A	116	115	216	50	65	A	A	A	A	A	205	135	275	75	65
A	A	A	A	A	120	115	240	60	72	A	A	A	A	A	236	146	326	85	72
A	A	A	A	A	120	115	270	60	72	A	A	A	A	A	249	159	339	100	72
					122	120	204	60	65						187.5	138	238	75	65
					126	125	226	65	65						215	145	285	85	65
					130	125	250	70	72						246	156	336	95	72
					130	125	280	70	72						259	169	349	110	72
A					82	82	164	25	65	A	A	A	A		147.5	98	198	40	65
A					86	82	186	25	65	A	A	A	A		175	105	245	45	65
A	A	A	A	A	122	120	204	60	65	A	A	A	A	A	187.5	138	238	75	65
A	A	A	A	A	126	125	226	65	65	A	A	A	A	A	215	145	285	85	65
A	A	A	A	A	172	170	254	110	65	A	A	A	A	A	237.5	188	288	130	65
A	A	A	A	A	176	175	276	115	65	A	A	A	A	A	265	195	335	135	65
		A	A		102	100	184	40	65			A	A	A	167.5	118	218	60	65
		A	A		106	105	206	45	65			A	A	A	195	125	265	65	65
A	A	A	A	A	110	105	230	50	72	A	A	A	A	A	226	136	316	75	72
A	A	A	A	A	110	105	260	50	72	A	A	A	A	A	239	149	329	90	72
A	A	A	A	A	142	140	224	80	65	A	A	A	A	A	207.5	158	258	100	65
A	A	A	A	A	146	145	246	85	65	A	A	A	A	A	235	165	305	100	65
A	A	A	A	A	150	145	270	90	72	A	A	A	A	A	266	176	356	115	72
A	A	A	A	A	150	145	300	90	72	A	A	A	A	A	279	189	369	130	72
		A	A	A	182	180	264	120	65			A	A	A	247.5	198	298	140	65
		A	A	A	186	185	286	125	65			A	A	A	275	205	345	145	65
i	A	A	A	A	190	185	310	130	72	A	A	A	A	A	306	216	396	150	72
	A	A	A	A	190	185	340	130	72	A	A	A	A	A	319	229	409	170	72
		A	A	A	112	110	194	50	65			A	A	A	177.5	128	228	70	65
		A	A	A	116	115	216	50	65			A	A	A	205	135	275	75	65
	A	A	A	A	120	115	240	60	72	A	A	A	A	A	236	146	326	85	72
	A	A	A	A	120	115	270	60	72	A	A	A	A	A	249	159	339	100	72
	A	A	A	A	122	120	204	60	65		A	A	A	A	187.5	138	238	80	65
		A	A	A	126	125	226	65	65			A	A	A	215	145	285	85	65
		A	A	A	130	125	250	70	72			A	A	A	246	156	336	95	72
	A	A	A	A	130	125	280	70	72		A	A	A	A	259	169	349	110	72

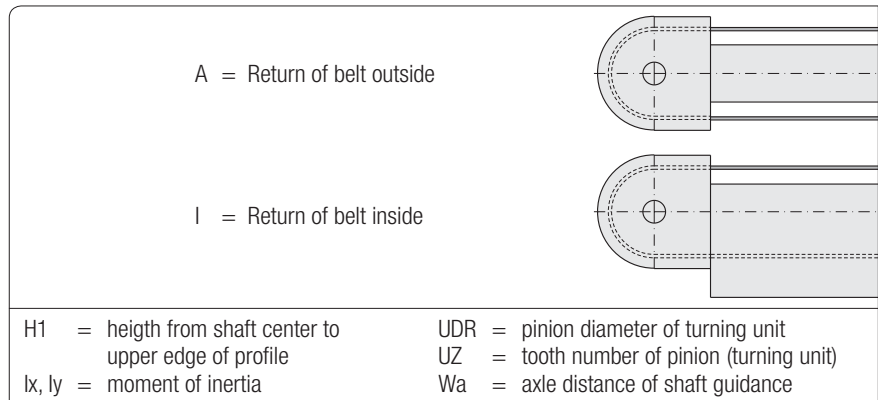
**Linear unit complete**  
**with toothed belt drive**  
 Shaft guidance  
 horizontal



Linear unit complete		Linear shaft guidance						Turning unit					
Design	Article-No.	Profile	Technical data					Type	Belt 5M		Type	Belt 8M	
		Dim.	WD	Wa	H1	lx	ly		UZ	UDR		UZ	UDR
	4.101.050150.65HH22.12...	50×150	12	194	4	122	1,313	100	48	75.3	100	32	80.2
	4.101.050150.85HH22.16...	50×150	16	202	3	129	1,539	100	48	75.3	100	32	80.2
	4.101.050150.85HH22.20...	50×150	20	214	4	141	2,052	100	48	75.3	100	32	80.2
	4.101.050150.85HH22.25...	50×150	25	222	6	144	2,640	100	48	75.3	100	32	80.2
	4.101.080160.124HH22.12...	80×160	12	204	4	380	1,688	60	44	68.9	150	44	110.7
	4.101.080160.124HH22.16...	80×160	16	212	3	397	1,936	60	44	68.9	150	44	110.7
	4.101.080160.124HH22.20...	80×160	20	224	4	430	2,500	100	60	94.4	150	44	110.7
	4.101.080160.124HH22.25...	80×160	25	232	6	446	3,142	100	60	94.4	150	44	110.7
	4.101.100200.124HH22.12...	100×200	12	244	4	953	3,717	100	60	94.4	150	56	141.2
	4.101.100200.124HH22.16...	100×200	16	252	3	985	4,060	100	60	94.4	150	56	141.2
4.101.100200.124HH22.20...	100×200	20	264	4	1,055	4,858	150	60	94.4	150	56	141.2	
4.101.100200.124HH22.25...	100×200	25	272	6	1,096	5,733	150	72	113.5	150	56	141.2	
	4.101.080160.124VH22.12...	80×160	12	124	4	1,376	496	100	40	62.5	100	26	64.8
	4.101.080160.124VH22.16...	80×160	16	132	3	1,441	599	100	40	62.5	100	26	64.8
	4.101.080160.124VH22.20...	80×160	20	144	4	1,580	822	100	40	62.5	100	26	64.8
	4.101.080160.124VH22.25...	80×160	25	152	6	1,666	1,104	100	40	62.5	100	26	64.8
	4.101.100200.124VH22.12...	100×200	12	144	4	3,370	1,088	100	48	75.3	100	30	75.1
	4.101.100200.124VH22.16...	100×200	16	152	3	3,499	1,221	100	48	75.3	100	30	75.1
	4.101.100200.124VH22.20...	100×200	20	164	4	3,799	1,514	100	48	75.3	100	30	75.1
	4.101.100200.124VH22.25...	100×200	25	172	6	4,007	1,872	100	48	75.3	100	30	75.1

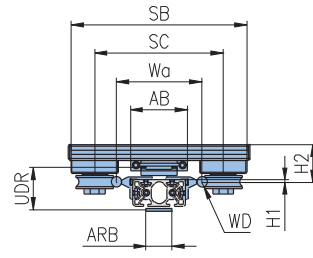
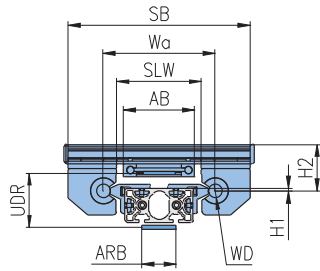

WD = diameter of shaft guidance  
 AB = width of drive unit  
 ARB = belt width of drive unit



H2 = height from shaft center to upper edge of carriage  
 SB = width of carriage

SC = center distance from ball bearing to carriage  
 SLW = clear width of carriage

Carriage																			
Ball bearing guide										Wheel guide									
Return of belt										Return of belt									
5M		8M			SLW	AB	SB	ARB	H2	5M		8M			SC	AB	SB	ARB	H2
15	25	20	30	50						15	25	20	30	50					
A	A	A	A	A	172	170	254	110	65	A	A	A	A	A	237.5	188	288	130	65
A	A	A	A	A	176	175	276	115	65	A	A	A	A	A	265	195	335	135	65
A	A	A	A	A	180	175	300	120	72	A	A	A	A	A	296	206	386	145	72
A	A	A	A	A	180	175	330	120	72	A	A	A	A	A	309	219	399	160	72
I		A	A	A	182	180	264	120	65	I		A	A	A	247.5	198	298	140	65
I		A	A	A	186	185	286	125	65	I		A	A	A	275	205	345	145	65
A	A	A	A	A	190	115	310	130	72	A	A	A	A	A	306	216	396	150	72
A	A	A	A	A	190	185	340	130	72	A	A	A	A	A	319	229	409	170	72
I	I	A	A	A	222	220	304	160	65	I	I	A	A	A	287.5	238	338	180	65
I	I	A	A	A	226	225	326	160	65	I	I	A	A	A	315	245	385	185	65
I	I	A	A	A	230	225	350	170	72	I	I	A	A	A	346	256	436	195	72
A	A	A	A	A	230	225	380	170	72	A	A	A	A	A	359	269	449	210	72
I	I	I	I		102	100	184	30	65	I	I	I	I	I	167.5	118	218	50	65
I	I	I	I	I	106	105	206	50	65	I	I	I	I	I	195	125	265	65	65
I	I	I	I	I	110	105	230	50	72	I	I	I	I	I	226	136	316	75	72
I	I	I	I	I	110	105	260	50	72	I	I	I	I	I	239	149	329	90	72
I	I	I	I	I	122	120	204	60	65	I	I	I	I	I	187.5	138	238	75	65
I	I	I	I	I	126	125	226	65	65	I	I	I	I	I	215	145	285	85	65
I	I	I	I	I	130	125	250	70	72	I	I	I	I	I	246	156	336	95	72
I	I	I	I	I	130	125	280	70	72	I	I	I	I	I	259	169	349	110	72

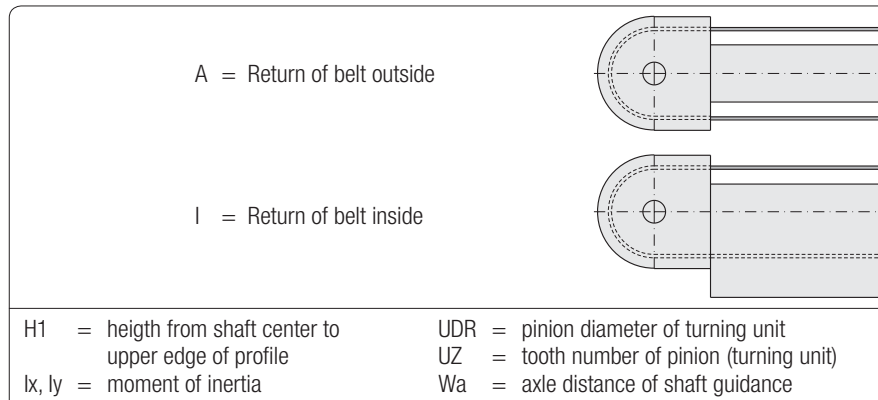
**Linear unit complete**  
**with toothed belt drive**  
 Shaft guidance  
 vertical



Linear unit complete		Linear shaft guidance						Turning unit					
Design	Article-No.	Profile Dim.	Technical data					Type	Belt 5M		Type	Belt 8M	
			WD	Wa	H1	lx	ly		UZ	UDR		UZ	UDR
	4.101.090090.83LNV22.12...	90×90 L	12	82	22	356	364	100	60	94.4	100	34	85.2
	4.101.090090.83LNV22.16...	90×90 L	16	84	26	424	405	100	60	94.4	150	38	95.4
	4.101.090090.83LNV22.20...	90×90 L	20	82	32	533	484	150	72	113.5	150	40	100.5
	4.101.090090.83LNV22.25...	90×90 L	25	78	36	659	542	150	72	113.5	150	44	110.7
	4.101.090090.83NV22.12...	90×90	12	82	22	480	456	100	60	94.4	150	56	141.2
	4.101.090090.83NV22.16...	90×90	16	84	26	565	496	100	60	94.4	150	64	161.6
	4.101.100100.83NV22.12...	100×100	12	92	22	637	617	100	60	94.4	150	38	95.4
	4.101.100100.83NV22.16...	100×100	16	94	26	727	661	100	60	94.4	100	36	90.3
4.101.100100.83NV22.20...	100×100	20	92	32	897	767	150	72	113.5	150	44	110.7	
4.101.100100.83NV22.25...	100×100	25	88	36	1,087	842	150	72	113.5	150	48	120.9	
	4.101.030100.84HV22.12...	30×100	12	92	22	50	321	100	60	94.4	100	32	80.2
	4.101.030100.84HV22.16...	30×100	16	94	26	75	37	100	60	94.4	100	36	90.3
	4.101.030150.84HV22.12...	30×150	12	142	22	71	971	100	60	94.4	100	32	80.2
	4.101.030150.84HV22.16...	30×150	16	144	26	102	1,072	100	60	94.4	100	36	90.3
	4.101.040120.84LHV22.12...	40×120 L	12	112	22	82	82	100	60	94.4	100	36	90.3
	4.101.040120.84LHV22.16...	40×120 L	16	114	26	113	606	100	60	94.4	150	38	95.4
	4.101.040120.84LHV22.20...	40×120 L	20	112	32	170	762	150	72	113.5	150	44	110.7
	4.101.040120.84LHV22.25...	40×120 L	25	108	36	237	879	150	72	113.5	150	48	120.9
	4.101.040160.104LHV22.12...	40×160 L	12	152	22	98	1,111	100	40	62.5	100	36	90.3
	4.101.040160.104LHV22.16...	40×160 L	16	154	26	133	1,225	100	44	68.9	150	40	100.5
	4.101.040160.104LHV22.20...	40×160 L	20	152	32	198	1,515	150	72	113.5	150	44	110.7
	4.101.040160.104LHV22.25...	40×160 L	25	148	36	277	1,742	150	72	113.5	150	48	120.9
	4.101.045090.64HV22.12...	45×90	12	82	22	100	312	100	44	68.9	150	38	95.4
	4.101.045090.64HV22.16...	45×90	16	84	26	135	347	100	48	75.3	150	44	110.7
	4.101.045090.64HV22.20...	45×90	20	82	32	200	431	150	72	113.5	150	44	110.7
	4.101.045090.64HV22.25...	45×90	25	78	36	276	489	150	72	113.5	150	48	120.9
	4.101.050100.65HV22.12...	50×100	12	92	22	135	430	100	40	62.5	150	40	100.5
	4.101.050100.65HV22.16...	50×100	16	94	26	176	474	100	44	68.9	150	44	110.7
	4.101.050100.65HV22.20...	50×100	20	92	32	252	580	100	48	75.3	100	32	80.2
	4.101.050100.65HV22.25...	50×100	25	88	36	341	655	150	72	113.5	150	56	141.2
	4.101.050150.85HV22.12...	50×150	12	142	22	167	1,170	150	72	113.5	150	40	100.5
	4.101.050150.85HV22.16...	50×150	16	144	26	213	1,270	150	72	113.5	150	44	110.7
	4.101.050150.85HV22.20...	50×150	20	142	32	298	1,523	150	72	113.5	150	48	120.9
	4.101.050150.85HV22.25...	50×150	25	138	36	400	1,719	150	72	113.5	150	56	141.2
4.101.080160.124HV22.12...	80×160	12	152	22	446	1,536	100	40	62.5	150	56	141.2	
4.101.080160.124HV22.16...	80×160	16	154	26	519	1,651	100	44	68.9	150	56	141.2	
4.101.080160.124HV22.20...	80×160	20	152	32	656	1,941	100	48	75.3		64	161.6	
4.101.080160.124HV22.25...	80×160	25	148	36	814	2,168					64	161.6	
4.101.100200.124HV22.12...	100×200	12	192	22	1,040	3,530	100	40	62.5		64	161.6	
4.101.100200.124HV22.16...	100×200	16	194	26	1,147	3,711	100	48	75.3		64	161.6	
4.101.100200.124HV22.20...	100×200	20	192	32	1,359	4,176	100	48	75.3		72	182.0	
4.101.100200.124HV22.25...	100×200	25	188	36	1,603	4,550	100	48	75.3		72	182.0	
	4.101.100200.124V22.12...	100×200	12	92	22	3,531	988	100	60	94.4	150	38	95.4
	4.101.100200.124V22.16...	100×200	16	94	26	3,792	1,032	100	60	94.4	100	36	90.3
	4.101.100200.124V22.20...	100×200	20	92	32	4,340	1,138	150	72	113.5	150	44	110.7
	4.101.100200.124V22.25...	100×200	25	88	36	4,901	1,213	150	72	113.5	150	48	120.9

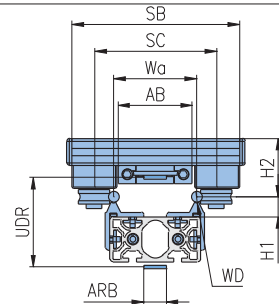
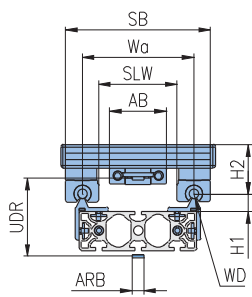

WD = diameter of shaft guidance

H2 = height from shaft center to upper edge of carriage

AB = width of drive unit

SB = width of carriage

ARB = belt width of drive unit

SC = center distance from ball bearing to carriage

SLW = clear width of carriage

Carriage																				
Ball bearing guide										Wheel guide										
Return of belt										Return of belt										
5M		8M									5M		8M							
15	25	20	30	50	SLW	AB	SB	ARB	H2	15	25	20	30	50	SC	AB	SB	ARB	H2	
															125.5	76	176	15	65	
															147	77	217	20	65	
															164	74	254	15	72	
															165	75	255	15	72	
										A				A	125.5	76	176	15	65	
														A	147	77	217	20	65	
															135.5	86	186	25	65	
															157	87	227	30	65	
															174	84	264	25	72	
															175	85	265	25	72	
										A	A	A			135.5	86	186	25	65	
										A	A	A	A		157	87	227	30	65	
A	A	A	A		99	95	188	30	65	A	A	A	A	A	185.5	136	236	75	65	
A	A	A	A		91	95	200	30	65	A	A	A	A	A	207	137	277	75	65	
A					69	70	158	15	65	A	A	A	A	A	155.5	106	206	50	65	
A					61	65	170	15	65	A	A	A	A	A	177	107	247	50	65	
										A	A	A	A	A	194	104	284	45	72	
										A	A	A	A	A	195	105	285	45	72	
		A	A	A	109	105	198	50	65			A	A	A	195.5	146	246	85	65	
		A	A		101	100	210	45	65			A	A	A	217	147	287	85	65	
A	A	A	A		92	95	215	30	72	A	A	A	A	A	234	144	324	85	72	
A					70	70	229	15	72	A	A	A	A	A	235	145	325	85	72	
															125.5	76	176	15	65	
												A			147	77	217	20	65	
															164	74	254	15	72	
															165	75	255	15	72	
										A	A	A		A	135.5	86	186	25	65	
												A	A		157	87	227	30	65	
															174	84	264	25	72	
										A	A	A			175	85	265	25	72	
A	A	A	A		99	95	188	40	65	A	A	A	A	A	185.5	136	236	75	65	
A	A	A	A		91	90	200	30	65	A	A	A	A	A	207	137	277	75	65	
A	A	A			82	80	205	25	72	A	A	A	A	A	224	134	314	75	72	
										A	A	A	A	A	225	135	315	75	72	
		A	A	A	109	105	198	50	65			A	A	A	195.5	146	246	85	65	
		A	A		101	100	210	45	65			A	A	A	217	147	287	85	65	
	A	A	A		92	95	215	30	72			A	A	A	234	144	324	85	72	
					70	70	229	15	72						235	145	325	85	72	
		A	A	A	149	145	238	90	65			A	A	A	235.5	186	286	125	65	
		A	A	A	141	140	250	85	65			A	A	A	257	187	327	130	65	
		A	A	A	132	130	255	70	72			A	A	A	274	184	364	125	72	
A	A	A	A	A	110	105	269	50	72	A	A	A	A	A	275	185	365	125	72	
															135.5	86	186	25	65	
															157	87	227	30	65	
															174	84	264	25	72	
															175	85	265	25	72	

Construction form

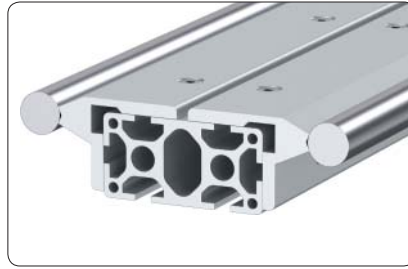

**Position**  
 N = neutral  
 H = horizontal  
 V = vertical

NH  
 (neutral, horizontal)

NV  
 (neutral, vertical)

HH  
 (horizontal, horizontal)

HV  
 (horizontal, vertical)

VH  
 (vertical, horizontal)

VV  
 (vertical, vertical)

Position		Shaft guidance	
Base	Shaft profile	single sided	double sided
N	H	 1)	
N	V	 1)	
H	H	 2)	
H	V	 3)	
V	H	 3)	
V	V	 2)	

1), 2), 3): identical



## Linear shaft guidance, complete

4.119.00.□□□□□□. □□□□□□□□ □□□□ / □□□□ **Key**  
 4.119.00.□□□□□□. □□□□□□□□ □□□□ / □□□□ Profile  
 4.119.00.□□□□□□. □□□□□□□□ □□□□ / □□□□  
 4.119.00.□□□□□□. □□□□□□□□ □□□□ / □□□□ **Shaft**  
 4.119.00.□□□□□□. □□□□□□□□ □□□□ / □□□□  
 4.119.00.□□□□□□. □□□□□□□□ □□□□ / □□□□  
 4.119.00.□□□□□□. □□□□□□□□ □□□□ / □□□□  
 4.119.00.□□□□□□. □□□□□□□□ □□□□ / □□□□  
 4.119.00.□□□□□□. □□□□□□□□ □□□□ / □□□□ **Length**

- dimension
- orientation <sup>1)</sup>
- orientation <sup>2)</sup>
- number <sup>3)</sup>
- assembly <sup>4)</sup>
- Ø
- material <sup>5)</sup>

<sup>1)</sup> H = horizontal  
 N = neutral  
 V = vertical

<sup>2)</sup> H = horizontal  
 V = vertical

<sup>3)</sup> 1 = single sided  
 2 = double sided

<sup>4)</sup> 2 = with guide profile

<sup>5)</sup>	Shaft	mounting elements
	1 = tempering steel	steel, galvanised
	2 = X46Cr13	steel, galvanised
	3 = X46Cr13	VA

**LWF-1 complete**  
 (Linear shaft guidance,  
 single sided)

**Legend**

Descr. = description  
 Dim. = dimension  
 L1 = orientation of base profile  
 L2 = orientation of linear shaft guidance  
 $\emptyset$  = diameter of shaft in mm  
 a = axle distance in mm  
 I<sub>x</sub>, I<sub>y</sub> = moment of inertia in cm<sup>4</sup>  
 G = weight in kg/m

**Orientation**

N = neutral  
 H = horizontal  
 V = vertical

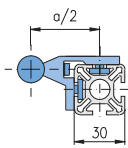

Descr.	Base profile		Shaft		Moment of i.			G	Article-No.
	Dim.	L1	L2	$\emptyset$	a/2	I <sub>x</sub>	I <sub>y</sub>		
LWF-1	30×30	N	H	12	37	9	20	3.0	4.119.00.030030.43NH12.12...
LWF-1	30×30	N	H	16	41	9	31	3.7	4.119.00.030030.43NH12.16...

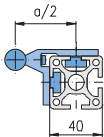

Descr.	Base profile		Shaft		Moment of i.			G	Article-No.
	Dim.	L1	L2	$\emptyset$	a/2	I <sub>x</sub>	I <sub>y</sub>		
LWF-1	40×40	N	H	12	42	24	40	4.2	4.119.00.040040.43NH12.12...
LWF-1	40×40	N	H	16	46	25	56	4.9	4.119.00.040040.43NH12.16...
LWF-1	40×40	N	H	20	52	29	85	6.2	4.119.00.040040.43NH12.20...
LWF-1	40×40	N	H	25	56	30	119	7.8	4.119.00.040040.43NH12.25...

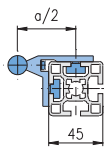

Descr.	Base profile		Shaft		Moment of i.			G	Article-No.
	Dim.	L1	L2	$\emptyset$	a/2	I <sub>x</sub>	I <sub>y</sub>		
LWF-1	45×45	N	H	12	44.5	32	50	4.5	4.119.00.045045.43NH12.12...
LWF-1	45×45	N	H	16	48.5	34	68	5.2	4.119.00.045045.43NH12.16...
LWF-1	45×45	N	H	20	54.5	37	100	6.5	4.119.00.045045.43NH12.20...
LWF-1	45×45	N	H	25	58.5	39	138	8.1	4.119.00.045045.43NH12.25...

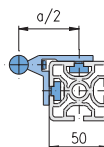

Descr.	Base profile		Shaft		Moment of i.			G	Article-No.
	Dim.	L1	L2	$\emptyset$	a/2	I <sub>x</sub>	I <sub>y</sub>		
LWF-1	50×50	N	H	12	47	46	67	5.3	4.119.00.050050.43NH12.12...
LWF-1	50×50	N	H	16	51	49	88	6.0	4.119.00.050050.43NH12.16...
LWF-1	50×50	N	H	20	57	54	126	7.3	4.119.00.050050.43NH12.20...
LWF-1	50×50	N	H	25	61	56	172	8.9	4.119.00.050050.43NH12.25...

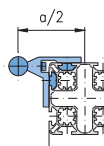

Descr.	Base profile		Shaft		Moment of i.			G	Article-No.	
	Dim.	L1	L2	$\emptyset$	a/2	I <sub>x</sub>	I <sub>y</sub>			kg/m
LWF-1	60×60	L	N	H	12	52	64	87	4.7	4.119.00.060060.83LNH12.12...
LWF-1	60×60	L	N	H	16	56	64	108	5.5	4.119.00.060060.83LNH12.16...

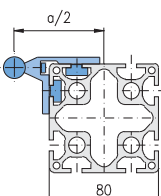

Descr.	Base profile		Shaft		Moment of i.			G	Article-No.
	Dim.	L1	L2	$\emptyset$	a/2	I <sub>x</sub>	I <sub>y</sub>		
LWF-1	80×80	N	H	12	62	205	239	8.1	4.119.00.080080.83NH12.12...
LWF-1	80×80	N	H	16	66	209	272	8.8	4.119.00.080080.83NH12.16...
LWF-1	80×80	N	H	20	72	232	350	10.1	4.119.00.080080.83NH12.20...
LWF-1	80×80	N	H	25	76	241	435	11.7	4.119.00.080080.83NH12.25...

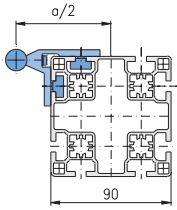

Descr.	Base profile		Shaft		Moment of i.			G	Article-No.	
	Dim.	L1	L2	Ø	a/2	I <sub>x</sub>	I <sub>y</sub>			
LWF-1	90×90	L	N	H	12	67	252	210	7.5	4.119.00.090090.83LNH12.12...
LWF-1	90×90	L	N	H	16	71	280	350	8.2	4.119.00.090090.83LNH12.16...
LWF-1	90×90	L	N	H	20	77	302	432	9.5	4.119.00.090090.83LNH12.20...
LWF-1	90×90	L	N	H	25	81	316	524	11.1	4.119.00.090090.83LNH12.25...

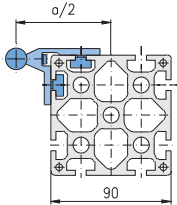

Descr.	Base profile		Shaft		Moment of i.			G	Article-No.	
	Dim.	L1	L2	Ø	a/2	I <sub>x</sub>	I <sub>y</sub>			
LWF-1	90×90		N	H	12	67	346	386	11.7	4.119.00.090090.83NH12.12...
LWF-1	90×90		N	H	16	71	36	437	12.4	4.119.00.090090.83NH12.16...
LWF-1	90×90		N	H	20	77	386	527	13.7	4.119.00.090090.83NH12.20...
LWF-1	90×90		N	H	25	81	402	637	15.3	4.119.00.090090.83NH12.25...

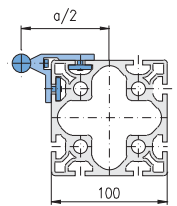

Descr.	Base profile		Shaft		Moment of i.			G	Article-No.	
	Dim.	L1	L2	Ø	a/2	I <sub>x</sub>	I <sub>y</sub>			
LWF-1	100×100		N	H	12	72	479	523	11.9	4.119.00.100100.83NH12.12...
LWF-1	100×100		N	H	16	76	496	577	12.6	4.119.00.100100.83NH12.16...
LWF-1	100×100		N	H	20	82	531	684	13.9	4.119.00.100100.83NH12.20...
LWF-1	100×100		N	H	25	86	552	808	15.5	4.119.00.100100.83NH12.25...

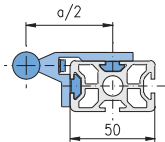

Descr.	Base profile		Shaft		Moment of i.			G	Article-No.	
	Dim.	L1	L2	Ø	a/2	I <sub>x</sub>	I <sub>y</sub>			
LWF-1	30×50		H	H	12	47	13	51	4.1	4.119.00.030050.44HH12.12...
LWF-1	30×50		H	H	16	51	14	69	4.7	4.119.00.030050.44HH12.16...

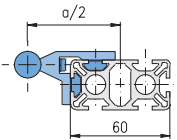

Descr.	Base profile		Shaft		Moment of i.			G	Article-No.	
	Dim.	L1	L2	Ø	a/2	I <sub>x</sub>	I <sub>y</sub>			
LWF-1	30×60		H	H	12	52	13	68	4.2	4.119.00.030060.64HH12.12...
LWF-1	30×60		H	H	16	56	14	87	4.8	4.119.00.030060.64HH12.16...

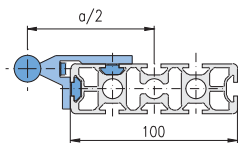

Descr.	Base profile		Shaft		Moment of i.			G	Article-No.	
	Dim.	L1	L2	Ø	a/2	I <sub>x</sub>	I <sub>y</sub>			
LWF-1	30×100		H	H	12	72	19	220	5.5	4.119.00.030100.84HH12.12...
LWF-1	30×100		H	H	16	76	20	260	6.1	4.119.00.030100.84HH12.16...

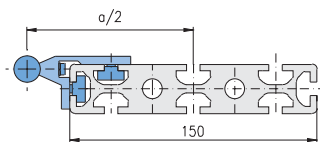

Descr.	Base profile		Shaft		Moment of i.			G	Article-No.	
	Dim.	L1	L2	Ø	a/2	I <sub>x</sub>	I <sub>y</sub>			
LWF-1	30×150		H	H	12	97	33	733	10.0	4.119.00.030150.84HH12.12...
LWF-1	30×150		H	H	16	101	34	819	10.6	4.119.00.030150.84HH12.16...

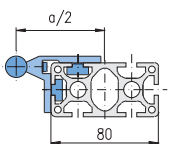

Descr.	Base profile		Shaft		Moment of i.			G	Article-No.	
	Dim.	L1	L2	Ø	a/2	I <sub>x</sub>	I <sub>y</sub>			
LWF-1	40×80		H	H	12	62	36	160	6.0	4.119.00.040080.65HH12.12...
LWF-1	40×80		H	H	16	66	38	193	6.7	4.119.00.040080.65HH12.16...
LWF-1	40×80		H	H	20	72	42	252	8.0	4.119.00.040080.65HH12.20...
LWF-1	40×80		H	H	25	76	44	320	9.6	4.119.00.040080.65HH12.25...

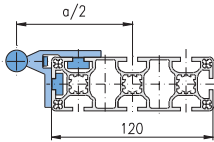

Descr.	Base profile Dim.	Shaft		Moment of i. G	Article-No.
		L1	L2 Ø a/2		
LWF-1	40×120 L H	H 12	82	39 351 5.9	4.119.00.040120.84LHH12.12...
LWF-1	40×120 L H	H 16	86	41 400 6.6	4.119.00.040120.84LHH12.16...
LWF-1	40×120 L H	H 20	92	45 491 7.9	4.119.00.040120.84LHH12.20...
LWF-1	40×120 L H	H 25	96	46 589 9.5	4.119.00.040120.84LHH12.25...

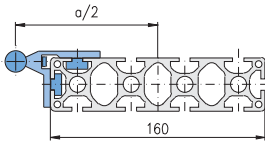

Descr.	Base profile Dim.	Shaft		Moment of i. G	Article-No.
		L1	L2 Ø a/2		
LWF-1	40×160 L H	H 12	102	50 764 7.8	4.119.00.040160.104LHH12.12...
LWF-1	40×160 L H	H 16	106	52 846 8.5	4.119.00.040160.104LHH12.16...
LWF-1	40×160 L H	H 20	112	57 1,007 9.8	4.119.00.040160.104LHH12.20...
LWF-1	40×160 L H	H 25	116	58 1,174 11.4	4.119.00.040160.104LHH12.25...

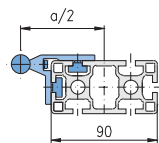

Descr.	Base profile Dim.	Shaft		Moment of i. G	Article-No.
		L1	L2 Ø a/2		
LWF-1	45×90 H	H 12	67	50 226 6.6	4.119.00.045090.64HH12.12...
LWF-1	45×90 H	H 16	71	53 268 7.3	4.119.00.045090.64HH12.16...
LWF-1	45×90 H	H 20	77	58 337 8.6	4.119.00.045090.64HH12.20...
LWF-1	45×90 H	H 25	81	60 420 10.2	4.119.00.045090.64HH12.25...

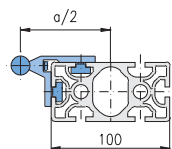

Descr.	Base profile Dim.	Shaft		Moment of i. G	Article-No.
		L1	L2 Ø a/2		
LWF-1	50×100 H	H 12	72	76 324 8.1	4.119.00.050100.65HH12.12...
LWF-1	50×100 H	H 16	76	80 371 8.8	4.119.00.050100.65HH12.16...
LWF-1	50×100 H	H 20	82	87 462 10.1	4.119.00.050100.65HH12.20...
LWF-1	50×100 H	H 25	86	89 565 11.7	4.119.00.050100.65HH12.25...

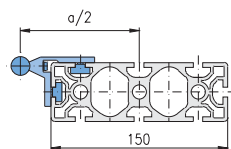

Descr.	Base profile Dim.	Shaft		Moment of i. G	Article-No.
		L1	L2 Ø a/2		
LWF-1	50×150 H	H 12	97	103 894 10.3	4.119.00.050150.85HH12.12...
LWF-1	50×150 H	H 16	101	107 979 11.0	4.119.00.050150.85HH12.16...
LWF-1	50×150 H	H 20	107	115 1,151 12.3	4.119.00.050150.85HH12.20...
LWF-1	50×150 H	H 25	111	118 1,334 13.9	4.119.00.050150.85HH12.25...

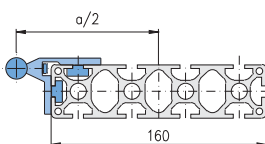

Descr.	Base profile Dim.	Shaft		Moment of i. G	Article-No.
		L1	L2 Ø a/2		
LWF-1	80×160 H	H 12	102	330 1,227 12.7	4.119.00.080160.124HH12.12...
LWF-1	80×160 H	H 16	106	340 1,324 13.4	4.119.00.080160.124HH12.16...
LWF-1	80×160 H	H 20	112	362 1,527 14.7	4.119.00.080160.124HH12.20...
LWF-1	80×160 H	H 25	116	375 1,743 16.3	4.119.00.080160.124HH12.25...

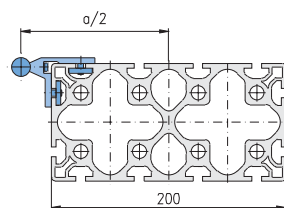

Descr.	Base profile Dim.	Shaft		Moment of i. G	Article-No.
		L1	L2 Ø a/2		
LWF-1	100×200 H	H 12	122	858 3,044 19.7	4.119.00.100200.124HH12.12...
LWF-1	100×200 H	H 16	126	877 3,193 20.4	4.119.00.100200.124HH12.16...
LWF-1	100×200 H	H 20	132	919 3,519 21.7	4.119.00.100200.124HH12.20...
LWF-1	100×200 H	H 25	136	946 3,863 23.3	4.119.00.100200.124HH12.25...

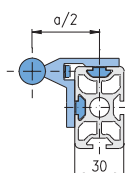

Descr.	Base profile Dim.	Shaft		Moment of i. G	Article-No.
		L1	L2 Ø a/2		
LWF-1	30×50 V	H 12	37	32 26 4.1	4.119.00.030050.44VH12.12...
LWF-1	30×50 V	H 16	41	34 39 4.7	4.119.00.030050.44VH12.16...

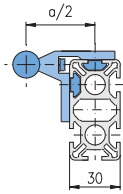

Descr.	Base profile Dim.	Shaft			Moment of i. G			Article-No.	
		L1	L2	Ø	a/2	I <sub>x</sub>	I <sub>y</sub>		kg/m
LWF-1	30×60	V	H	12	37	46	27	4.2	4.119.00.030060.64VH12.12...
LWF-1	30×60	V	H	16	41	49	40	4.8	4.119.00.030060.64VH12.16...

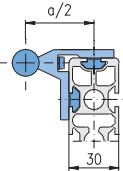

Descr.	Base profile Dim.	Shaft			Moment of i. G			Article-No.	
		L1	L2	Ø	a/2	I <sub>x</sub>	I <sub>y</sub>		kg/m
LWF-1	30×100	V	H	12	37	183	34	5.5	4.119.00.030100.84VH12.12...
LWF-1	30×100	V	H	16	41	193	49	6.1	4.119.00.030100.84VH12.16...

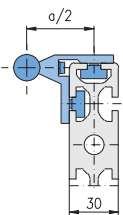

Descr.	Base profile Dim.	Shaft			Moment of i. G			Article-No.	
		L1	L2	Ø	a/2	I <sub>x</sub>	I <sub>y</sub>		kg/m
LWF-1	30×150	V	H	12	37	672	50	10.0	4.119.00.030150.84VH12.12...
LWF-1	30×150	V	H	16	41	707	68	10.6	4.119.00.030150.84VH12.16...

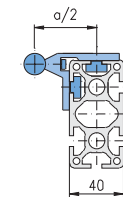

Descr.	Base profile Dim.	Shaft			Moment of i. G			Article-No.	
		L1	L2	Ø	a/2	I <sub>x</sub>	I <sub>y</sub>		kg/m
LWF-1	40×80	V	H	12	42	129	55	6.0	4.119.00.040080.65VH12.12...
LWF-1	40×80	V	H	16	46	136	74	6.7	4.119.00.040080.65VH12.16...
LWF-1	40×80	V	H	20	52	150	110	8.0	4.119.00.040080.65VH12.20...
LWF-1	40×80	V	H	25	56	156	153	9.6	4.119.00.040080.65VH12.25...

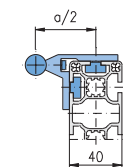

Descr.	Base profile Dim.	Shaft			Moment of i. G			Article-No.	
		L1	L2	Ø	a/2	I <sub>x</sub>	I <sub>y</sub>		kg/m
LWF-1	40×120 L V	H	V	12	42	308	57	5.9	4.119.00.040120.84LVH12.12...
LWF-1	40×120 L V	H	V	16	46	323	76	6.6	4.119.00.040120.84LVH12.16...
LWF-1	40×120 L V	H	V	20	52	112	354	7.9	4.119.00.040120.84LVH12.20...
LWF-1	40×120 L V	H	V	25	56	370	156	9.5	4.119.00.040120.84LVH12.25...

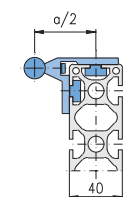

Descr.	Base profile Dim.	Shaft			Moment of i. G			Article-No.	
		L1	L2	Ø	a/2	I <sub>x</sub>	I <sub>y</sub>		kg/m
LWF-1	40×160 L V	H	V	12	42	704	70	7.8	4.119.00.040160.104LVH12.12...
LWF-1	40×160 L V	H	V	16	46	737	91	8.5	4.119.00.040160.104LVH12.16...
LWF-1	40×160 L V	H	V	20	52	810	131	9.8	4.119.00.040160.104LVH12.20...
LWF-1	40×160 L V	H	V	25	56	855	181	11.4	4.119.00.040160.104LVH12.25...

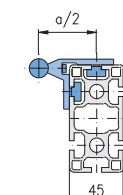

Descr.	Base profile Dim.	Shaft			Moment of i. G			Article-No.	
		L1	L2	Ø	a/2	I <sub>x</sub>	I <sub>y</sub>		kg/m
LWF-1	45×90	V	H	12	44.5	191	71	6.6	4.119.00.045090.64VH12.12...
LWF-1	45×90	V	H	16	48.5	200	92	7.3	4.119.00.045090.64VH12.16...
LWF-1	45×90	V	H	20	54.5	220	133	8.6	4.119.00.045090.64VH12.20...
LWF-1	45×90	V	H	25	58.5	229	183	10.2	4.119.00.045090.64VH12.25...

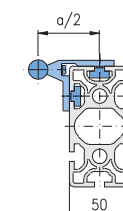

Descr.	Base profile Dim.	Shaft			Moment of i. G			Article-No.	
		L1	L2	Ø	a/2	I <sub>x</sub>	I <sub>y</sub>		kg/m
LWF-1	50×100	V	H	12	47	283	100	8.1	4.119.00.050100.65VH12.12...
LWF-1	50×100	V	H	16	51	297	124	8.8	4.119.00.050100.65VH12.16...
LWF-1	50×100	V	H	20	57	325	172	10.1	4.119.00.050100.65VH12.20...
LWF-1	50×100	V	H	25	61	340	230	11.7	4.119.00.050100.65VH12.25...

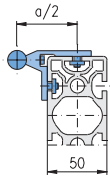

Descr.	Base profile Dim.	Shaft		Moment of i. G			Article-No.	
		L1	L2 Ø	a/2	I <sub>x</sub>	I <sub>y</sub>		kg/m
LWF-1	50×150 V	H	12	47	833	128	10.3	4.119.00.050150.85VH12.12...
LWF-1	50×150 V	H	16	51	868	154	11.0	4.119.00.050150.85VH12.16...
LWF-1	50×150 V	H	20	57	945	206	12.3	4.119.00.050150.85VH12.20...
LWF-1	50×150 V	H	25	61	995	271	13.9	4.119.00.050150.85VH12.25...

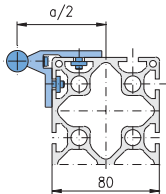

Descr.	Base profile Dim.	Shaft		Moment of i. G			Article-No.	
		L1	L2 Ø	a/2	I <sub>x</sub>	I <sub>y</sub>		kg/m
LWF-1	80×160 V	H	12	62	1,160	366	12.7	4.119.00.080160.124VH12.12...
LWF-1	80×160 V	H	16	66	1,202	409	13.4	4.119.00.080160.124VH12.16...
LWF-1	80×160 V	H	20	72	1,299	493	14.7	4.119.00.080160.124VH12.20...
LWF-1	80×160 V	H	25	76	1,365	594	16.3	4.119.00.080160.124VH12.25...

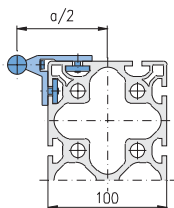

Descr.	Base profile Dim.	Shaft		Moment of i. G			Article-No.	
		L1	L2 Ø	a/2	I <sub>x</sub>	I <sub>y</sub>		kg/m
LWF-1	100×200 V	H	12	72	2,958	904	19.7	4.119.00.100200.124VH12.12...
LWF-1	100×200 V	H	16	76	3,034	964	20.4	4.119.00.100200.124VH12.16...
LWF-1	100×200 V	H	20	82	3,218	1,087	21.7	4.119.00.100200.124VH12.20...
LWF-1	100×200 V	H	25	86	3,355	1,232	23.3	4.119.00.100200.124VH12.25...

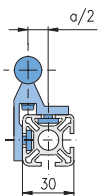

Descr.	Base profile Dim.	Shaft		Moment of i. G			Article-No.	
		L1	L2 Ø	a/2	I <sub>x</sub>	I <sub>y</sub>		kg/m
LWF-1	30×30 N	V	12	11	20	9	3.0	4.119.00.030030.43NV12.12...
LWF-1	30×30 N	V	16	12	31	9	3.7	4.119.00.030030.43NV12.16...

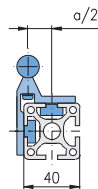

Descr.	Base profile Dim.	Shaft		Moment of i. G			Article-No.	
		L1	L2 Ø	a/2	I <sub>x</sub>	I <sub>y</sub>		kg/m
LWF-1	40×40 N	V	12	16	40	24	4.2	4.119.00.040040.43NV12.12...
LWF-1	40×40 N	V	16	17	56	25	4.9	4.119.00.040040.43NV12.16...
LWF-1	40×40 N	V	20	16	85	29	6.2	4.119.00.040040.43NV12.20...
LWF-1	40×40 N	V	25	14	119	30	7.8	4.119.00.040040.43NV12.25...

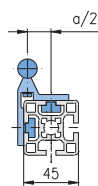

Descr.	Base profile Dim.	Shaft		Moment of i. G			Article-No.	
		L1	L2 Ø	a/2	I <sub>x</sub>	I <sub>y</sub>		kg/m
LWF-1	45×45 N	V	12	18.5	50	32	4.5	4.119.00.045045.43NV12.12...
LWF-1	45×45 N	V	16	19.5	68	34	5.2	4.119.00.045045.43NV12.16...
LWF-1	45×45 N	V	20	18.5	100	37	6.5	4.119.00.045045.43NV12.20...
LWF-1	45×45 N	V	25	16.5	138	39	8.1	4.119.00.045045.43NV12.25...

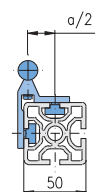

Descr.	Base profile Dim.	Shaft		Moment of i. G			Article-No.	
		L1	L2 Ø	a/2	I <sub>x</sub>	I <sub>y</sub>		kg/m
LWF-1	50×50 N	V	12	21	67	46	5.3	4.119.00.050050.43NV12.12...
LWF-1	50×50 N	V	16	22	88	49	6.0	4.119.00.050050.43NV12.16...
LWF-1	50×50 N	V	20	21	126	54	7.3	4.119.00.050050.43NV12.20...
LWF-1	50×50 N	V	25	19	172	56	8.9	4.119.00.050050.43NV12.25...

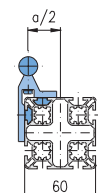

Descr.	Base profile Dim.	Shaft		Moment of i. G			Article-No.		
		L1	L2 Ø	a/2	I <sub>x</sub>	I <sub>y</sub>		kg/m	
LWF-1	60×60 L	N	V	12	26	87	64	4.7	4.119.00.060060.83LNV12.12...
LWF-1	60×60 L	N	V	16	27	108	64	5.5	4.119.00.060060.83LNV12.16...

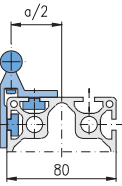

Descr.	Base profile Dim.	Shaft		Moment of i. G			Article-No.	
		L1	L2 Ø	a/2	I <sub>x</sub>	I <sub>y</sub>		kg/m
LWF-1	80×80	N	V 12	36	239	205	8.1	4.119.00.080080.83NV12.12...
LWF-1	80×80	N	V 16	37	272	209	8.8	4.119.00.080080.83NV12.16...
LWF-1	80×80	N	V 20	36	350	232	10.1	4.119.00.080080.83NV12.20...
LWF-1	80×80	N	V 25	34	435	241	11.7	4.119.00.080080.83NV12.25...

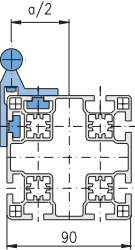

Descr.	Base profile Dim.	Shaft		Moment of i. G			Article-No.	
		L1	L2 Ø	a/2	I <sub>x</sub>	I <sub>y</sub>		kg/m
LWF-1	90×90 L	N	V 12	41	290	252	7.5	4.119.00.090090.83LNV12.12...
LWF-1	90×90 L	N	V 16	41	350	280	8.2	4.119.00.090090.83LNV12.16...
LWF-1	90×90 L	N	V 20	41	432	302	9.5	4.119.00.090090.83LNV12.20...
LWF-1	90×90 L	N	V 25	39	524	316	11.1	4.119.00.090090.83LNV12.25...

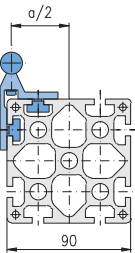

Descr.	Base profile Dim.	Shaft		Moment of i. G			Article-No.	
		L1	L2 Ø	a/2	I <sub>x</sub>	I <sub>y</sub>		kg/m
LWF-1	90×90	N	V 12	41	386	346	11.7	4.119.00.090090.83NV12.12...
LWF-1	90×90	N	V 16	41	437	360	12.4	4.119.00.090090.83NV12.16...
LWF-1	90×90	N	V 20	41	527	386	13.7	4.119.00.090090.83NV12.20...
LWF-1	90×90	N	V 25	39	637	402	15.3	4.119.00.090090.83NV12.25...

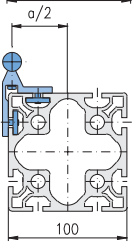

Descr.	Base profile Dim.	Shaft		Moment of i. G			Article-No.	
		L1	L2 Ø	a/2	I <sub>x</sub>	I <sub>y</sub>		kg/m
LWF-1	100×100	N	V 12	46	523	479	11.9	4.119.00.100100.83NV12.12...
LWF-1	100×100	N	V 16	47	577	496	12.6	4.119.00.100100.83NV12.16...
LWF-1	100×100	N	V 20	46	684	531	13.9	4.119.00.100100.83NV12.20...
LWF-1	100×100	N	V 25	44	808	552	15.5	4.119.00.100100.83NV12.25...

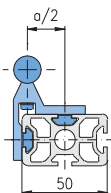

Descr.	Base profile Dim.	Shaft		Moment of i. G			Article-No.	
		L1	L2 Ø	a/2	I <sub>x</sub>	I <sub>y</sub>		kg/m
LWF-1	30×50	H	V 12	21	26	32	4.1	4.119.00.030050.44HV12.12...
LWF-1	30×50	H	V 16	22	39	34	4.7	4.119.00.030050.44HV12.16...

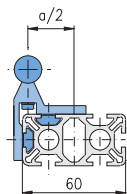

Descr.	Base profile Dim.	Shaft		Moment of i. G			Article-No.	
		L1	L2 Ø	a/2	I <sub>x</sub>	I <sub>y</sub>		kg/m
LWF-1	30×60	H	V 12	26	27	46	4.2	4.119.00.030060.64HV12.12...
LWF-1	30×60	H	V 16	27	40	49	4.8	4.119.00.030060.64HV12.16...

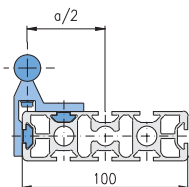

Descr.	Base profile Dim.	Shaft		Moment of i. G			Article-No.	
		L1	L2 Ø	a/2	I <sub>x</sub>	I <sub>y</sub>		kg/m
LWF-1	30×100	H	V 12	46	34	183	5.5	4.119.00.030100.84HV12.12...
LWF-1	30×100	H	V 16	47	49	193	6.1	4.119.00.030100.84HV12.16...

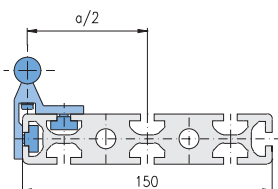

Descr.	Base profile Dim.	Shaft		Moment of i. G			Article-No.	
		L1	L2 Ø	a/2	I <sub>x</sub>	I <sub>y</sub>		kg/m
LWF-1	30×150	H	V 12	71	50	672	10.0	4.119.00.030150.84HV12.12...
LWF-1	30×150	H	V 16	72	68	707	10.6	4.119.00.030150.84HV12.16...

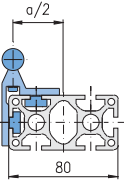

Descr.	Base profile Dim.	Shaft L1 L2 Ø	Moment of i. G lx ly kg/m	Article-No.
LWF-1	40×80	H V 12 36	55 129 6.0	4.119.00.040080.65HV12.12...
LWF-1	40×80	H V 16 37	74 136 6.7	4.119.00.040080.65HV12.16...
LWF-1	40×80	H V 20 36	110 150 8.0	4.119.00.040080.65HV12.20...
LWF-1	40×80	H V 25 34	153 156 9.6	4.119.00.040080.65HV12.25...

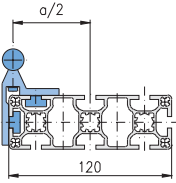

Descr.	Base profile Dim.	Shaft L1 L2 Ø	Moment of i. G lx ly kg/m	Article-No.
LWF-1	40×120 L H	V 12 56	57 308 5.9	4.119.00.040120.84LHV12.12...
LWF-1	40×120 L H	V 16 57	76 323 6.6	4.119.00.040120.84LHV12.16...
LWF-1	40×120 L H	V 20 56	354 112 7.9	4.119.00.040120.84LHV12.20...
LWF-1	40×120 L H	V 25 54	156 370 9.5	4.119.00.040120.84LHV12.25...

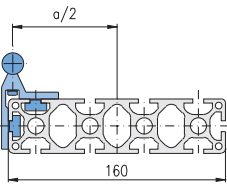

Descr.	Base profile Dim.	Shaft L1 L2 Ø	Moment of i. G lx ly kg/m	Article-No.
LWF-1	40×160 L H	V 12 76	70 704 7.8	4.119.00.040160.104LHV12.12...
LWF-1	40×160 L H	V 16 77	91 737 8.5	4.119.00.040160.104LHV12.16...
LWF-1	40×160 L H	V 20 76	131 810 9.8	4.119.00.040160.104LHV12.20...
LWF-1	40×160 L H	V 25 74	181 855 11.4	4.119.00.040160.104LHV12.25...

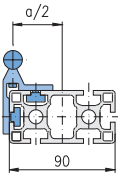

Descr.	Base profile Dim.	Shaft L1 L2 Ø	Moment of i. G lx ly kg/m	Article-No.
LWF-1	45×90	H V 12 41	71 191 6.6	4.119.00.045090.64HV12.12...
LWF-1	45×90	H V 16 42	92 200 7.3	4.119.00.045090.64HV12.16...
LWF-1	45×90	H V 20 41	133 220 8.6	4.119.00.045090.64HV12.20...
LWF-1	45×90	H V 25 39	183 229 10.2	4.119.00.045090.64HV12.25...

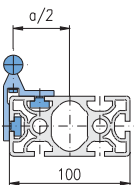

Descr.	Base profile Dim.	Shaft L1 L2 Ø	Moment of i. G lx ly kg/m	Article-No.
LWF-1	50×100	H V 12 46	100 283 8.1	4.119.00.050100.65HV12.12...
LWF-1	50×100	H V 16 47	124 297 8.8	4.119.00.050100.65HV12.16...
LWF-1	50×100	H V 20 46	172 325 10.1	4.119.00.050100.65HV12.20...
LWF-1	50×100	H V 25 44	230 340 11.7	4.119.00.050100.65HV12.25...

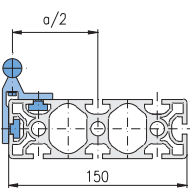

Descr.	Base profile Dim.	Shaft L1 L2 Ø	Moment of i. G lx ly kg/m	Article-No.
LWF-1	50×150	H V 12 71	128 833 10.3	4.119.00.050150.85HV12.12...
LWF-1	50×150	H V 16 72	154 868 11.0	4.119.00.050150.85HV12.16...
LWF-1	50×150	H V 20 71	206 945 12.3	4.119.00.050150.85HV12.20...
LWF-1	50×150	H V 25 69	271 995 13.9	4.119.00.050150.85HV12.25...

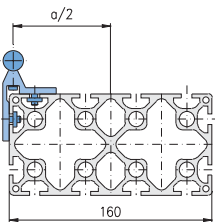

Descr.	Base profile Dim.	Shaft L1 L2 Ø	Moment of i. G lx ly kg/m	Article-No.
LWF-1	80×160	H V 12 76	366 1,160 12.7	4.119.00.080160.124HV12.12...
LWF-1	80×160	H V 16 77	409 1,202 13.4	4.119.00.080160.124HV12.16...
LWF-1	80×160	H V 20 76	493 1,299 14.7	4.119.00.080160.124HV12.20...
LWF-1	80×160	H V 25 74	594 1,365 16.3	4.119.00.080160.124HV12.25...

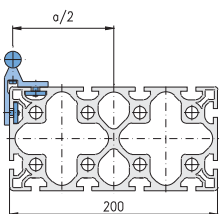

Descr.	Base profile Dim.	Shaft L1 L2 Ø	Moment of i. G lx ly kg/m	Article-No.
LWF-1	100×200	H V 12 96	904 2,958 19.7	4.119.00.100200.124HV12.12...
LWF-1	100×200	H V 16 97	964 3,034 20.4	4.119.00.100200.124HV12.16...
LWF-1	100×200	H V 20 96	1,087 3,218 21.7	4.119.00.100200.124HV12.20...
LWF-1	100×200	H V 25 94	1,232 3,355 23.3	4.119.00.100200.124HV12.25...



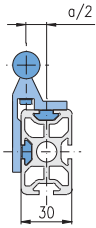

Descr.	Base profile Dim.	Shaft			Moment of i. G			Article-No.	
		L1	L2	Ø	a/2	I <sub>x</sub>	I <sub>y</sub>		kg/m
LWF-1	30×50	V	V	12	11	51	13	4.1	4.119.00.030050.44VV12.12...
LWF-1	30×50	V	V	16	12	69	14	4.7	4.119.00.030050.44VV12.16...

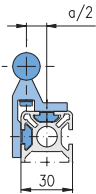

Descr.	Base profile Dim.	Shaft			Moment of i. G			Article-No.	
		L1	L2	Ø	a/2	I <sub>x</sub>	I <sub>y</sub>		kg/m
LWF-1	30×60	V	V	12	11	68	13	4.2	4.119.00.030060.64VV12.12...
LWF-1	30×60	V	V	16	12	87	14	4.8	4.119.00.030060.64VV12.16...

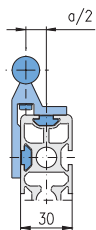

Descr.	Base profile Dim.	Shaft			Moment of i. G			Article-No.	
		L1	L2	Ø	a/2	I <sub>x</sub>	I <sub>y</sub>		kg/m
LWF-1	30×100	V	V	12	11	220	19	5.5	4.119.00.030100.84VV12.12...
LWF-1	30×100	V	V	16	12	260	20	6.1	4.119.00.030100.84VV12.16...

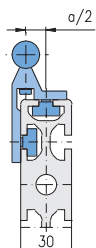

Descr.	Base profile Dim.	Shaft			Moment of i. G			Article-No.	
		L1	L2	Ø	a/2	I <sub>x</sub>	I <sub>y</sub>		kg/m
LWF-1	30×150	V	V	12	11	733	33	10.0	4.119.00.030150.84VV12.12...
LWF-1	30×150	V	V	16	12	819	34	10.6	4.119.00.030150.84VV12.16...

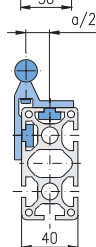

Descr.	Base profile Dim.	Shaft			Moment of i. G			Article-No.	
		L1	L2	Ø	a/2	I <sub>x</sub>	I <sub>y</sub>		kg/m
LWF-1	40×80	V	V	12	16	160	36	6.0	4.119.00.040080.65VV12.12...
LWF-1	40×80	V	V	16	17	193	38	6.7	4.119.00.040080.65VV12.16...
LWF-1	40×80	V	V	20	16	252	42	8.0	4.119.00.040080.65VV12.20...
LWF-1	40×80	V	V	25	14	320	44	9.6	4.119.00.040080.65VV12.25...

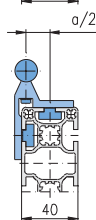

Descr.	Base profile Dim.	Shaft			Moment of i. G			Article-No.	
		L1	L2	Ø	a/2	I <sub>x</sub>	I <sub>y</sub>		kg/m
LWF-1	40×120 L	V	V	12	16	351	39	5.9	4.119.00.040120.84LW12.12...
LWF-1	40×120 L	V	V	16	17	400	41	6.6	4.119.00.040120.84LW12.16...
LWF-1	40×120 L	V	V	20	16	491	45	7.9	4.119.00.040120.84LW12.20...
LWF-1	40×120 L	V	V	25	14	589	46	9.5	4.119.00.040120.84LW12.25...

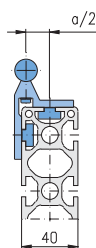

Descr.	Base profile Dim.	Shaft			Moment of i. G			Article-No.	
		L1	L2	Ø	a/2	I <sub>x</sub>	I <sub>y</sub>		kg/m
LWF-1	40×160 L	V	V	12	16	764	50	7.8	4.119.00.040160.104LW12.12...
LWF-1	40×160 L	V	V	16	17	846	52	8.5	4.119.00.040160.104LW12.16...
LWF-1	40×160 L	V	V	20	16	1,007	57	9.8	4.119.00.040160.104LW12.20...
LWF-1	40×160 L	V	V	25	14	1,174	58	11.4	4.119.00.040160.104LW12.25...

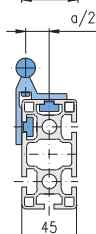

Descr.	Base profile Dim.	Shaft			Moment of i. G			Article-No.	
		L1	L2	Ø	a/2	I <sub>x</sub>	I <sub>y</sub>		kg/m
LWF-1	45×90	V	V	12	18.5	226	50	6.6	4.119.00.045090.64VV12.12...
LWF-1	45×90	V	V	16	18.5	268	53	7.3	4.119.00.045090.64VV12.16...
LWF-1	45×90	V	V	20	18.5	337	58	8.6	4.119.00.045090.64VV12.20...
LWF-1	45×90	V	V	25	16.5	420	60	10.2	4.119.00.045090.64VV12.25...

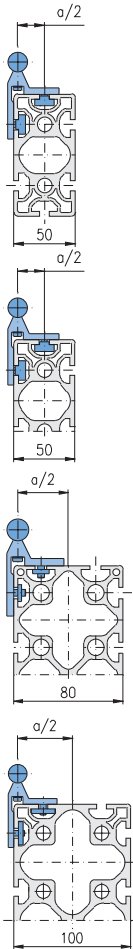

Descr.	Base profile		Shaft		Moment of i.			G	Article-No.
	Dim.	L1	L2	Ø	a/2	I <sub>x</sub>	I <sub>y</sub>		
LWF-1	50×100	V	V	12	21	324	76	8.1	4.119.00.050100.65W12.12...
LWF-1	50×100	V	V	16	22	371	80	8.8	4.119.00.050100.65W12.16...
LWF-1	50×100	V	V	20	21	462	87	10.1	4.119.00.050100.65W12.20...
LWF-1	50×100	V	V	25	19	565	89	11.7	4.119.00.050100.65W12.25...

Descr.	Base profile		Shaft		Moment of i.			G	Article-No.
	Dim.	L1	L2	Ø	a/2	I <sub>x</sub>	I <sub>y</sub>		
LWF-1	50×150	V	V	12	21	894	103	10.3	4.119.00.050150.85W12.12...
LWF-1	50×150	V	V	16	22	979	107	11.0	4.119.00.050150.85W12.16...
LWF-1	50×150	V	V	20	21	1,151	115	12.3	4.119.00.050150.85W12.20...
LWF-1	50×150	V	V	25	19	1,334	118	13.9	4.119.00.050150.85W12.25...

Descr.	Base profile		Shaft		Moment of i.			G	Article-No.
	Dim.	L1	L2	Ø	a/2	I <sub>x</sub>	I <sub>y</sub>		
LWF-1	80×160	V	V	12	36	1,227	330	12.7	4.119.00.080160.124W12.12...
LWF-1	80×160	V	V	16	37	1,324	340	13.4	4.119.00.080160.124W12.16...
LWF-1	80×160	V	V	20	36	1,527	362	14.7	4.119.00.080160.124W12.20...
LWF-1	80×160	V	V	25	34	1,743	375	16.3	4.119.00.080160.124W12.25...

Descr.	Base profile		Shaft		Moment of i.			G	Article-No.
	Dim.	L1	L2	Ø	a/2	I <sub>x</sub>	I <sub>y</sub>		
LWF-1	100×200	V	V	12	46	3,044	858	19.7	4.119.00.100200.124W12.12...
LWF-1	100×200	V	V	16	47	3,193	877	20.4	4.119.00.100200.124W12.16...
LWF-1	100×200	V	V	20	46	3,519	919	21.7	4.119.00.100200.124W12.20...
LWF-1	100×200	V	V	25	44	3,863	946	23.3	4.119.00.100200.124W12.25...

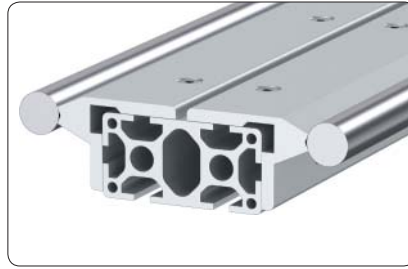
**LWF-2 complete**  
 (Linear shaft guidance,  
 double sided)

**Legend**

Descr. = description  
 Dim. = dimension  
 L1 = orientation of base profile  
 L2 = orientation of linear shaft guidance  
 $\emptyset$  = diameter of shaft in mm  
 a = axle distance in mm  
 Ix, Iy = moment of inertia in cm<sup>4</sup>  
 G = weight in kg/m

**Orientation**

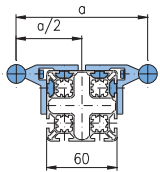
N = neutral  
 H = horizontal  
 V = vertical



Descr.	Base profile		Shaft		Moment of i.			G	Article-No.	
	Dim.	L1	L2	$\emptyset$	a	Ix	Iy			kg/m
LWF-2	60×60	L	N	H	12	104	76	182	6.7	4.119.00.060060.83LNH22.12...
LWF-2	60×60	L	N	H	16	112	80	258	8.1	4.119.00.060060.83LNH22.16...

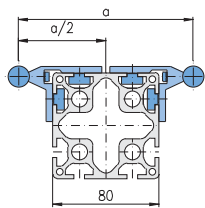

Descr.	Base profile		Shaft		Moment of i.			G	Article-No.	
	Dim.	L1	L2	$\emptyset$	a	Ix	Iy			kg/m
LWF-2	80×80	N	H	H	12	124	246	377	10.3	4.119.00.080080.83NH22.12...
LWF-2	80×80	N	H	H	16	132	253	475	11.7	4.119.00.080080.83NH22.16...
LWF-2	80×80	N	H	H	20	144	283	703	14.2	4.119.00.080080.83NH22.20...
LWF-2	80×80	N	H	H	25	152	293	984	17.4	4.119.00.080080.83NH22.25...

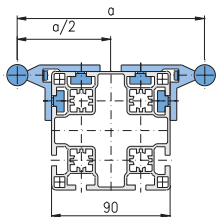

Descr.	Base profile		Shaft		Moment of i.			G	Article-No.	
	Dim.	L1	L2	$\emptyset$	a	Ix	Iy			kg/m
LWF-2	90×90	L	N	H	12	134	294	455	9.7	4.119.00.090090.83LNH22.12...
LWF-2	90×90	L	N	H	16	142	309	585	11.1	4.119.00.090090.83LNH22.16...
LWF-2	90×90	L	N	H	20	154	335	829	17.8	4.119.00.090090.83LNH22.20...
LWF-2	90×90	L	N	H	25	162	346	1,148	16.8	4.119.00.090090.83LNH22.25...

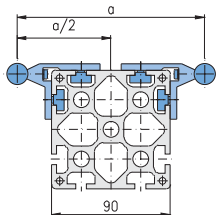

Descr.	Base profile		Shaft		Moment of i.			G	Article-No.	
	Dim.	L1	L2	$\emptyset$	a	Ix	Iy			kg/m
LWF-2	90×90	N	H	H	12	134	408	547	13.9	4.119.00.090090.83NH22.12...
LWF-2	90×90	N	H	H	16	142	430	677	15.3	4.119.00.090090.83NH22.16...
LWF-2	90×90	N	H	H	20	154	468	921	17.8	4.119.00.090090.83NH22.20...
LWF-2	90×90	N	H	H	25	162	488	1,240	21.0	4.119.00.090090.83NH22.25...

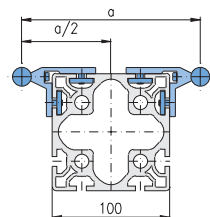

Descr.	Base profile		Shaft		Moment of i.			G	Article-No.	
	Dim.	L1	L2	$\emptyset$	a	Ix	Iy			kg/m
LWF-2	100×100	N	H	H	12	144	558	717	14.1	4.119.00.100100.83NH22.12...
LWF-2	100×100	N	H	H	16	152	583	850	15.5	4.119.00.100100.83NH22.16...
LWF-2	100×100	N	H	H	20	164	635	1,143	18.0	4.119.00.100100.83NH22.20...
LWF-2	100×100	N	H	H	25	172	661	1,501	21.2	4.119.00.100100.83NH22.25...

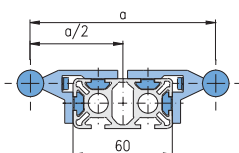

Descr.	Base profile		Shaft		Moment of i.			G	Article-No.	
	Dim.	L1	L2	$\emptyset$	a	Ix	Iy			kg/m
LWF-2	30×60	H	H	H	12	104	17	158	5.9	4.119.00.030060.64HH22.12...
LWF-2	30×60	H	H	H	16	112	18	235	7.3	4.119.00.030060.64HH22.16...

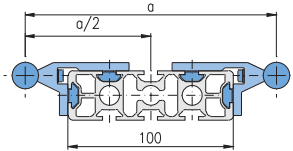

Descr.	Base profile Dim.	Shaft L1	Shaft L2	Shaft Ø	a	Moment of i. G			Article-No.
						lx	ly	kg/m	
LWF-2	30×100	H	H	12	144	24	421	7.5	4.119.00.030100.84HH22.12...
LWF-2	30×100	H	H	16	152	26	554	8.9	4.119.00.030100.84HH22.16...

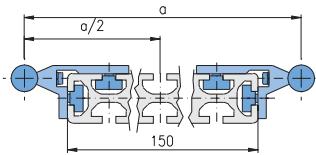

Descr.	Base profile Dim.	Shaft L1	Shaft L2	Shaft Ø	a	Moment of i. G			Article-No.
						lx	ly	kg/m	
LWF-2	30×150	H	H	12	194	40	1,115	12.0	4.119.00.030150.84HH22.12...
LWF-2	30×150	H	H	16	202	42	1,341	13.4	4.119.00.030150.84HH22.16...

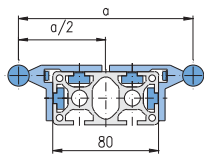

Descr.	Base profile Dim.	Shaft L1	Shaft L2	Shaft Ø	a	Moment of i. G			Article-No.
						lx	ly	kg/m	
LWF-2	40×80	H	H	12	124	47	308	8.2	4.119.00.040080.65HH22.12...
LWF-2	40×80	H	H	16	132	49	420	9.6	4.119.00.040080.65HH22.16...
LWF-2	40×80	H	H	20	144	56	634	12.1	4.119.00.040080.65HH22.20...
LWF-2	40×80	H	H	25	152	58	915	15.3	4.119.00.040080.65HH22.25...

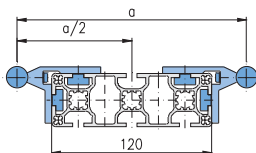

Descr.	Base profile Dim.	Shaft L1	Shaft L2	Shaft Ø	a	Moment of i. G			Article-No.
						lx	ly	kg/m	
LWF-2	40×120 L	H	H	12	164	49	659	8.1	4.119.00.040120.84LHH22.12...
LWF-2	40×120 L	H	H	16	172	52	826	9.5	4.119.00.040120.84LHH22.16...
LWF-2	40×120 L	H	H	20	184	59	1,199	12.0	4.119.00.040120.84LHH22.20...
LWF-2	40×120 L	H	H	25	192	61	1,643	15.2	4.119.00.040120.84LHH22.25...

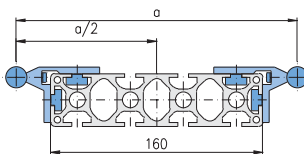

Descr.	Base profile Dim.	Shaft L1	Shaft L2	Shaft Ø	a	Moment of i. G			Article-No.
						lx	ly	kg/m	
LWF-2	40×160 L	H	H	12	204	62	1,263	10.0	4.119.00.040160.104LHH22.12...
LWF-2	40×160 L	H	H	16	212	65	1,510	11.4	4.119.00.040160.104LHH22.16...
LWF-2	40×160 L	H	H	20	224	73	2,070	13.9	4.119.00.040160.104LHH22.20...
LWF-2	40×160 L	H	H	25	232	75	2,716	17.1	4.119.00.040160.104LHH22.25...

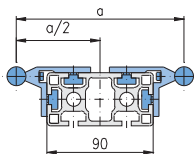

Descr.	Base profile Dim.	Shaft L1	Shaft L2	Shaft Ø	a	Moment of i. G			Article-No.
						lx	ly	kg/m	
LWF-2	45×90	H	H	12	134	63	403	8.8	4.119.00.045090.64HH22.12...
LWF-2	45×90	H	H	16	142	67	532	10.2	4.119.00.045090.64HH22.16...
LWF-2	45×90	H	H	20	154	75	777	12.7	4.119.00.045090.64HH22.20...
LWF-2	45×90	H	H	25	162	77	1,095	15.9	4.119.00.045090.64HH22.25...

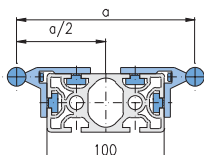

Descr.	Base profile Dim.	Shaft L1	Shaft L2	Shaft Ø	a	Moment of i. G			Article-No.
						lx	ly	kg/m	
LWF-2	50×100	H	H	12	144	93	530	10.3	4.119.00.050100.65HH22.12...
LWF-2	50×100	H	H	16	152	98	663	11.7	4.119.00.050100.65HH22.16...
LWF-2	50×100	H	H	20	164	109	956	14.2	4.119.00.050100.65HH22.20...
LWF-2	50×100	H	H	25	172	112	1,314	17.4	4.119.00.050100.65HH22.25...

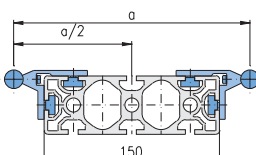

Descr.	Base profile Dim.	Shaft L1	Shaft L2	Shaft Ø	a	Moment of i. G			Article-No.
						lx	ly	kg/m	
LWF-2	50×150	H	H	12	194	122	1,313	12.5	4.119.00.050150.85HH22.12...
LWF-2	50×150	H	H	16	202	129	1,539	13.9	4.119.00.050150.85HH22.16...
LWF-2	50×150	H	H	20	214	141	2,052	16.4	4.119.00.050150.85HH22.20...
LWF-2	50×150	H	H	25	222	144	2,640	19.6	4.119.00.050150.85HH22.25...

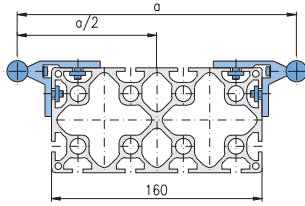

Descr.	Base profile Dim.	Shaft L1	Shaft L2	Shaft Ø	a	Moment of i. G			Article-No.
						$I_x$	$I_y$	kg/m	
LWF-2	80×160 H	H	H	12	204	380	1,688	14.9	4.119.00.080160.124HH22.12...
LWF-2	80×160 H	H	H	16	212	397	1,936	16.3	4.119.00.080160.124HH22.16...
LWF-2	80×160 H	H	H	20	224	430	2,500	18.8	4.119.00.080160.124HH22.20...
LWF-2	80×160 H	H	H	25	232	446	3,142	22.0	4.119.00.080160.124HH22.25...

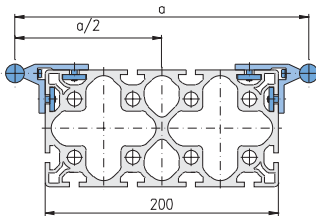

Descr.	Base profile Dim.	Shaft L1	Shaft L2	Shaft Ø	a	Moment of i. G			Article-No.
						$I_x$	$I_y$	kg/m	
LWF-2	100×200 H	H	H	12	244	953	3,717	21.9	4.119.00.100200.124HH22.12...
LWF-2	100×200 H	H	H	16	252	985	4,060	23.3	4.119.00.100200.124HH22.16...
LWF-2	100×200 H	H	H	20	264	1,055	4,858	25.8	4.119.00.100200.124HH22.20...
LWF-2	100×200 H	H	H	25	272	1,096	5,733	29.0	4.119.00.100200.124HH22.25...

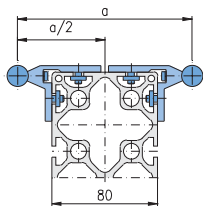

Descr.	Base profile Dim.	Shaft L1	Shaft L2	Shaft Ø	a	Moment of i. G			Article-No.
						$I_x$	$I_y$	kg/m	
LWF-2	80×160 V	H	H	12	124	1,376	496	14.9	4.119.00.080160.124VH22.12...
LWF-2	80×160 V	H	H	16	132	1,441	599	16.3	4.119.00.080160.124VH22.16...
LWF-2	80×160 V	H	H	20	144	1,580	822	18.8	4.119.00.080160.124VH22.20...
LWF-2	80×160 V	H	H	25	152	1,666	1,104	22.0	4.119.00.080160.124VH22.25...

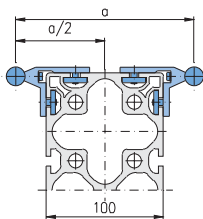

Descr.	Base profile Dim.	Shaft L1	Shaft L2	Shaft Ø	a	Moment of i. G			Article-No.
						$I_x$	$I_y$	kg/m	
LWF-2	100×200 V	H	H	12	144	3,370	1,088	21.9	4.119.00.100200.124VH22.12...
LWF-2	100×200 V	H	H	16	152	3,499	1,221	23.3	4.119.00.100200.124VH22.16...
LWF-2	100×200 V	H	H	20	164	3,799	1,514	25.8	4.119.00.100200.124VH22.20...
LWF-2	100×200 V	H	H	25	172	4,007	1,872	29.0	4.119.00.100200.124VH22.25...

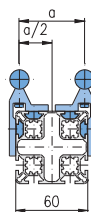

Descr.	Base profile Dim.	Shaft L1	Shaft L2	Shaft Ø	a	Moment of i. G			Article-No.
						$I_x$	$I_y$	kg/m	
LWF-2	60×60 L	N	V	12	52	117	112	6.9	4.119.00.060060.83LNV22.12...
LWF-2	60×60 L	N	V	16	54	152	135	8.3	4.119.00.060060.83LNV22.16...

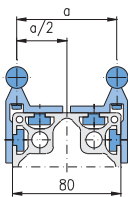

Descr.	Base profile Dim.	Shaft L1	Shaft L2	Shaft Ø	a	Moment of i. G			Article-No.
						$I_x$	$I_y$	kg/m	
LWF-2	80×80 N	V	V	12	72	305	295	10.3	4.119.00.080080.83NV22.12...
LWF-2	80×80 N	V	V	16	74	359	318	11.7	4.119.00.080080.83NV22.16...
LWF-2	80×80 N	V	V	20	72	476	387	14.2	4.119.00.080080.83NV22.20...
LWF-2	80×80 N	V	V	25	68	601	431	17.4	4.119.00.080080.83NV22.25...

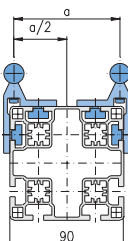

Descr.	Base profile Dim.	Shaft L1	Shaft L2	Shaft Ø	a	Moment of i. G			Article-No.
						$I_x$	$I_y$	kg/m	
LWF-2	90×90 L	N	V	12	82	356	364	9.7	4.119.00.090090.83LNV22.12...
LWF-2	90×90 L	N	V	16	84	424	405	11.1	4.119.00.090090.83LNV22.16...
LWF-2	90×90 L	N	V	20	82	533	484	13.6	4.119.00.090090.83LNV22.20...
LWF-2	90×90 L	N	V	25	78	659	542	16.8	4.119.00.090090.83LNV22.25...

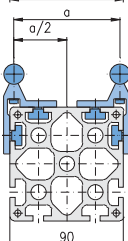

Descr.	Base profile Dim.	Shaft L1	Shaft L2	Shaft Ø	a	Moment of i. G			Article-No.
						$I_x$	$I_y$	kg/m	
LWF-2	90×90 N	V	V	12	82	480	456	13.9	4.119.00.090090.83NV22.12...
LWF-2	90×90 N	V	V	16	84	565	496	15.3	4.119.00.090090.83NV22.16...
LWF-2	90×90 N	V	V	20	82	708	575	17.8	4.119.00.090090.83NV22.20...
LWF-2	90×90 N	V	V	25	78	876	634	21.0	4.119.00.090090.83NV22.25...

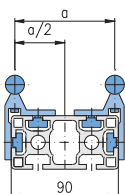
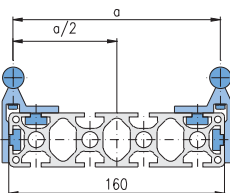
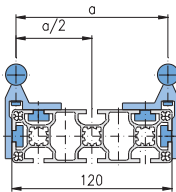
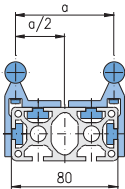
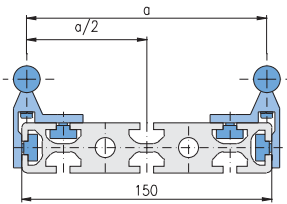
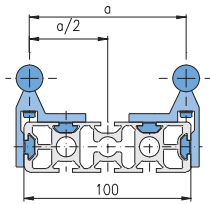
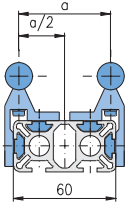
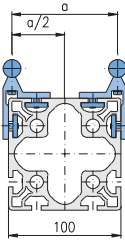

Descr.	Base profile Dim.	Shaft L1	Shaft L2	Shaft Ø	a	Moment of i. G			Article-No.
						lx	ly	kg/m	
LWF-2	100×100 N	V	12	92	92	637	617	14.1	4.119.00.100100.83NV22.12...
LWF-2	100×100 N	V	16	94	94	727	661	15.5	4.119.00.100100.83NV22.16...
LWF-2	100×100 N	V	20	92	92	897	767	18.0	4.119.00.100100.83NV22.20...
LWF-2	100×100 N	V	25	88	88	1,087	842	21.2	4.119.00.100100.83NV22.25...

Descr.	Base profile Dim.	Shaft L1	Shaft L2	Shaft Ø	a	Moment of i. G			Article-No.
						lx	ly	kg/m	
LWF-2	30×60 H	V	12	52	52	40	94	5.9	4.119.00.030060.64HV22.12...
LWF-2	30×60 H	V	16	54	54	61	109	7.3	4.119.00.030060.64HV22.16...

Descr.	Base profile Dim.	Shaft L1	Shaft L2	Shaft Ø	a	Moment of i. G			Article-No.
						lx	ly	kg/m	
LWF-2	30×100 H	V	12	92	92	50	321	7.5	4.119.00.030100.84HV22.12...
LWF-2	30×100 H	V	16	94	94	75	37	8.9	4.119.00.030100.84HV22.16...

Descr.	Base profile Dim.	Shaft L1	Shaft L2	Shaft Ø	a	Moment of i. G			Article-No.
						lx	ly	kg/m	
LWF-2	30×150 H	V	12	142	142	71	971	12.0	4.119.00.030150.84HV22.12...
LWF-2	30×150 H	V	16	144	144	102	1,072	13.4	4.119.00.030150.84HV22.16...

Descr.	Base profile Dim.	Shaft L1	Shaft L2	Shaft Ø	a	Moment of i. G			Article-No.
						lx	ly	kg/m	
LWF-2	40×80 H	V	12	72	72	80	225	8.2	4.119.00.040080.65HV22.12...
LWF-2	40×80 H	V	16	74	74	110	253	9.6	4.119.00.040080.65HV22.16...
LWF-2	40×80 H	V	20	72	72	168	318	12.1	4.119.00.040080.65HV22.20...
LWF-2	40×80 H	V	25	68	68	234	362	15.3	4.119.00.040080.65HV22.25...

Descr.	Base profile Dim.	Shaft L1	Shaft L2	Shaft Ø	a	Moment of i. G			Article-No.
						lx	ly	kg/m	
LWF-2	40×120 L H	V	12	112	112	82	82	8.1	4.119.00.040120.84LHV22.12...
LWF-2	40×120 L H	V	16	114	114	113	606	9.5	4.119.00.040120.84LHV22.16...
LWF-2	40×120 L H	V	20	112	112	170	762	12.0	4.119.00.040120.84LHV22.20...
LWF-2	40×120 L H	V	25	108	108	237	879	15.2	4.119.00.040120.84LHV22.25...

Descr.	Base profile Dim.	Shaft L1	Shaft L2	Shaft Ø	a	Moment of i. G			Article-No.
						lx	ly	kg/m	
LWF-2	40×160 L H	V	12	152	152	98	1,111	10.0	4.119.00.040160.104LHV22.12...
LWF-2	40×160 L H	V	16	154	154	133	1,225	11.4	4.119.00.040160.104LHV22.16...
LWF-2	40×160 L H	V	20	152	152	198	1,515	13.9	4.119.00.040160.104LHV22.20...
LWF-2	40×160 L H	V	25	148	148	277	1,742	17.1	4.119.00.040160.104LHV22.25...

Descr.	Base profile Dim.	Shaft L1	Shaft L2	Shaft Ø	a	Moment of i. G			Article-No.
						lx	ly	kg/m	
LWF-2	45×90 H	V	12	82	82	100	312	8.8	4.119.00.045090.64HV22.12...
LWF-2	45×90 H	V	16	84	84	135	347	10.2	4.119.00.045090.64HV22.16...
LWF-2	45×90 H	V	20	82	82	200	431	12.7	4.119.00.045090.64HV22.20...
LWF-2	45×90 H	V	25	78	78	276	489	15.9	4.119.00.045090.64HV22.25...

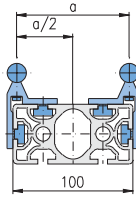

Descr.	Base profile Dim.	Shaft L1	Shaft L2	Shaft Ø	a	Moment of i. G			Article-No.
						lx	ly	kg/m	
LWF-2	50×100 H	V	12	92	135	430	10.3	4.119.00.050100.65HV22.12...	
LWF-2	50×100 H	V	16	94	176	474	11.7	4.119.00.050100.65HV22.16...	
LWF-2	50×100 H	V	20	92	252	580	14.2	4.119.00.050100.65HV22.20...	
LWF-2	50×100 H	V	25	88	341	655	17.4	4.119.00.050100.65HV22.25...	

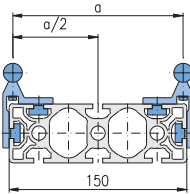

Descr.	Base profile Dim.	Shaft L1	Shaft L2	Shaft Ø	a	Moment of i. G			Article-No.
						lx	ly	kg/m	
LWF-2	50×150 H	V	12	142	167	1,170	12.5	4.119.00.050150.85HV22.12...	
LWF-2	50×150 H	V	16	144	213	1,270	13.9	4.119.00.050150.85HV22.16...	
LWF-2	50×150 H	V	20	142	298	1,523	16.4	4.119.00.050150.85HV22.20...	
LWF-2	50×150 H	V	25	138	400	1,719	19.6	4.119.00.050150.85HV22.25...	

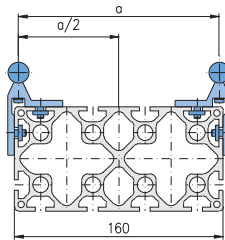

Descr.	Base profile Dim.	Shaft L1	Shaft L2	Shaft Ø	a	Moment of i. G			Article-No.
						lx	ly	kg/m	
LWF-2	80×160 H	V	12	152	446	1,536	14.9	4.119.00.080160.124HV22.12...	
LWF-2	80×160 H	V	16	154	519	1,651	16.3	4.119.00.080160.124HV22.16...	
LWF-2	80×160 H	V	20	152	656	1,941	18.8	4.119.00.080160.124HV22.20...	
LWF-2	80×160 H	V	25	148	814	2,168	22.0	4.119.00.080160.124HV22.25...	

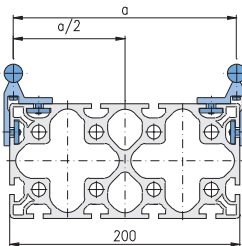

Descr.	Base profile Dim.	Shaft L1	Shaft L2	Shaft Ø	a	Moment of i. G			Article-No.
						lx	ly	kg/m	
LWF-2	100×200 H	V	12	192	1,040	3,530	21.9	4.119.00.100200.124HV22.12...	
LWF-2	100×200 H	V	16	194	1,147	3,711	23.3	4.119.00.100200.124HV22.16...	
LWF-2	100×200 H	V	20	192	1,359	4,176	25.8	4.119.00.100200.124HV22.20...	
LWF-2	100×200 H	V	25	188	1,603	4,550	29.0	4.119.00.100200.124HV22.25...	

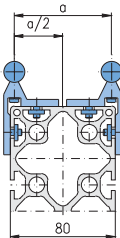

Descr.	Base profile Dim.	Shaft L1	Shaft L2	Shaft Ø	a	Moment of i. G			Article-No.
						lx	ly	kg/m	
LWF-2	80×160 V	V	12	72	1,494	414	14.9	4.119.00.080160.124V22.12...	
LWF-2	80×160 V	V	16	74	1,655	442	16.3	4.119.00.080160.124V22.16...	
LWF-2	80×160 V	V	20	72	1,966	507	18.8	4.119.00.080160.124V22.20...	
LWF-2	80×160 V	V	25	68	2,295	550	22.0	4.119.00.080160.124V22.25...	

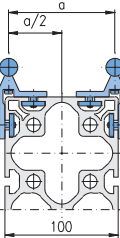

Descr.	Base profile Dim.	Shaft L1	Shaft L2	Shaft Ø	a	Moment of i. G			Article-No.
						lx	ly	kg/m	
LWF-2	100×200 V	V	12	92	3,531	988	21.9	4.119.00.100200.124V22.12...	
LWF-2	100×200 V	V	16	94	3,792	1,032	23.3	4.119.00.100200.124V22.16...	
LWF-2	100×200 V	V	20	92	4,340	1,138	25.8	4.119.00.100200.124V22.20...	
LWF-2	100×200 V	V	25	88	4,901	1,213	29.0	4.119.00.100200.124V22.25...	

for shaft-Ø12

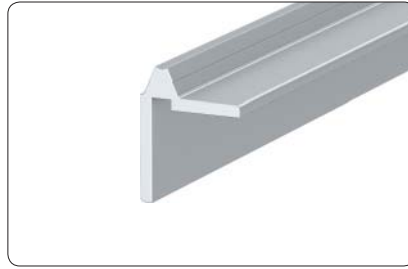

**Technical data**

material: Al Mg Si 0,5 F 25  
 surface: neutral anodised  
 length: 6 m  
 height and side tolerance:  
 • to specified length: ± 0.2 mm  
 • within one bar: 0.1 mm

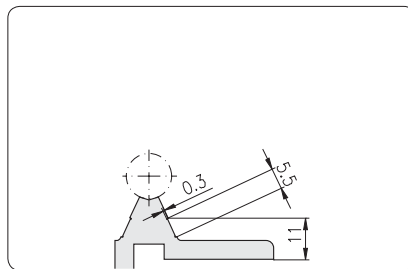
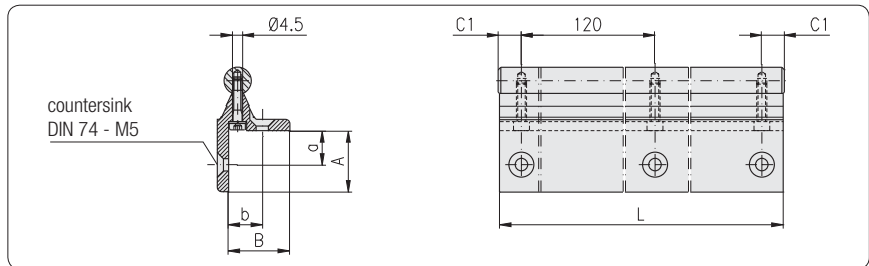

**Calculation of C1:**

$$C1 = 1/2 \cdot (L - n \cdot 120)$$

n = maximum number of divisions

Cut to length: 4.119.0□.12.□□□□□□□□-02/... (/... = length in mm)

**Type A**

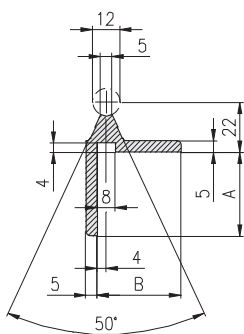

Moment of inertia	cm <sup>4</sup>	Ix = 8.5	Iy = 6.6
Moment of resistance	cm <sup>3</sup>	Wx = 2.6	Wy = 2.2
Weight (G)	kg/m		

Description	A	a	B	b	G	Article-No.
Shaft guidance profile 12A	37	-	37	-	1.30	4.119.0A.12.37003700.60
Shaft guidance profile 12A	27	15.0	27	15.0	1.03	4.119.0A.12.27152715.60
Shaft guidance profile 12A	27	15.0	37	15.0	1.17	4.119.0A.12.27153715.60
Shaft guidance profile 12A	27	15.0	37	25.0	1.17	4.119.0A.12.27153725.60
Shaft guidance profile 12A	37	20.0	37	20.0	1.30	4.119.0A.12.37203720.60
Shaft guidance profile 12A	37	22.5	37	22.5	1.30	4.119.0A.12.37223722.60
Shaft guidance profile 12A	37	25.0	27	15.0	1.17	4.119.0A.12.37252715.60
Shaft guidance profile 12A	37	25.0	37	25.0	1.30	4.119.0A.12.37253725.60



for shaft-Ø16

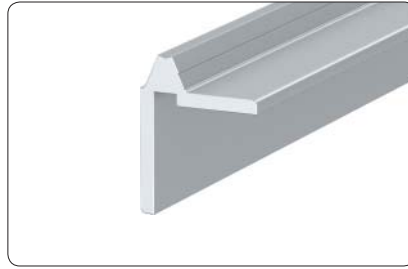

**Technical data**

material: Al Mg Si 0,5 F 25  
 surface: neutral anodised  
 length: 6 m  
 height and side tolerance:  
 • to specified length: ± 0.2 mm  
 • within one bar: 0.1 mm

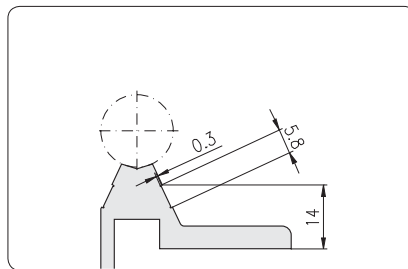
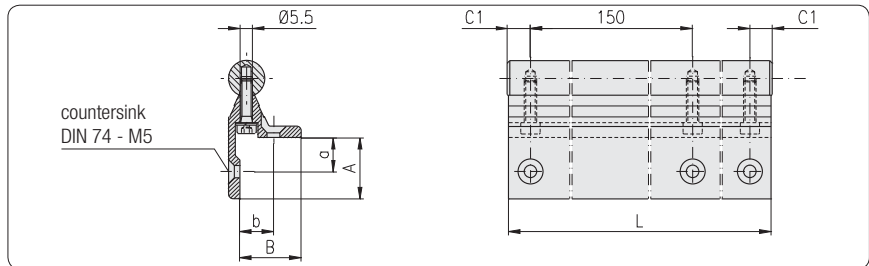

**Calculation of C1:**

$C1 = 1/2 \cdot (L - n \cdot 150)$   
 n = maximum number of divisions

Cut to length: 4.119.0□.16.□□□□□□□□-02/... (/... = length in mm)

**Type A**

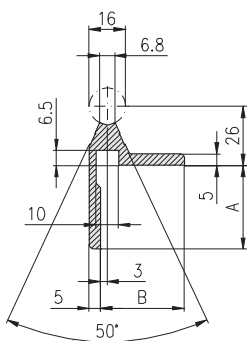

Moment of inertia	cm <sup>4</sup>	Ix = 10.1	Iy = 6.6
Moment of resistance	cm <sup>3</sup>	Wx = 3.0	Wy = 2.2
Weight (G)	kg/m		

Description	A	a	B	b	G	Article-No.
Shaft guidance profile 16A	37	-	37	-	1.30	4.119.0A.16.37003700.60
Shaft guidance profile 16A	27	15.0	27	15.0	1.03	4.119.0A.16.27152715.60
Shaft guidance profile 16A	27	15.0	37	15.0	1.17	4.119.0A.16.27153715.60
Shaft guidance profile 16A	27	15.0	37	25.0	1.17	4.119.0A.16.27153725.60
Shaft guidance profile 16A	37	15.0	27	15.0	1.17	4.119.0A.16.37152715.60
Shaft guidance profile 16A	37	20.0	37	20.0	1.30	4.119.0A.16.37203720.60
Shaft guidance profile 16A	37	22.5	37	22.5	1.30	4.119.0A.16.37223722.60
Shaft guidance profile 16A	37	25.0	27	15.0	1.17	4.119.0A.16.37252715.60
Shaft guidance profile 16A	37	25.0	37	25.0	1.30	4.119.0A.16.37253725.60

for shaft-Ø20

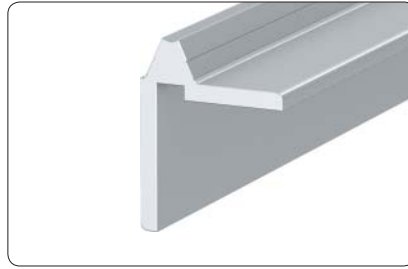

**Technical data**

material: Al Mg Si 0,5 F 25  
 surface: neutral anodised  
 length: 6 m  
 height and side tolerance:  
 • to specified length: ± 0.2 mm  
 • within one bar: 0.1 mm

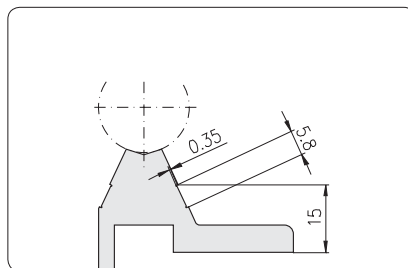
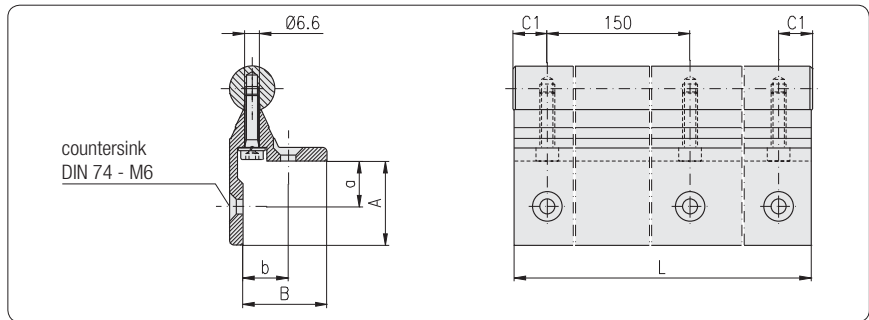

**Calculation of C1:**

$C1 = 1/2 \cdot (L - n \cdot 150)$

n = maximum number of divisions

Cut to length: 4.119.0□.20.□□□□□□□□-02/... (/... = length in mm)

**Type A**

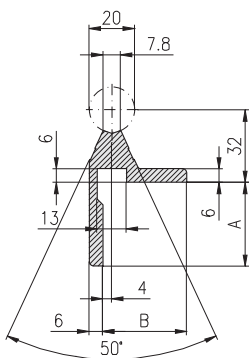

Moment of inertia	cm <sup>4</sup>	I <sub>x</sub> = 14.6	I <sub>y</sub> = 8.4
Moment of resistance	cm <sup>3</sup>	W <sub>x</sub> = 4.0	W <sub>y</sub> = 2.8
Weight (G)	kg/m		

Description	A	a	B	b	G	Article-No.
Shaft guidance profile 20A	37	-	37	-	1.7	4.119.0A.20.37003700.60
Shaft guidance profile 20A	37	20.0	37	20.0	1.7	4.119.0A.20.37203720.60
Shaft guidance profile 20A	37	22.5	37	22.5	1.7	4.119.0A.20.37223722.60
Shaft guidance profile 20A	37	25.0	37	25.0	1.7	4.119.0A.20.37253725.60

for shaft-Ø25

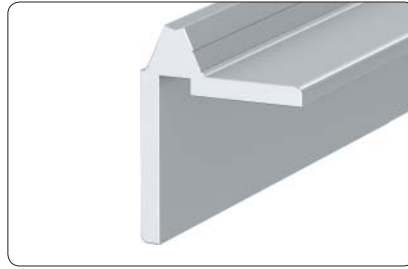

**Technical data**

material: Al Mg Si 0,5 F 25  
 surface: neutral anodised  
 length: 6 m  
 height and side tolerance:  
 • to specified length: ± 0.2 mm  
 • within one bar: 0.1 mm

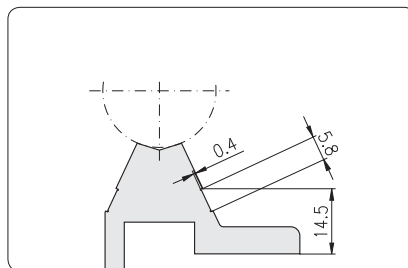
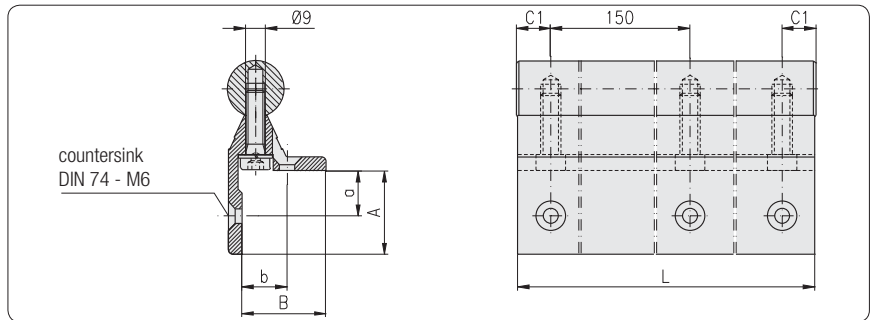

**Calculation of C1:**

$C1 = 1/2 \cdot (L - n \cdot 150)$

n = maximum number of divisions

Cut to length: 4.119.0□.25.□□□□□□□□-02/... (/... = length in mm)

**Type A**

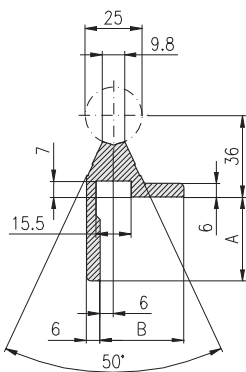

Moment of inertia	cm <sup>4</sup>	Ix = 16.6	Iy = 8.7
Moment of resistance	cm <sup>3</sup>	Wx = 4.4	Wy = 2.9
Weight (G)	kg/m		

Description	A	a	B	b	G	Article-No.
Shaft guidance profile 25A	37	-	37	-	1.9	4.119.0A.25.37003700.60
Shaft guidance profile 25A	37	20.0	37	20.0	1.9	4.119.0A.25.37203720.60
Shaft guidance profile 25A	37	22.5	37	22.5	1.9	4.119.0A.25.37223722.60
Shaft guidance profile 25A	37	25.0	37	25.0	1.9	4.119.0A.25.37253725.60

Shafts

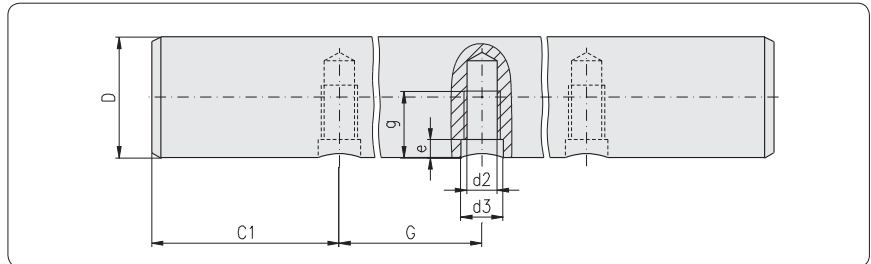

D	d1	d2	d3	g	e	C <sub>1 min</sub> <sup>1)</sup>	G	
12 mm	M5	M4	5	8	2.0	10	120	<sup>1)</sup> For applications with axial thread C1 has to be adapted for the drilling depth of the axial thread ↳ 48
16 mm	M6	M5	6	9	2.5	10	150	
20 mm	M8	M6	7	11	3.0	10	150	
25 mm	M10	M8	9	15	3.0	15	150	

Calculation of C1:

$$C1 = 1/2 \cdot (L - n \cdot G)$$

n = maximum number of divisions

Coated steel

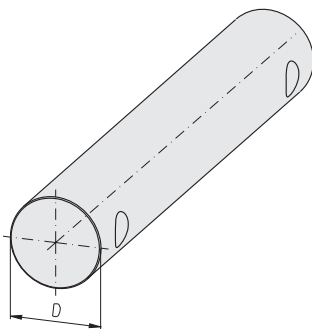

Technical data

material: coated steel  
 surface: edge layer hardened, polished  
 coat hardness: 670 + 170HV (59 + 6HRC)  
 length of bar: 6 m, ends unchamfered  
 weight (G): kg/m

Description	D	Roundness	Parallelism	G	Article-No.
Shaft	12 h6	5 µm	8 µm	0.89	4.119.0W.21.12.60
Shaft	16 h6	5 µm	8 µm	1.57	4.119.0W.21.16.60
Shaft	20 h6	6 µm	9 µm	2.45	4.119.0W.21.20.60
Shaft	25 h6	6 µm	9 µm	3.83	4.119.0W.21.25.60

Noncorroding steel  
X46Cr13

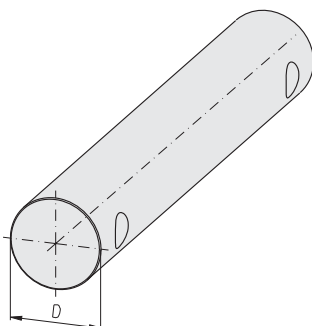



Technical data

material: X46Cr13  
 surface: polished  
 coat hardness: 560 + 60HV (54 + 3HRC)  
 length of bar: 6 m, ends unchamfered  
 weight (G): kg/m

Description	D	Roundness	Parallelism	G	Article-No.
Shaft X46Cr13	12 h6	5 µm	8 µm	0.89	4.119.0W.22.12.60
Shaft X46Cr13	16 h6	5 µm	8 µm	1.57	4.119.0W.22.16.60
Shaft X46Cr13	20 h6	6 µm	9 µm	2.45	4.119.0W.22.20.60
Shaft X46Cr13	25 h6	6 µm	9 µm	3.83	4.119.0W.22.25.60

Machining of shafts

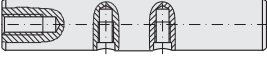
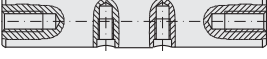
Description	
	Machining of shaft - 1 axial thread
	Machining of shaft - 2 axial threads
	Machining of shaft - 1 axial and radial thread
	Machining of shaft - 2 axial and radial threads

Dimensions for machining of shafts

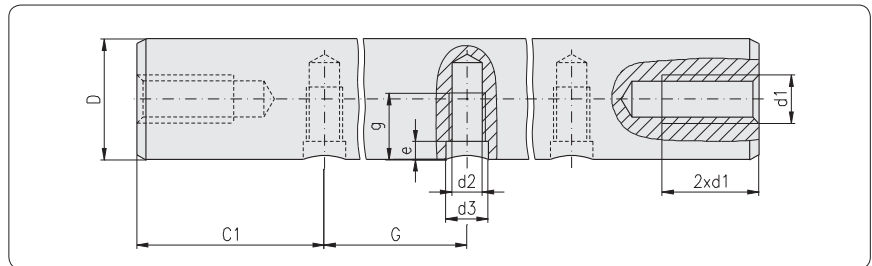

D	d1	d2	d3	g	e	C <sub>1 min</sub> <sup>1)</sup>	G	
12 mm	M5	M4	5	8	2.0	10	120	1) For applications with axial thread C1 has to be adapted for the drilling depth of the axial thread
16 mm	M6	M5	6	9	2.5	10	150	
20 mm	M8	M6	7	11	3.0	10	150	
25 mm	M10	M8	9	15	3.0	15	150	

Calculation of C1:

$$C1 = 1/2 \cdot (L - n \cdot G)$$

n = maximum number of divisions

Straightness tolerance for shafts cut to length

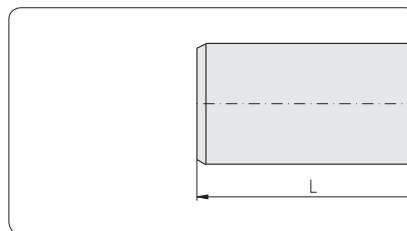

Length	Tolerance
0 - 400	± 0.5
400 - 1,000	± 0.8
1,000 - 2,000	± 1.2
2,000 - 4,000	± 2.0
4,000 - 6,000	± 3.0

Chamfer on a shaft side

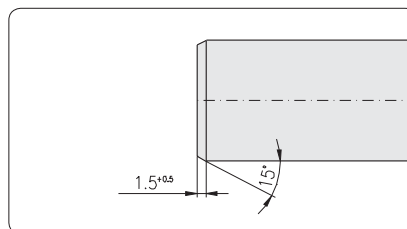

**Order example**  
 for shafts

bar 6m	4.119.0W.11.12.60		
cut to length	4.119.0W.11.12-□□□□□□/□□□□		
	4.119.0W.11.12- S □□□□□□/□□□□	left	cut
	4.119.0W.11.12- F □□□□□□/□□□□	left	chamfer
	4.119.0W.11.12- A □□□□□□/□□□□	left	axial thread
	4.119.0W.11.12- □□□ S □□□□□□/□□□□	right	cut
	4.119.0W.11.12- □□□□ F □□□□□□/□□□□	right	chamfer
	4.119.0W.11.12- □□□□□□ A /□□□□	right	axial thread
	4.119.0W.11.12- □□□□□□□□/□□□□		length in mm

**Imprint**

Subject to technical modification.  
 All rights reserved.  
 Copying - also in parts - only allowed by  
 written consent.  
 © MayTec Aluminium Systemtechnik GmbH,  
 Germany, 85221 Dachau, 2018



MayTec GmbH plant in Olching



Small parts storage

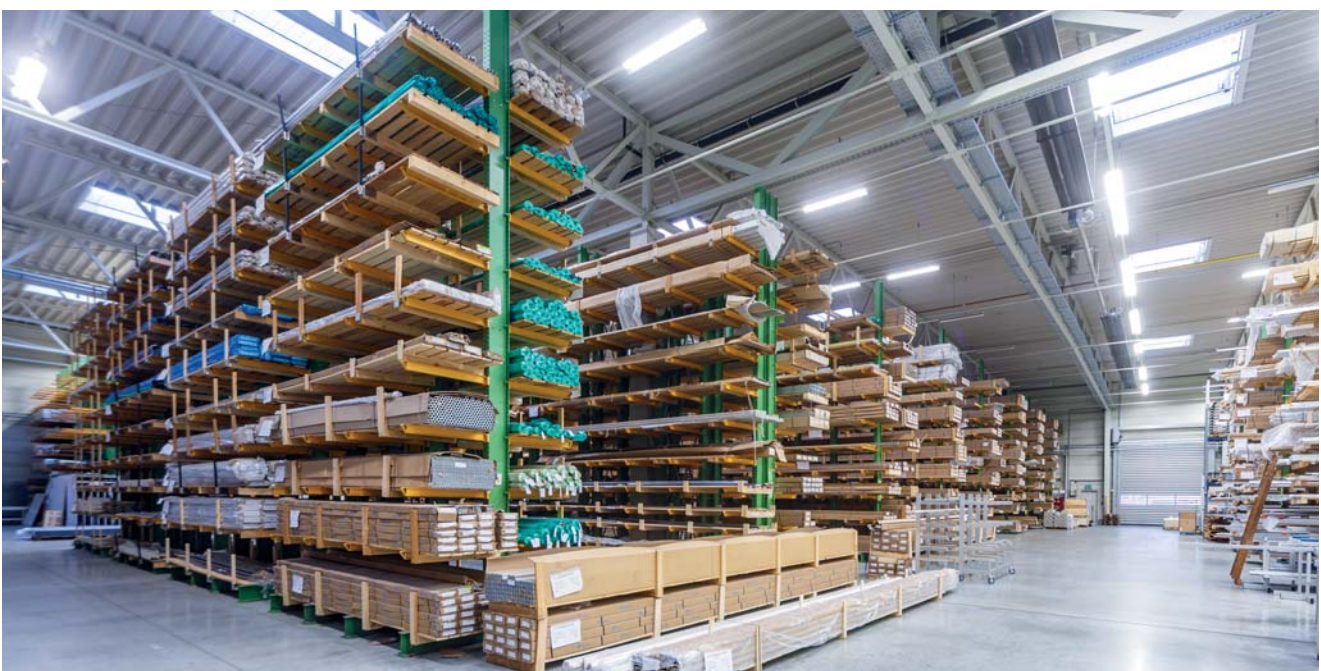

Stock of aluminium profiles

The key ...

to success

extremely strong

efficient

functional

**New address from 2019**

**MayTec Aluminium**  
Systemtechnik GmbH  
Gewerbering 16  
D-82140 Olching

**Australia**

**MayTec Australia P/L**  
Unit 8, 175 James Ruse Drive  
Rosehill, NSW 2142

country code: +61  
phone (0)2/98989929  
fax (0)2/96384086  
e-mail: [info@maytec.com.au](mailto:info@maytec.com.au)  
<http://www.maytec.com.au>

**Germany**

**MayTec Aluminium**  
Systemtechnik GmbH  
Kopernikusstraße 20  
D-85221 Dachau

country code: +49  
phone (0)8131/3336-0  
fax (0)8131/3336-119  
e-mail: [mail@maytec.de](mailto:mail@maytec.de)  
<http://www.maytec.de>

**USA**

**MayTec Inc.**  
901 Wesemann Drive  
West Dundee, IL 60118

country code: +1  
phone 847-429-0321  
fax 847-429-0460  
e-mail: [mail@maytecinc.com](mailto:mail@maytecinc.com)  
<http://www.maytecinc.com>

**MayTec distributor**