

高性能塑料关节轴承 High polymer-tech for plastic spherical bearings



产品特性 Product features

- 自润滑、免维护
- 耐腐蚀，可用于液体介质环境
- 抵抗灰尘和污垢
- 无噪音运行
- 承受边缘载荷
- 重量轻、节约空间
- 易安装、成本低
- Maintenance-free dry operation
- Absolute corrosion resistance, media resistant
- Dirt-resistant and no noise
- Compensation of misalignment errors
- Compensation of edge loads
- Light weight and space saving
- Easy installation and low cost

CSB-BAL® 球体 Spherical balls

标准球体采用高耐磨EPB15材料制成，它在干运行时具有较高的承载和极低的摩擦系数，特别适用于高载低速运动场合。CSB还可以采取其它标准耐磨材料制成球体，从而提高关节轴承的特殊使用性能。

In standard spherical ball is made from EPB15 material, which is known for its high strength and low coefficient of friction while running dry. This is especially important for low loads and very slow movements. Further to the standard material EPB15, spherical balls are now available in other materials presenting particular advantages.

CSB-BAL® 基座 Housings

标准基座采用高强度M163材料制成，它是纤维增强聚合物材料，具有较好的抗冲击性能，使用温度-30℃至+80℃。CSB还可以采取其它材料制成基座，比如镁铝合金和不锈钢材料等，请联系我们。

Standard housings made from M163, a long-fiber reinforced and extremely shock resistant polymer. Operation temperatures from -30°C to +80°C, It is available other materials for the housing such as aluminum alloy and stainless steel, please ask us for other materials.

载荷和温度 Loads and temperatures

在正常外界温度使用的情况下，塑料关节轴承具有较高的承载能力，尽管其重量只有金属关节轴承的1/5；塑料关节轴承由于球体和基座均采用特种塑料制成具有一定的减震性能。塑料关节轴承长期用于高载或极端温度下时我们建议通过实际实验检测。

The load capacity of the maintenance-free spherical bearing is very high at normal ambient temperatures. The weight only one fifth of metal bearing. The excellent dampening properties are based on the fact that the polymer material of the two part bearing can absorb vibrations differently than steel. The load capacity of the rod end should therefore be checked in a practical test, particularly if it will be used under continuous high loads and at elevated temperatures.

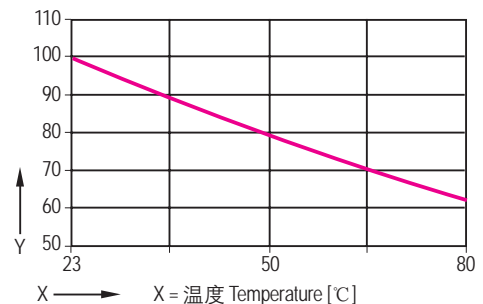

Y = 抗拉强度百分比 Percentage tensile strength [%]
 温度对塑料关节轴承的最大抗拉强度的影响
 Trends indicate the effect of temperature on the max. load capacity of CSB-BAL® bearings

摩擦系数和速度 Coefficient of sliding friction and speed

CSB-BAL® 塑料关节轴承在正常使用时是轴在球体内滑动，球体与基座之间调整角度时存在一定的滑动；球体材料采用EPB15制成具有极低的摩擦系数，在载荷较低时轴与球体之间可达到较高的运动速度。

The shaft sliding in the spherical ball of the spherical bearing in normal operation, There is slightly sliding between the ball and the housing; The spherical ball made from EPB15, Lower friction and permits high speeds, even when running dry.

化学抗性与吸水性 Chemical resistance and water absorption

CSB-BAL® 标准塑料关节轴承完全由聚合物制成，可以抵抗弱酸和弱碱，以及燃油和各类润滑剂。吸水性与材料相关，标准材料在标准大气压下，塑料关节轴承的吸水率为1.3%，浸泡水中饱和吸水率为6.5%。如需要更低吸水率塑料关节轴承，请联系我们。

CSB-BAL® spherical bearings made from polymer are resistant to weak alkalines, weak acids and fuels, as well as all types of lubricants. The moisture absorption of CSB-BAL is approximately 1.3% weight in standard atmosphere. The saturation limit in water is 6.5%. This must be taken into evaluation for applications. Please ask us if you need a special material for lower moisture absorption.

抗辐射与UV性能 Radiation and UV resistance

CSB-BAL® 标准塑料关节可以在户外使用，并具有良好的耐腐蚀性能。标准塑料关节轴承对紫外线具有永久抗性。在紫外线的辐射下，球体的颜色会稍有变化但不会影响它的机械性能、导电性能和热性能。

The corrosion resistance of CSB-BAL® bearings gives them special value for outside applications. CSB-BAL bearings are permanently resistant to UV radiation. A small change in color of the spherical ball due to UV radiation does not affect the mechanical, electrical or thermal properties.

公差与检测 Tolerance

CSB-BAL® 标准塑料关节球体内径公差采用E10标准，轴公差为h6至h9之间。内径检测采用塞规检测而不可以采用游标卡尺检测。如您需要更高精度或其它公差的轴承请联系我们。

The bore of CSB-BAL® spherical ball is produced to a standard tolerance range E10. Shafts should also meet recommended tolerances h6 and h9. The inner diameter with plug gauge to check but not caliper. Please contact us in case you require lower or other bearing tolerances.



正确：采用塞规检测
Tolerance test with plug gauge



错误：采用卡尺检测
Wrong test equipment; caliper

介质 Medium	抗性 Resistance
酒精 Alcohol	+ to 0
烃 Hydrocarbons	+
脂肪、油、无添加剂 Greases, oils without additives	+
辛烷 Fuels	+
弱酸 Diluted acids	0 to -
强酸 Strong acids	-
弱碱 Diluted alkalines	+
强碱 Strong alkalines	0

BAL标准塑料球体 BAL standard plastic balls



产品特性 Product features

- 关节调心场合解决方案。极好的耐磨材料EPB15、EPB13等让BAL系列关节轴承球体性能得以充分展现。同样可提供EPB5耐高温和抗腐蚀材料的球体和EPB20水下应用的球体
- 免维护、自润滑
- 耐腐蚀
- 耐冲击、无噪音
- 重量轻
- The spherical self-aligning solution. The material EPB15 and EPB13 ensures the outstanding advantages of the BAL series plastic balls to be perfect. The high temperature and erosion resistance material EPB5 and in water application material EPB20 are also available
- Self lubricated and maintenance free
- Corrosion resistance
- Impact resistance, low noise
- Light Weight

BAL

CSB-BAL®

www.csb-ep.com
sales@csb-ep.com

Tel: 0086 573 84186133/84185527
Fax: 0086 573 84185517

标准规格 Standard specifications

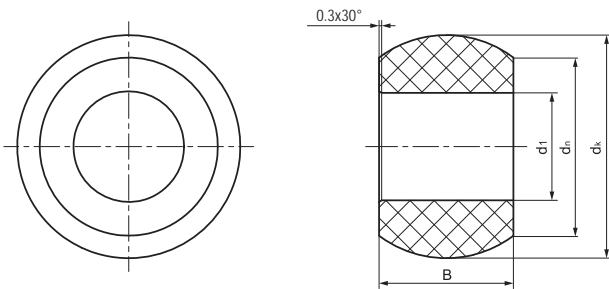

产品编码 Part No.:

BAL-04-05

└─ 宽度 Width

└─ 内径 Inner diameter

产品编码 Part No.	d ₁ E10 [mm]	d _n [mm]	d _k [mm]	B [mm]	重量 Weight [g]
BAL-04-05	4	6.25	8.3	5	0.2
BAL-05-06	5	8	10.3	6	0.3
BAL-06-06	6	8	10.3	6	0.4
BAL-08-08	8	10	13.3	8	0.7
BAL-10-09	10	13	16.1	9	1.2
BAL-12-10	12	15	18.1	10	1.5
BAL-15-12	15	18	22	12	2.4
BAL-16-13	16	19.5	24.1	13	3.3
BAL-20-16	20	24	29.1	16	5.3
BAL-25-20	25	29	35.6	20	9.5
BAL-30-22	30	34	40.9	22	12.1

*根据要求提供特殊材料球体 Special material balls upon request

GLB塑料角支轴承 Plastic spherical bearings



产品特性 Product features

- 外壳采用高强度工程塑料M163制成，内部安装BAL标准自润滑球体
 - 免维护、自润滑
 - 自动补偿安装偏差
 - 耐冲击、无噪音
 - 耐灰尘、重量轻
- The housing is made of high strength plastic M163, with standard BAL self-lubricated balls
 - Maintenance free and self-lubricated
 - Self-compensation for the installation deviation
 - Impact resistance and silent operation
 - Dust resistance with light weight

标准规格 Standard specifications

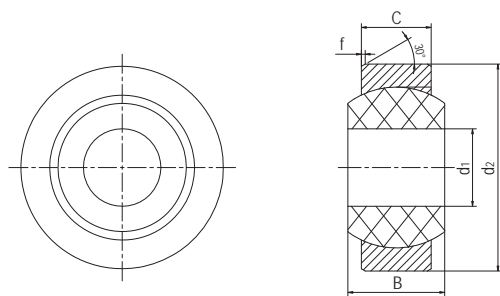

产品编码 Part No.:

GLB-04

内径 Inner diameter

产品编码 Part No.	d ₁ E10 [mm]	d ₂ [mm]	B [mm]	C [mm]	f [mm]	最大调整角度 Max. adjust angle	最大静载荷 [N] Max. static load		重量 Weight [g] Plastic
							径向Radial	轴向Axle	
GLB-04	4	12	5	3	0.3	37°	600	50	0.4
GLB-05	5	14	6	4	0.3	33°	1000	130	0.8
GLB-06	6	14	6	4	0.3	27°	1200	150	0.9
GLB-08	8	16	8	5	0.3	24°	1800	175	1.2
GLB-10	10	19	9	6	0.5	24°	2500	400	1.9
GLB-12	12	22	10	7	0.5	21°	3800	650	2.8
GLB-15	15	26	12	9	0.5	21°	5500	1000	6.9
GLB-16	16	28	13	9.5	0.5	21°	6000	1150	9.0
GLB-20	20	35	16	12	0.8	18°	9000	1400	16.3
GLB-25	25	42	20	16	0.8	16°	14000	2900	29
GLB-30	30	47	22	18	0.8	13°	17000	4000	37.4

*Al: 铝制外壳根据要求 Aluminum housing upon request

GFB法兰关节轴承 Flange spherical bearings



产品特性 Product features

- 球体采用高耐磨材料EPB15制成
 - 保持器采用抗压和尺寸稳定性材料M163制成
 - 干运行、免维护
 - 抵抗灰尘和污垢
 - 补偿中心误差
 - 耐腐蚀，可用于液体介质环境
 - 重量轻、易安装
- Spherical ball made of highly wear-resistant EPB15
 - Housing made of high strength and shape-stable M163
 - Maintenance-free dry operation
 - Resistant to dust and dirt
 - Compensation of misalignment errors
 - Absolute corrosion resistance
 - Very light, easy installation

标准规格 Standard specifications

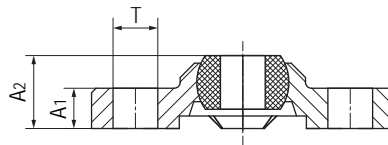
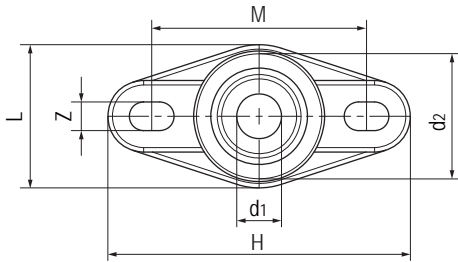

产品编码 Part No.:

GFB-04

内径 Inner diameter

产品编码 Part No.	d ₁ E10 [mm]	d ₂ [mm]	A ₁ [mm]	A ₂ [mm]	T [mm]	L [mm]	H [mm]	Z [mm]	M [mm]	最大轴向静载荷 Max. axial static load		最大径向静负荷 Max. radial static load		最大静态转 矩-孔 Max. tight-ning torque -Holes [Nm]	最大调节 角度 Max. adjust angle	重量 Weight [g]
										短期 Sort-term [N]	长期 Long-term [N]	短期 Sort-term [N]	长期 Long-term [N]			
GFB-04	4	14	4.5	8	5	16	33.8	3.2	24	400	200	750	375	0.6	28°	1.9
GFB-05	5	14	4.5	8.5	5	16	33.8	3.2	24	400	200	750	375	0.6	29°	2.3
GFB-06	6	14	4.5	8.5	5	16	33.8	3.2	24	500	250	800	400	0.6	25°	1.8
GFB-08	8	18	5.5	10.5	6.5	22	44.2	4.3	31	700	350	1100	550	1.3	25°	4.1
GFB-10	10	22	6.5	12	8	26	52	5.3	36	850	425	2000	1000	2.5	25°	6.8
GFB-12	12	25	7	13	8	31	56.7	5.3	41	1100	550	2200	1100	2.5	21°	8.9
GFB-15	15	29.8	8.5	15.5	10	36	68.6	6.4	50	1300	650	2400	1200	4.5	20°	15
GFB-16	16	32	10	17.5	10.1	38	72.6	6.4	53	1400	700	2800	1400	4.5	27°	17.7
GFB-20	20	40	11	20	12.5	47	89	8.4	65	1800	900	5500	2750	10.5	19°	32.8
GFB-25	25	48.5	14	25	12.6	58.5	101	8.4	75	3000	1500	6000	3000	10.5	15°	58.5
GFB-30	30	55	15	26	16	65	118	10.5	87.5	3500	1750	6500	3250	21.5	14°	78.9

GSB法兰关节轴承 Flange spherical bearings



产品特性 Product features

- 球体采用高耐磨材料EPB15制成
 - 保持器采用抗压和尺寸稳定性材料M163制成
 - 干运行、免维护
 - 抵抗灰尘和污垢
 - 补偿中心误差
 - 耐腐蚀，可用于液体介质环境
 - 重量轻、易安装
- Spherical ball made of highly wear-resistant EPB15
 - Housing made of high strength and shape-stable M163
 - Maintenance-free dry operation
 - Resistant to dust and dirt
 - Compensation of misalignment errors
 - Absolute corrosion resistance
 - Very light, easy installation

标准规格 Standard specifications

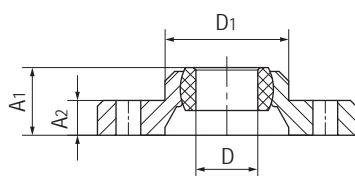
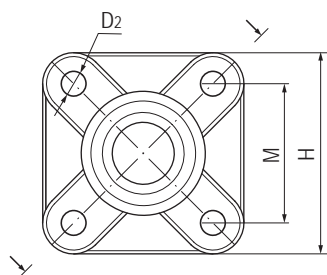

产品编码 Part No.:

GSB-04

内径 Inner diameter

产品编码 Part No.	d ₁ E10 [mm]	D ₁ [mm]	D ₂ [mm]	A ₁ [mm]	A ₂ [mm]	M [mm]	H [mm]	最大静载荷 Max. static load		最大径向静态负荷 Max. axial static load		最大静态转 矩 Max. tight-ening torque -Holes [Nm]	最大调节角度 Max. adjust angle	重量 Weight [g]
								短期 Sort-term [N]	长期 Long-term [N]	短期 Sort-term [N]	长期 Long-term [N]			
GSB-04	4	14	3.2	8.5	4.5	17	25	200	100	1000	500	0.6	28°	2.6
GSB-05	5	14	3.2	8.5	4.5	17	25	300	150	1000	500	0.6	29°	2.7
GSB-06	6	14	3.2	8.5	4.5	17	25	300	150	1000	500	0.6	25°	2.8
GSB-08	8	18	4.3	10.5	5.5	22	33	450	225	1400	700	1.3	25°	5.9
GSB-10	10	22	5.3	12	6.5	26	38	700	350	2000	1000	2.5	25°	9.1
GSB-12	12	25	5.3	13	7	28	40	850	425	2500	1250	2.5	21°	11
GSB-15	15	30	6.4	15.5	8.5	34	49	1100	550	3000	1500	4.5	20°	20.2
GSB-16	16	32	6.4	16.5	9	36	52	1350	675	3200	1600	4.5	27°	23.3
GSB-20	20	40	8.4	20	11	45	65	2000	1000	4000	2000	10.5	19°	45
GSB-25	25	48.5	8.4	25	14	52	74	2400	1200	5600	2800	10.5	15°	76
GSB-30	30	55	10.5	26	15	60	85	2800	1400	6000	3000	21.5	14°	100.7

GBB基座关节轴承 Pillow block spherical bearings



产品特性 Product features

- 球体采用高耐磨材料EPB15制成
 - 保持器采用抗压和尺寸稳定性材料M163制成
 - 干运行、免维护
 - 补偿中心误差
 - 高径向载荷并能承受边缘载荷
 - 耐化学液体腐蚀
 - 重量轻、节约空间、易安装
- Spherical ball made of highly wear-resistant EPB15
 - Housing made of high strength and shape-stable M163
 - Maintenance-free, self lubricating
 - Compensation for alignment errors
 - High radial loads and compensation of edge loads
 - Chemical resistant
 - Very low weight and space saving
 - Easy installation

标准规格 Standard specifications

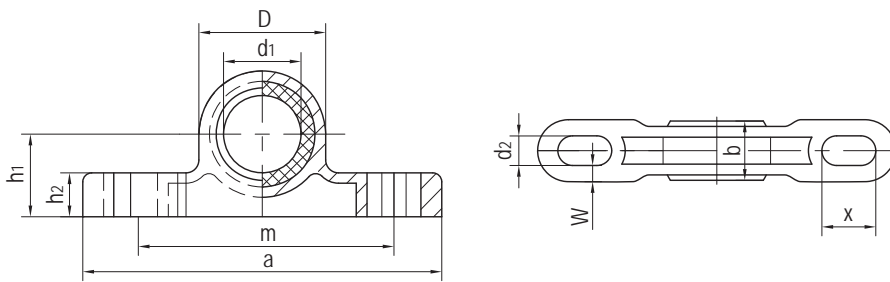

产品编码 Part No.:

GBB-16

内径 Inner diameter

产品编码 Part No.	d ₁ E10 [mm]	d ₂ [mm]	h ₁ [mm]	h ₂ [mm]	D [mm]	b [mm]	a [mm]	m [mm]	x [mm]	w [mm]	最大静态抗拉强度 Max. axial static compressive strength		最大静态抗拉 强度 Max. static tensile strength [N]	纵向孔最大 扭矩 Max. tightening torque for longitudinal holes [Nm]	重量 Weight [g]
											短期 Short-term [N]	长期 Long- term [N]			
GBB-16	16	6.6	18	10.5	SD31.7	13	86	60	12	4.2	3000	1500	1800	4.5	40
GBB-20	20	9	22	13	SD38	16	98	68	14	4.5	4700	2350	1300	10.5	54
GBB-25	25	9	27	16	SD46.7	20	124	86	17	6.5	6600	3300	1600	10.5	75.3
GBB-30	30	11	32	17	SD53.7	22	139	96	20	7	8100	4050	2100	21.5	116.8

GNB基座关节轴承，紧凑型 Pillow block spherical bearings, compact design



产品特性 Product features

- 球体采用高耐磨材料EPB15制成
 - 保持器采用硬质氧化镁铝合金制成
 - 干运行、免维护
 - 补偿中心误差
 - 高径向载荷并能承受边缘载荷
 - 重量轻、节约空间、易安装
- Spherical ball made of highly wear-resistant EPB15
 - Housing made of aluminum alloy with hard anodized surface
 - Maintenance-free, self lubricating
 - Compensation for alignment errors
 - High radial loads and compensation of edge loads
 - Very low weight and space saving
 - Easy installation

标准规格 Standard specifications

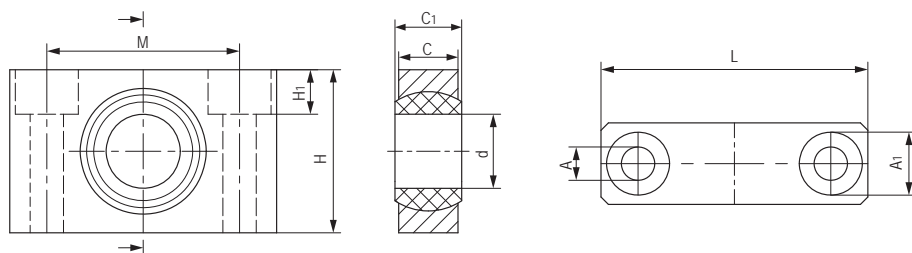

产品编码 Part No.:

GNB-08

内径 Inner diameter

产品编码 Part No.	d E10 [mm]	H [mm]	H ₁ [mm]	A [mm]	M [mm]	A ₁ [mm]	L [mm]	C [mm]	C ₁ [mm]	最大静态抗拉强度 Max. axial static compressive strength		最大径向抗压强度 Max. radial compressive strength		最大轴向抗压 Max. axial strength		最大 扭力 Max. torque [Nm]	重量 Weight [g]
										短期 Sort-term [N]	长期 Long-term [N]	短期 Sort-term [N]	长期 Long-term [N]	短期 Sort-term [N]	长期 Long-term [N]		
										GNB-08	8	19	/	4.5	22		
GNB-10	10	22	/	5.5	26	/	36	10	9	3400	1700	5300	2650	700	350	2.5	17
GNB-12	12	26	/	5.5	28	/	38	10	12	4600	2250	6500	3250	750	375	2.5	9
GNB-16	16	34	6.4	6.6	37	10.6	50	13	13	6700	3350	8500	4250	1100	550	4.5	30
GNB-20	20	40	8.6	9	46	14	62	16	16	8500	4250	11000	5750	1400	700	4.5	52
GNB-25	25	48	8.6	9	54	14	72	20	20	13500	6750	18500	9250	2300	1150	10.5	85
GNB-30	30	56	10.6	11	64	17	86	22	22	10000	5000	16500	8250	2500	1250	10.5	140

GDB双杆端关节轴承 Double spherical bearings



产品特性 Product features

- 球体采用高耐磨材料EPB15制成
 - 连接器采用高强度和尺寸稳定性材料M163制成
 - 自润滑、免维护
 - 耐腐蚀，可用于液体介质环境
 - 无噪音运行和不导电
 - 可连接两个单元组件并消除中心误差
 - 多种连接长度选择
- Spherical ball made of highly wear-resistant EPB15
 - Connection rod made of high strength and shape-stable M163
 - Maintenance-free dry operation
 - Corrosion-resistant
 - No noise and nonconductive
 - Mechanical connector between two components
 - Compensation of misalignment errors
 - Multichoice distance between two components

标准规格 Standard specifications

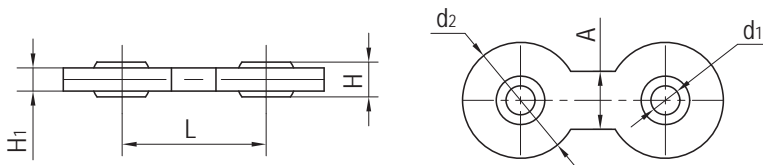

产品编码 Part No.:

GDB-04-25

— 中心距 Center distance
— 内径 Inner diameter

产品编码 Part No.	d ₁ E10 [mm]	d ₂ [mm]	L [mm]	A [mm]	H [mm]	H ₁ [mm]	最大静态轴向抗拉强度 Max. axial static tensile strength		最大径向静态抗拉强度 Max. radial static tensile strength		最大调节 角度 Max. pivot angle	重量 Weight [g]
							径向 Radial [N]	轴向 Axial [N]	径向 Radial [N]	轴向 Axial [N]		
GDB-04-25	4	20	25	10	5	4	1100	1300	550	650	32°	3.5
GDB-04-50	4	20	50	10	5	4	1100	750	550	375	32°	4.8
GDB-04-75	4	20	75	10	5	4	1100	500	550	250	32°	6.1
GDB-05-25	5	20	25	10	6	4	1100	1300	550	650	37°	2.2
GDB-05-50	5	20	50	10	6	4	1100	750	550	375	37°	4.9
GDB-05-75	5	20	75	10	6	4	1100	500	550	250	37°	6.3
GDB-06-25	6	20	25	10	6	4	1100	1300	550	650	30°	3.4
GDB-06-50	6	20	50	10	6	4	1100	750	550	375	30°	4.8
GDB-06-75	6	20	75	10	6	4	1100	500	550	250	30°	3.4
GDB-08-60	8	30	60	15	8	7	3000	3500	1500	1750	20°	15.2
GDB-08-100	8	30	100	15	8	7	3000	1900	1500	950	20°	19.5
GDB-10-60	10	30	60	15	9	7	2500	3500	1250	1750	25°	15.3
GDB-10-100	10	30	100	15	9	7	2500	1900	1250	950	25°	19.4
GDB-12-60	12	30	60	15	10	7	2000	3500	1000	1750	25°	14.7
GDB-12-100	12	30	100	15	10	7	2500	1900	1000	950	25°	18.8

GDB-F/GDB-R双杆端关节轴承 Double spherical bearings

产品特性 Product features

- 球体采用高耐磨材料EPB15制成
 - 保持器采用高强度和尺寸稳定性材料M163制成
 - 连接器采用高强度表面镀锌钢管
 - 自润滑、免维护
 - 无噪音和易安装
 - 多种角度调节
 - 多种长度选择
- Spherical ball made of highly wear-resistant EPB15
 - Housing made of high strength and shape-stable M163
 - Connection rod made of high strength steel with zinc coating surface
 - Maintenance-free dry operation
 - No noise and easy installation
 - Variable angle between two components
 - Variable distance between two components

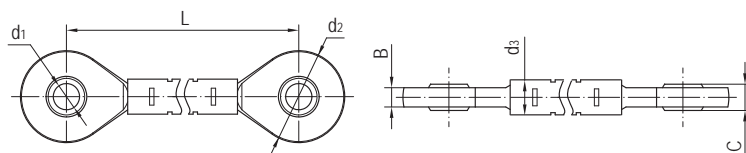
标准规格 Standard specifications

产品编码 Part No.:

GDB-06F-L

- 中心距 Center distance
- F: 球头角度 Ball stud direction 180°
- R: 球头角度 Ball stud direction 90°
- 内径 Inner diameter

产品编码 Part No.	d ₁ [mm]	d ₂ [mm]	d ₃ [mm]	L (Min) (最小值)	C [mm]	B [mm]	最大调节角度 Max. pivot angle
GDB-06F-L	6	21	8	72	6	4.4	40°
GDB-08F-L	8	24	10	84	8	6	35°
GDB-10F-L	10	29	12	96	9	7	35°
GDB-06R-L	6	21	8	72	6	4.4	40°
GDB-08R-L	8	24	10	84	8	6	35°
GDB-10R-L	10	29	12	96	9	7	35°

GOB杆端关节轴承，外螺纹 Rod end bearings, male thread



产品特性 Product features

- 球体采用高耐磨材料EPB15制成
 - 连接器采用高强度和尺寸稳定性材料M163制成
 - 自润滑、免维护
 - 光面设计耐灰尘
 - 很好的耐腐蚀性能
 - 补偿心中误差
 - 无噪音、重量轻
- Spherical ball made of highly wear-resistant EPB15
 - Connection rod made of high strength and shape-stable M163
 - Maintenance-free dry operation
 - Smooth design has no dirt traps
 - Absolute corrosion resistance
 - Compensation of misalignment errors
 - No noise and light weight

标准规格 Standard specifications

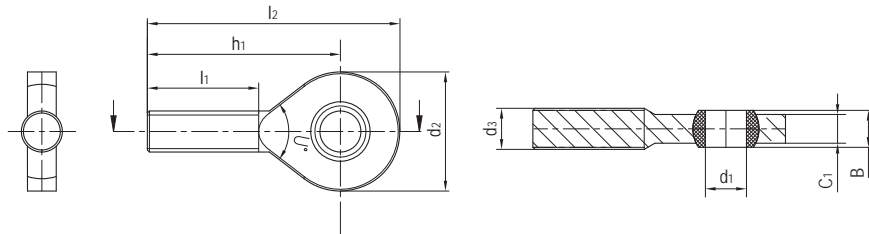

产品编码 Part No.:

GOBR-06

内径 Inner diameter

R: 右旋 Right

L: 左旋 Left

产品编码 Part No.	d ₁ [mm]	d ₂ [mm]	d ₃ [mm]	B [mm]	l ₁ [mm]	l ₂ [mm]	h ₁ [mm]	C ₁ [mm]	最大静态抗拉强度 Max. static tensile strength		最大径向静态负荷 Max. axial static load		最小螺纹 深度 Min. thread depth	球体最大扭矩 Max. tightening torque through ball	重量 Weight [g]
									短期 Sort-term [N]	长期 Long-term [N]	短期 Sort-term [N]	长期 Long-term [N]			
GOBR-06	6	21	M6	6	20	46.5	36	4.4	850	425	80	40	14	0.5	2.7
GOBR-08	8	24	M8	8	24	53	41	6	1600	800	160	80	17	2	5.1
GOBR-10	10	29	M10	9	27	62	47.5	7	2600	1300	250	125	19	5	8.4
GOBL-06	6	21	M6	6	20	46.5	36	4.4	850	425	80	40	14	0.5	2.7
GOBL-08	8	24	M8	8	24	53	41	6	1600	800	160	80	17	2	5.1
GOBL-10	10	29	M10	9	27	62	47.5	7	2600	1300	250	125	19	5	8.4

GIB杆端关节轴承，内螺纹 Rod end bearings, female thread



产品特性 Product features

- 球体采用高耐磨材料EPB15制成
 - 连接器采用高强度和尺寸稳定性材料M163制成
 - 自润滑、免维护
 - 光面设计耐灰尘
 - 很好的耐腐蚀性能
 - 补偿心中误差
 - 无噪音、重量轻
 - 带锁定螺母易安装
- Spherical ball made of highly wear-resistant EPB15
 - Connection rod made of high strength and shape-stable M163
 - Maintenance-free dry operation
 - Smooth design has no dirt traps
 - Absolute corrosion resistance
 - Compensation of misalignment errors
 - No noise and light weight
 - Simple assembly due to the integrated lock nut

标准规格 Standard specifications

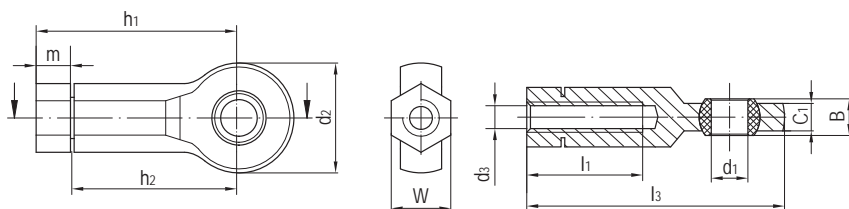

产品编码 Part No.:

GIBR-06

内径 Inner diameter
R: 右旋 Right
L: 左旋 Left

产品编码 Part No.	d ₁ [mm]	d ₂ [mm]	d ₃ [mm]	W [mm]	B [mm]	l ₁ [mm]	l ₃ [mm]	h ₁ [mm]	h ₂ [mm]	C ₁ [mm]	m [mm]	最大静态抗拉强度 Max. static tensile strength		最大径向静态 负荷 Max. axial static load		最小螺 纹深度 Min. thread depth	球体最大 扭矩 Max. tightening torque through ball	重量 Weight [g]
												短期 Sort-term [N]	长期 Long-term [N]	短期 Sort-term [N]	长期 Long-term [N]			
GIBR-06	6	21	M6	SW10	6	20	46.5	36.5	30	4.4	5.7	1500	750	200	100	8	2.5	4.5
GIBR-08	8	24	M8	SW13	8	25	56.3	44.3	36	6	7.5	200	1000	450	225	11	7	8.6
GIBR-10	10	29	M10	SW15	9	30	67.2	52.2	43	7	8.4	2300	1150	500	250	13	25	14.1
GIBL-06	6	21	M6	SW10	6	20	46.5	36.5	30	4.4	5.7	1500	750	200	100	8	2.5	4.5
GIBL-08	8	24	M8	SW13	8	25	56.3	44.3	36	6	7.5	200	1000	450	225	11	7	8.6
GIBL-10	10	29	M10	SW15	9	30	67.2	52.2	43	7	8.4	2300	1150	500	250	13	25	14.1

GSB-OP法兰关节轴承，连接销 Flange spherical bearings with pins



产品特性 Product features

- 基座采用高强度和尺寸稳定性材料M163制成
- 连接销采用镀锌钢，可选304不锈钢
- 免维护和耐腐蚀
- 易连接和安装
- 直接装配并节约安装空间
- Housing made of high strength and shape-stable M163
- Ball studs made of coating zinc steel, 304 stainless steel is available
- Maintenance-free and corrosion-resistant
- Easy connection - easy assembly
- Fits directly and space-saving

标准规格 Standard specifications

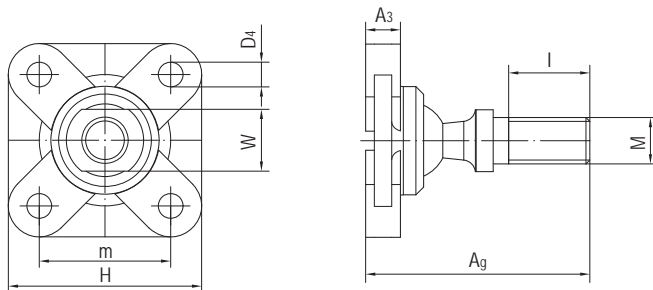

产品编码 Part No.:

GSB-OP-06

内径 Inner diameter

OP 外螺纹 Outer thread

产品编码 Part No.	M [mm]	m [mm]	H [mm]	Ag [mm]	A3 [mm]	I [mm]	D4 [mm]	W [mm]	最大静态径向负载 Max. static radial load		最大静态轴向负载 Max. static axial load		重量 Weight [g]
									短期 Sort-term [N]	长期 Long-term [N]	短期 Sort-term [N]	长期 Long-term [N]	
GSB-OP-06	M6	17	25	29	4.5	10.5	3.2	8	150	75	350	175	10.6
GSB-OP-08	M8	22	33	36	5.5	13.5	4.3	11	250	125	750	375	23.1
GSB-OP-10	M10	26	38	43.5	6.5	16	5.3	13	140	70	1200	600	41.2

*ES-不锈钢球头销根据要求提供 Stainless steel ball stud upon request

GSB-IP法兰关节轴承，连接销 Flange spherical bearings with pins



产品特性 Product features

- 基座采用高强度和尺寸稳定性材料M163制成
- 连接销采用镀锌钢，可选304不锈钢
- 免维护和耐腐蚀
- 易连接和安装
- 直接装配并节约安装空间
- Housing made of high strength and shape-stable M163
- Ball studs made of coating zinc steel, 304 stainless steel is available
- Maintenance-free and corrosion-resistant
- Easy connection - easy assembly
- Fits directly and space-saving

标准规格 Standard specifications

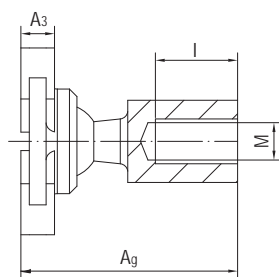
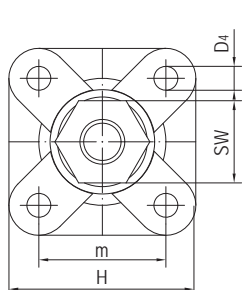

产品编码 Part No.:

GSB-IP-06

内径 Inner diameter

IP 内螺纹 Inner thread

产品编码 Part No.	M [mm]	m [mm]	H [mm]	A ₉ [mm]	A ₃ [mm]	I [mm]	D ₄ [mm]	SW [mm]	最大静态径向负载 Max. static radial load		最大静态轴向负载 Max. static axial load		重量 Weight [g]
									短期 Sort-term [N]	长期 Long-term [N]	短期 Sort-term [N]	长期 Long-term [N]	
GSB-IP-06	M6	17	25	29	4.5	11	3.2	SW11	150	75	350	175	16.4
GSB-IP-08	M8	22	33	36	5.5	12	4.3	SW14	250	125	750	375	34
GSB-IP-10	M10	26	38	43.5	6.5	16	5.3	SW17	140	70	1200	600	61.1

*ES-不锈钢球头销根据要求提供 Stainless steel ball stud upon request

GLBF法兰角支轴承 Flange spherical bearing



产品特性 Product features

- 免维护和耐腐蚀
 - 耐灰尘和污垢
 - 最大可调节安装公差 $\pm 0.2\text{mm}$
 - 易安装
- Maintenance-free and corrosion-resistant
 - Resistant to dust and dirt
 - Max tolerance compensation $\pm 0.2\text{mm}$
 - Easy installation

标准规格 Standard specifications

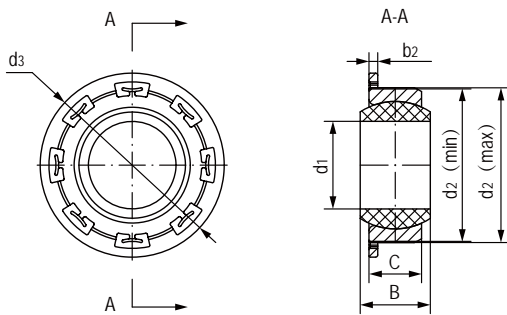

产品编码 Part No.:

GLBF-20

内径 Inner diameter

法兰设计 Flange design

产品编码 Part No.	d_1 [mm]	$d_{2(\min)}$ [mm]	$d_{2(\max)}$ [mm]	d_3 [mm]	C [mm]	B [mm]	b_2 [mm]	基座 _(min) [mm]	基座 _(max) [mm]	最大摆动 角度	重量Weight [g]
GLBF-20	20	34.8	35.6	42	12	16	2	34.8	35.2	18°	10

GTB塑料关节轴承 Plastic spherical bearings



产品特性 Product features

- 多种耐磨球体材料选择: M80, M81, EPB, EPB7, EPB13
 - 基座材料硬质镁铝合金
 - 自润滑、免维护
 - 易安装
 - 补偿中心误差
 - 消除边缘载荷
 - 小安装空间实现较好的耐磨性能
- Multiple spherical ball materials available: M80, M81, EPB, EPB7, EPB13
 - Housing made of aluminum alloy with hard anodized surface
 - Maintenance-free, dry-running
 - Easy assembly
 - Compensation of misalignment errors
 - Compensation of edge loads
 - Very good friction and wear properties in a small installation space

标准规格 Standard specifications

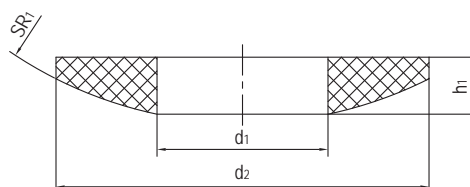
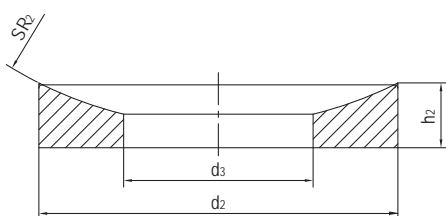

产品编码 Part No.	最大精态轴向抗拉强度 Max. static tensile strength		重量 Weight [g]
	短期 Short-term [N]	长期 Long-term [N]	
GTB-05-M80	4000	2000	0.9
GTB-06-M80	5000	2500	1.1
GTB-08-M80	8000	4000	2.2
GTB-10-M80	10000	5000	3.4
GTB-12-M80	12000	6000	5.9
GTB-16-M80	17000	8500	8.5
GTB-20-M80	22000	11000	12.8

产品编码 Part No.:

GTB-05-M80

球体材料 Ball material
内径 Inner diameter

产品编码 Part No.	d ₁ 球面垫片 Ball washer	d ₂ [mm]	d ₃ [mm]	总高 Total height [mm]	h ₁ [mm]	h ₂ [mm]	SR ₁ /SR ₂ [mm]	补偿角度 Compensation angle
GTB-05-M80	5.2	15	7	4.7	3	3.5	15	3°
GTB-06-M80	6.2	16	7.5	5.3	3	4	16	3°
GTB-08-M80	8.2	20	10	6.8	4	5	20	2°
GTB-10-M80	10.2	24	12	7.5	4.5	5.5	24	2°
GTB-12-M80	12.5	30	14.5	8	5	6.2	32	2°
GTB-16-M80	16.5	36	19	8.7	5.5	6.5	40	2°
GTB-20-M80	20.2	44	23	8.6	6	7	45	2°