

# Operation manual for KLEEdrive AC- motors



**KLEE**drive®

## List of Contents

<b>Introduction</b> .....	<b>4</b>
Declaration of Conformity .....	4
Validity .....	4
Environmental .....	4
<b>1. Types of KLEEdrive motors</b> .....	<b>4</b>
MS/MS2 .....	5
TxA .....	5
TxC .....	5
ML .....	5
MY .....	5
MC .....	6
<b>3. Handling</b> .....	<b>6</b>
Reception check .....	6
Transportation and storage .....	6
Lifting .....	6
Motor weight .....	7
<b>4. Mechanical installation</b> .....	<b>7</b>
General .....	7
Foundation .....	8
Balancing and fitting coupling halves and pulleys .....	8
Mounting and alignment .....	8
Slide rails and belt drives .....	9
<b>5. Cabling and electrical connections</b> .....	<b>9</b>
Insulation resistance check .....	9
Cabling .....	10
Connections for different starting methods .....	10
Connections of auxiliaries .....	11
Terminals and direction of rotation .....	11
Connection diagrams .....	11
Eco-Design brief .....	13
Variable speed operation .....	13
<b>6. Operation</b> .....	<b>14</b>
Use .....	14
Cooling .....	14

Safety considerations .....	14
Noise .....	14
<b>7. ATEX .....</b>	<b>15</b>
<b>8. Maintenance .....</b>	<b>15</b>
General inspection.....	15
Bearings .....	16
Motors with permanently greased bearings .....	16
Motors with regreasable bearings .....	16
Automatic lubrication.....	17
Lubrication intervals and amounts.....	17
Lubricants .....	19
<b>9. After sales support .....</b>	<b>19</b>
Ordering spare parts.....	19
Rewinding .....	20
Replacement of bearings.....	20
Basic view of spare parts for all types of motors .....	20
Table of spare parts, bearings and seals .....	21
Table of spare parts, bearings and seals for motor type TxA.....	21
Table of spare parts, bearings and seals for motor type TxC.....	22
<b>10. Troubleshooting.....</b>	<b>22</b>

## Introduction

### Note!

These instructions must be followed to ensure safe and proper installation, operation and maintenance of the motor. They should be brought to the attention of anyone who installs, operates and maintains the motor or associated equipment. The motor is intended for installation and use by qualified personnel, familiar with health and safety requirements and national legislation. Ignoring these instructions may invalidate all applicable warranties.

### Declaration of Conformity

Declaration of Conformity certificate with respect to the Low Voltage Directive 2014/35/EU, EMC-directive 2014/30/EU, RoHS directive 2011/65/EU, ATEX directive 2014/34/EU and the Ecodesign directive can issued separately on request. The declaration also satisfies the requirements of a declaration of incorporation with respect to the Machinery Directive 2006/42/EF.

### Validity

These instructions are valid for the following types of KLEEdrive motors:

Series: MS1/MS2(TM), MSB, MSD, MSC/MYC, MSV(TMV), MYV

Series: MY/MYT, ML, MC

Series: Y/Y2(TM), YC, T1C(TM), T2C(TM/TCF), T3C(TCF), TCI/TCP, TG, T1A, T2A, T3A

In frame sizes 56-355

### Environmental

By dismantling and removing the motor, it is important that the applicable local laws and regulations are followed. When the motor is worn out, it is important to recycle the motor or parts of the motor (mainly metal parts in steel, cast iron, aluminum and copper). This is done by returning the motor full or in single parts to an authorized metal recycling company. Packaging (pallets, cartons, paper, plastic, etc.) should also be submitted to regeneration / recycling.

## 1. Types of KLEEdrive motors

This section describes briefly the different types of KLEEdrive motors these instructions covers. In some sections there can be further information not mentioned in this section.

Common for all 3-phase motors:

- Minimum IP-class IP55
- Cooling according to IC411 for all frame sizes up to 355
- Manufactures for continuous duty S1
- B14-flange mounting up to frame size 160
- Standard voltage: 230/400V 50Hz (276/480V 60Hz), 400/690V 50Hz (480/828V 60Hz)
- Insulation class F (100°C) with class B (80°C) temperature rise (Insolation class H on request)
- Polyester coated copper windings, vacuum impregnated with high temperature varnish
- NSK bearings (C3) applied, preloaded with wave washer in DE. Cast iron motors (TxC) from frame size 160 supplied with open bearings with flush through after lubrication facilities.

### MS/MS2

- Three phase standard AC-motor
- Stator housing, end shields, flange and terminal box manufactured in aluminum.
- Frame sizes 56-200
- Detachable feet, standard terminal box on top, right and left mounting position for terminal box. (Stator housing symmetric)
- Efficiency class: MS=IE1, MS2=IE2

### TxA

- Three phase standard AC-motor
- Stator housing, end shields, flange and terminal box manufactured in aluminum.
- Frame sizes 80-200
- Detachable feet, standard terminal box on top, right and left mounting position for terminal box. (Stator housing symmetric)
- Efficiency class: T1A=IE1, T2A=IE2, T3A=IE3

### TxC

- Three phase standard AC-motor
- Stator housing, end shields, flange and terminal box manufactured in cast iron.
- Frame sizes 80-355
- Detachable feet up to frame size 280, standard terminal box on top, right and left mounting position for terminal box. (Stator housing symmetric)
- Efficiency class: T1C=IE1, T2C=IE2, T3C=IE3

### ML

- Single phase standard AC-motor with start- and run capacitor
- Stator housing, end shields, flange and terminal box manufactured in aluminum.
- Frame sizes 63-112
- Detachable feet, standard terminal box on top, right mounting position for terminal box (DE view).

### MY

- Single phase standard AC-motor with run capacitor
- Stator housing, end shields, flange and terminal box manufactured in aluminum.

- Frame sizes 56-100

Detachable feet, standard terminal box on top, right mounting position for terminal box (DE view).

## MC

- Single phase standard AC-motor with start capacitor
- Stator housing, end shields, flange and terminal box manufactured in aluminum.
- Frame sizes 63-112
- Detachable feet, standard terminal box on top, right mounting position for terminal box (DE view).

## 3. Handling

### Reception check

Examine the motor immediately after reception for external damages, especially damaged shaft, flange and painted surfaces. If damage is found, inform the forwarding agent immediately. Check all rating plate data, especially voltage and winding connection (star or delta). Type of bearings are specified in the product catalogue in frame sizes 56-132 and stated on the rating plate in frame sizes 160-355

### Transportation and storage

Store always the motor indoor (over 20°C), in dry, vibration- and dust free environment. Avoid mechanical shocks, falls and humidity during transportation. In other conditions consult Brd. Klee A/S.

Unprotected machined parts such as shaft and flange are from factory treated with corrosion protection.

It is recommended that the shaft is rotated periodically by hand to prevent grease migration.

Anti-condensation heaters, if fitted, are recommended to be used to avoid water condensing in the motor.

The motor must not be a subject to any external vibrations at standstill, as this will damage the bearings.

### Lifting

All KLEEdrive motors above 25 kg are equipped with lifting lugs or eyebolts.

Only these lifting lugs or eyebolts should be used for lifting the motor and only when the motor is NOT attached to other equipment (console or gear box). Lifting lugs for auxiliaries

(e.g. brakes, separate cooling fans etc.) or terminal boxes must not be used for lifting the motor.

Motors with same frame size may have different center of gravity due to different output, mounting arrangements and auxiliary equipment. Damaged lifting lugs must not be used. Check that the eyebolts and lifting lugs no are damaged before lifting. Eyebolts must be tightened before lifting. If needed, the position of the eyebolt can be adjusted using suitable washers as spacers.

Ensure that proper lifting equipment is used, and the size of the hook is suitable with the eyebolt or lifting lug.

Take care, not to damage auxiliary equipment or cables connected to the motor.

## Motor weight

The total motor weight can vary within the same frame size depending on output, mounting arrangement and auxiliaries. The following table shows **estimated** weight for the motors in basic versions in aluminum and cast iron. The actual weight of all KLEEdrive motors is shown in the product catalogue.

Frame size	Housing aluminum	Housing cast iron	+brake
<b>56</b>	4.0		1.0
<b>63</b>	5.0		1.0
<b>71</b>	7.0		1.5
<b>80</b>	11.2	19.0	1.9
<b>90</b>	17.6	27.0	3.4
<b>100</b>	27.3	38.0	5.0
<b>112</b>	35.7	50.0	7.0
<b>132</b>	65.0	84.0	11.5
<b>160</b>	97.5	147.0	13.0
<b>180</b>	128.0	195.0	29.0
<b>200</b>	158.0	270.0	45.0
<b>225</b>	-	320.0	55.0
<b>250</b>	-	427.0	-
<b>280</b>	-	667.0	-
<b>315</b>	-	1270.0	-
<b>355</b>	-	1850.0	-

## 4. Mechanical installation

### Warning!

Disconnect and lock out before working on the motor or the driven equipment.

### General

All values of the rating plate must be checked carefully, to ensure that the motor protection and connections will be properly done.

**Warning!**

In case of motors mounted with the shaft upwards and water or liquids are expected to go down along the shaft, the user must take in account to mount some means capable of preventing it.

Remove transport locking if employed. Turn shaft by hand to check free rotation if possible.

Motors equipped with roller bearings:

Running the motor with no radial force applied to the shaft may damage the roller bearing.

Motors equipped with angular contact bearings:

Running the motor with no axial force applied in the right direction in relation to the shaft may damage the angular contact bearing.

**Warning!**

For motors with angular contact bearings the axial force must not by any means change direction.

Motors equipped with re greasing nipples:

When starting the motor for the first time, or after long time storage, apply the specified quantity of grease. For details, see section 7.5

## Foundation

The end user has full responsibility for preparation of the foundation.

Foundations must be even, and sufficiently rigid to withstand possible short circuit forces.

They must be designed and dimensioned to avoid the transfer of vibration to the motor and vibration caused by resonance.

## Balancing and fitting coupling halves and pulleys

As standard, balancing of the motor has been carried out using half key.

Coupling halves and pulleys must be balanced after machining the keyways. Balancing must be done in accordance with the standard balancing method specified for the motor.

Coupling halves and pulleys must be fitted on the shaft using suitable equipment and tools which do not damage the bearings and seals. Never fit a coupling half or pulley by hammering or removing it using a lever pressed against the body of the motor.

## Mounting and alignment

Ensure that there is enough space for free airflow around the motor. Minimum distance behind the fan cover should be achieved.

Correct alignment is essential to avoid bearing, vibration and possible shaft failures.



Mount the motor on the foundation using the appropriate bolts or studs and place shim plates between the foundation and the feet. Align the motor using appropriate methods. If applicable, drill locating holes and fix locating pins into position. Check again the alignment after tightening of the bolts or studs.

### Slide rails and belt drives

Fasten the motor to the slide rails as shown at the drawing. Place the slide rails horizontally on the same level. Check that the motor shaft is parallel with the drive shaft. Belts must be tensioned according to the instructions of the supplier of the driven equipment.

#### **Warning!**

Excessive belt tension will damage bearing and can cause shaft damage.

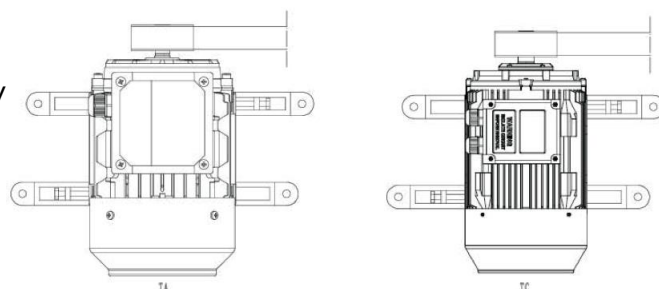

## 5. Cabling and electrical connections

### Insulation resistance check

Measure the insulation resistance before commissioning and when winding dampness is suspected.

#### **Warning!**

Disconnect and lock out before working on the motor or the driven equipment.

Insulation resistance, corrected to 25°C, must exceed the reference value, i.e. 100MΩ (measured with 500 or 1000VDC). The value is halved for each 20°C increase in the ambient temperature.

#### **Warning!**

The motor housing must be grounded and the windings should be discharged against the frame immediately after each measurement to avoid risk of electrical shock.

If the reference resistance value is not attained, the winding is too damp and must be oven dried. The oven temperature should be 90°C for 12-16 hours followed by 105°C for 6-8 hours.

Drain hole plugs, if fitted, must be removed. Valves, if fitted, must be opened during heating. After heating, make sure the plugs are refitted. Even if drain plugs are fitted, it is recommended to disassemble the end shields and terminal box covers for the drying process.

## Cabling

The terminal box on a standard single speed motor normally contains six winding terminals and at least one earth screw terminal. In addition to the main winding and earth terminals, the terminal box can also contain connections for thermistors (bi-metal, PTC, PT100 etc.), heating elements or other auxiliary devices. Suitable cable lugs must be used for the connection of all main cables. Cables for auxiliaries can be connected into their terminal blocks as such.

The motors are intended for fixed installation only!

Cable entry threads are metric, unless otherwise is specified. IP-class of the cable gland must be at least the same as those of the terminal boxes.

Unused cable entries must be closed with blanking elements according to the IP-class of the terminal box.

IP-class and diameter are specified in the documents relating to the cable gland.

### **Warning!**

Use appropriate cable glands and seals in the cable entries according to the type and diameter of the cable.

Earthing of the motor must be carried out according to local regulations before the motor is connected to the supply voltage.

Ensure that the motor protection corresponds to the environment and weather conditions; for example, make sure that water cannot enter the motor or the terminal boxes.

The seals of the terminal boxes must be placed correctly in the slots provided, to ensure the correct IP-class.

## Connections for different starting methods

The terminal box on standard single speed motors normally contains six winding terminals and at least on earth terminal. This enables the use of (Direct-On-Line) or Y/D (Star/Delta) starting. See section 5.6

For two-speed or special motors, the supply connection must follow the instructions inside the terminal box or in the motor manual.

The voltage and connection are stamped the terminal box cover inside.

DOL (Direct-On-Line) starting:

Y or D winding connection may be used.

KLEEdrive motors are normally with Y/D = 400V/230V for motor with small power (<4kW) and Y/D = 690V/400V for motors with big power (>4kW)

Y/D (Star/Delta) starting:

The supply voltage must be equal to the rated voltage of the motor when using the D-connection (Delta). All connection links MUST be removed from the terminal board!

### Connections of auxiliaries

If the motor is equipped with thermistors or other RTDs (PT100, bi-metal, PTC etc.) and other auxiliary devices, it is recommended they are used and connected by appropriate means. Maximum measuring voltage for standard thermistors is 2,5V. For bi-metallic sensors maximum load voltage/current is 250VAC/2A. Maximum measuring current for PT100 is 5mA. Using higher measuring voltage or current may cause errors in readings or damage the system. Read instructions for auxiliary devices.

### Terminals and direction of rotation

The shaft rotates clockwise (view from DE) when L1, L2, L3 in this sequence, is connected to U, V, W on the terminal board in section 5.6.

To alter the direction of rotation, interchange two phases on the supply cables. (L2, L1, L3).

If the motor is mounted with/on a unidirectional fan, ensure that it rotates in the same direction as the arrow marked on the motor or fan housing.

### Connection diagrams

Type MS/MS2/TxA/TxC three phase motor

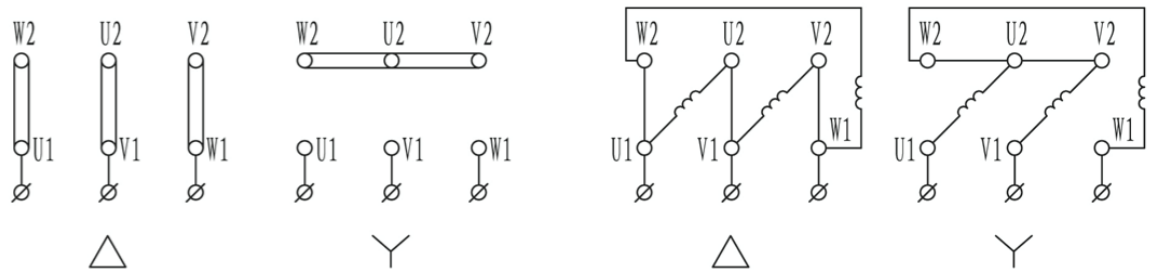

Type MC single phase motor with start capacitor

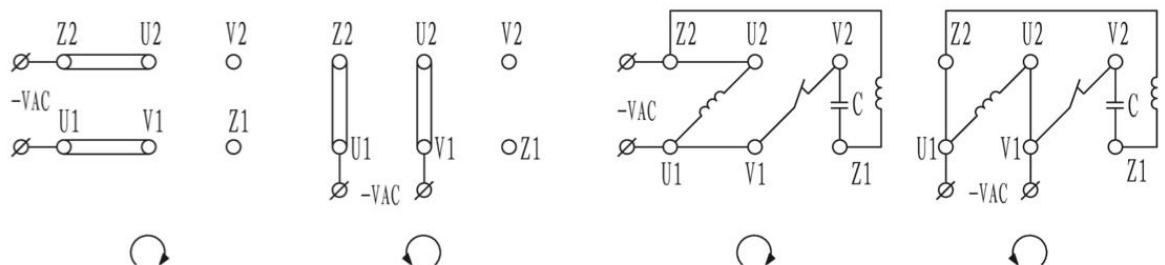

Type MY single phase motor with run capacitor

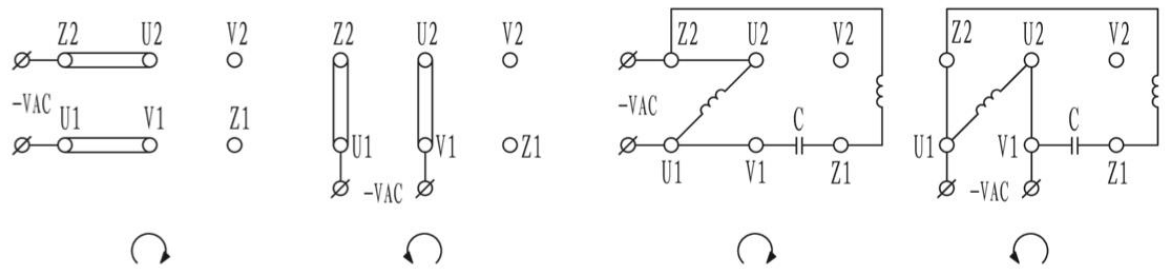

Type ML single phase motor with start and run capacitor

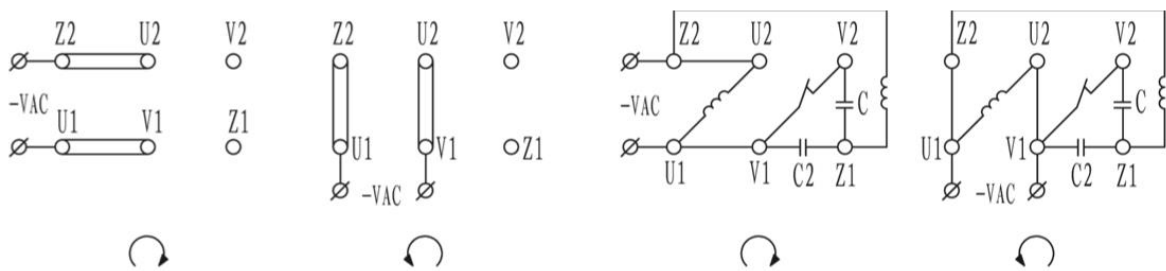

## Eco-Design brief

Since June 2011, there have been demands for Eco-Design of electric motors. Eco-Design is a demand for product design that meets a certain level of energy efficiency. See current and updated requirements according to the regulation on

<http://www.ens.dk/en/consumption-savings/energy-labelling-eco-design-appliances-products/eco-design>

General requirements for electric motors energy efficiency in three steps:

Rated power Pn	Step 1 June 16, 2011	Step 2 January 1, 2015	Step 3 January 1, 2017
$0,75\text{kW} \leq P_n < 7,5\text{kW}$	IE2	IE2	IE3 or IE2 controlled by frequency drive
$7,5\text{kW} \leq P_n \leq 375\text{kW}$		IE3 or IE2 controlled by frequency drive	

Source: Energistyrelsen

Requirements for information on the motor near or at the rating plate:

The nominal motor efficiency at 100%, 75% and 50% load, efficiency class IE2 or IE3, production year. See the example below.

According to current rules for motors in IE2 produced after January 1, 2015 the motor must be used with frequency drive and the rating plate marked variable speed (VSD use only).

See picture >>>

KLEEdrive		CE	
THREE - PHASE INDUCTION MOTOR			
FRAME MS2 801-2 B3		NO.1405037211	
INS.CL	F	IP 55	S1 VSD Use Only 2014.5
V $\Delta$ / Y	Hz	kW	rpm A $\Delta$ / Y cos $\Phi$
230/400	50	0.75	2840 2.93/1.69 0.81
276/480	60	0.9	3410 2.93/1.69 0.81
IE2 - 77.4 (100%) - 77.5 (75%) - 74.6 (50%)			

## Variable speed operation

As standard all KLEEdrive motors are designed for variable speed operation with phase-to-phase voltage  $\leq 500\text{V}$  and phase to ground voltage peaks at 1800V. The windings are double insulated and phase isolated.

EMC (ElectroMagnetic Compability):

Most standard variable speed drives will, due to the technology used, radiate an electric noise, in everyday speech called EMC. To minimize this it is recommended to:

- Use screened motor and control cables
- To replace cable glands in terminal box from plastic types to EMC-approved types in metal.

Thermal challenges:

It is recommended to incorporate thermal protection inside the motor, such as PTC, PT100, Bi-metallic sensors.

At continuous duty speed under 50Hz it is recommended to apply forced ventilation, as the motor self-cooling capability is not efficient at low speed. For more information (derating, torque etc.) consult Brd. Klee A/S.

Further requirements for motor/variable speed drive commissioning and energy efficient operation shall be fulfilled according to the demands from the manufacturer of the drive.

## 6. Operation

### Use

The motors are designed for the following conditions unless otherwise is stated on the rating plate:

- Normal ambient temperature limits are -20°C to +40°C
- Maximum altitude 1000m above sea level
- Tolerance for supply voltage is  $\pm 5\%$  and for frequency  $\pm 2\%$  according to EN/IEC 60034-1 (2004). Further information for different supply operation, consult Brd. Klee A/S.

### Warning!

Ignoring any of given instructions or maintenance of the motor may jeopardize the safety and thus prevents the use of the motor.

### Cooling

Check that the motor has sufficient airflow. Ensure that no nearby objects or direct sunshine radiate additional heat to the motor. For flange mounted motors (e.g. B5, B35, V1), make sure that the construction allows sufficient air flow on the outer surface of the flange.

### Safety considerations

The motor is intended for installation and use by qualified personnel, familiar with health and safety requirements and national legislation.

At the installation and operation site, safety equipment necessary for the prevention of accidents must be provided in accordance with local regulations.

### Warning!

Do not carry out work on motor, connection cables or accessories such as frequency drives, starters, brakes, thermistor cables or heating elements when voltage is applied.

### Points to observe:

- Do not step on the motor
- The temperature of the outer casing of the motor may be too hot to touch during normal operation and especially after shut-down.
- Some special motor applications require special instructions (e.g. using frequency drive)
- Be aware of rotating parts of the motor
- Do not open terminal boxes while energized.

### Noise

Most of KLEEdrive motors have a sound pressure level not exceeding 82 dB(A) at 50Hz.

Values for specific motors can be found in the relevant product catalogue. At 60Hz supply voltage (sinusoidal) the values are approximately 4 dB(A) higher compared with 50Hz values in the product catalogue.

## 7. ATEX

Only motors bearing the marking:

 II 3G Ex nA IIC T4 Gc, II 3D Ex tc IIIC T125°C Dc

are suitable to use in potentially explosive atmospheres accordingly.

Motors are designed as being non-sparking, Ex nA and Protected by enclosure, Ex tc.

**Special conditions for safe use:** Only suitable certified cable glands may be used. Installer must ensure that gasket is fitted correctly into terminal cover and all excess material is removed. Only metallic cooling wings may be used.

## 8. Maintenance

### Warning!

Voltage may be present at standstill inside the terminal box for heating elements or direct winding heating.

The capacitors in single phased motors can retain a charge that appears across the motor terminals, even when the motor has reached standstill.

A motor supplied from a frequency drive may energize even if the motor is at standstill.

### General inspection

- Inspect the motor at regular intervals, at least once a year. The frequency of checks depends on, for example, the humidity level of the ambient air and on the local weather conditions. This can initially be determined experimentally and must then be strictly adhered to.
- Keep the motor clean and ensure free ventilation airflow. If the motor is used in a dusty environment, the ventilation system must be regularly checked and cleaned.
- Check the condition of the shaft seals (e.g. V-ring or radial seal) and replace if necessary.
- Check the condition of connections and mounting and assembly bolts.
- Check the bearing condition by listening for any unusual noise, vibration measurement, bearing temperature, inspection of spent grease or bearing monitor. Pay special attention to bearings when their calculated rated life time is coming to an end. Inspect the maximum radial clearance of the bearings according to below table:

Internal dia. (mm)	20-30	35-50	55-70	75-100
Max. clearance (mm)	0,01	0,15	0,2	0,25

When signs of wear are noticed, dismantle the motor, check the parts and replace if necessary. When bearings are changed, replacement bearings must be of the same type as those originally fitted. The shaft seals have to be replaced with seals of the same quality and characteristics as the originals when changing bearings.

In the case of IP55 motor and when the motor has been delivered with a plug closed, it is advisable to periodically open the drain plugs in order to ensure that the way out for condensation is not blocked and allows condensation to escape from the motor. This operation must be done when the motor is at standstill and has been made safe to work on.

## Bearings

### Warning!

Beware of rotating parts!

Grease can cause skin irritation and eye inflammation. Follow all safety precautions specified by the manufacturer.

Bearing types are specified in the respective product catalogue.

Reliability is a vital issue for bearing lubrication intervals. KLEEdrive motors use mainly the L1-principle for lubrication.

## Motors with permanently greased bearings

Permanently greased bearings are usually 2Z with C3-clearance types.

The types of bearings are specified in relevant product catalogues.

Bearings for motor sizes up to 200 with adequate lubrication can achieve the following duration according to L10-principle. In below table the duration is listed at ambient temperatures of 25°C and 40°C:

Frame size	Poles	Duty 25°C (hrs.)	Duty 40°C (hrs.)
56-63	2-8	40.000	40.000
71	2-8	40.000	40.000
80-90	2-8	40.000	40.000
100-112	2	40.000	32.000
100-112	4-8	40.000	40.000
132	2	40.000	27.000
132	4-8	40.000	40.000
160	2	40.000	36.000
160	4-8	40.000	40.000
180	2	38.000	38.000
180	4-8	40.000	40.000
200	2	27.000	27.000
200	4-8	40.000	40.000
<b>Data valid at 50Hz, for 60Hz reduce values for 20 %</b>			

Depending on the application and load conditions, see the applicable product catalogue or consult Brd. Klee A/S.

Operations hours for vertical mounted motors are half of the above values.

## Motors with regreasable bearings

During the first start or after a bearing lubrication a temporary temperature rise may appear, approximately 10-20 hours.

### Manuel lubrication

Regreasing while the motor is running.

- Be sure that the lubrication channel is open



- Inject the specified amount of grease into the bearing
- Let the motor run for 1-2 hours to ensure that all excess grease is forced out of the bearing.

Regreasing while the motor is at a standstill

If it is not possible to regrease the bearings while the motor is running, lubrication can be carried out while the motor is at a standstill.

- Be sure that the lubrication channel is open
- In this case use only half the quantity of grease and then run the motor for a few minutes at full speed.
- When the motor has stopped, apply the rest of the specified amount of grease to the bearing.

### Automatic lubrication

The grease outlet plug must be removed permanently with automation lubrication.

It is recommended to use an electromechanical system only.

The amount of grease per lubrication interval stated in the table should be multiplied by four if an automatic regreasing system is used.

Note!

When 2-pole motors are automatically regreased, use high speed grease, where the speed factor is higher than 480.000. (Calculated as  $D_m \times n$ , where  $D_m$  = average bearing diameter in mm and  $n$  = rotation speed in rpm)

### Lubrication intervals and amounts

As a guide, adequate lubrication for motors with regreasable bearings can be achieved for the following duration, according to L1-principle. Lubrication intervals are based on an ambient temperature at 25°C. An increase in the ambient temperature raises the temperature of the bearings correspondingly. The values should be halved for a 15°C increase and may be doubled for a 15°C decrease. In doubt consult Brd. Klee A/S. See below table for lubrication intervals.

#### **Warning!**

The maximum operating temperature of the grease and bearings, +110°C, must not be exceeded. The designed maximum speed of the motor must not be exceeded.

#### **Note!**

Below table is indicative. Refer to the motor rating plate for specific amount and lubrication interval.

Frame size	Bearing size	Lubrication int. (hrs.)	Amount (gr.)
<b>160-2</b>	6309C3	12000	25
<b>160-4</b>	6309C3	21500	25
<b>160-6</b>	6309C3	24000	25
<b>160-8</b>	6309C3	24000	25
<b>180-2</b>	6311C3	9000	30
<b>180-4</b>	6311C3	18500	30
<b>180-6</b>	6311C3	24000	30
<b>180-8</b>	6311C3	24000	30
<b>200-2</b>	6312C3	8000	40
<b>200-4</b>	6312C3	17500	40
<b>200-6</b>	6312C3	23000	40
<b>200-8</b>	6312C3	24000	40
<b>225-2</b>	6313C3	6500	50
<b>225-4</b>	6313C3	16500	50
<b>225-6</b>	6313C3	22000	50
<b>225-8</b>	6313C3	24000	50
<b>250-2</b>	6314C3	4000	60
<b>250-4</b>	6314C3	11500	60
<b>250-6</b>	6314C3	15000	60
<b>250-8</b>	6314C3	18000	60
<b>280-2</b>	6316C3	3500	60
<b>280-4</b>	6316C3	10500	60
<b>280-6</b>	6316C3	14000	60
<b>280-8</b>	6316C3	17000	60
<b>315-2</b>	6317C3	3200	35
<b>315-4</b>	NU319/6319C3	3800/7600	55
<b>315-6</b>	NU319/6319C3	6900/11800	55
<b>315-8</b>	NU319/6319C3	6500/12900	55
<b>355-2</b>	6319C3	3200	35
<b>355-4</b>	NU322/6322C3	2800/5600	70
<b>355-6</b>	NU322/6322C3	4800/9600	70
<b>355-8</b>	NU322/6322C3	6400/10700	70
<b>355-10</b>	NU322/6322C3	7000/12000	70
<b>250-6</b>	6314	3000	80
<b>250-8</b>	6314	3000	80
<b>280-2</b>	6316	720	100
<b>280-4</b>	6316	2000	100
<b>280-6</b>	6316	3000	100
<b>280-8</b>	6316	3000	100
<b>315-2</b>	6317	500	120
<b>315-4</b>	NU319/6319	1500	140
<b>315-6</b>	NU319/6319	3000	140
<b>315-8</b>	NU319/6319	3000	140

## Lubricants

### Warning!

Do not mix different types of grease.

Please always refer to the motor rating plate for used grease.

Incompatible lubricants may cause bearing damage.

Used standard lubricant from manufacturer has properties as:

- Good quality grease with lithium complex soap and with mineral- or PAO-oil.
- Base oil viscosity 100-160cST at 40°C
- Consistency NLGI class 1.5-3 \*)
- Temperature range -30°C - +120°C, continuously

\*) For vertical mounted motors or in hot conditions a stiffer end of scale is recommended.

The above mentioned grease specification is valid if the ambient temperature is above -30°C or below +55°C, and the bearing temperature is below 110°C.

Grease with the correct properties is available from all major lubricant manufacturers.

Admixtures are recommended, but a written guarantee must be obtained from the lubricant manufacturer, especially concerning EP mixtures, the admixtures do not damage bearings or the properties of lubricants at the operating temperature range.

### Warning!

Lubricants containing EP admixtures are not recommended in high bearing temperatures in frame sizes 280-355.

The following high performance greases can be used:

- Mobile Polyrex (Standard used from factory)
- Esso Unirex N2 or N3 (Lithium complex base)
- Mobil Mobilith SHC 100 (Lithium complex base)
- Shell Albida EMS 2 (Lithium complex base)
- Klüber Klüberplex BEM 41-132 (Special Lithium base)
- FAG Arcanol TEMP110 (Lithium complex base)
- Lubcon Turmogrease L802 EP PLUS
- Total Multiplex S 2 A (Lithium complex base)

If other lubricants are used:

Check with the manufacturer that the qualities/performance correspond to those of the above mentioned lubricants.

## 9. After sales support

### Ordering spare parts

When ordering spare parts, please indicate: full motor type designation, serial no., product code and production date, as stated at the motor rating plate. For more information visit

[www.klee.dk](http://www.klee.dk)

## Rewinding

Rewinding should also be carried out by qualified repair shops. Consult Brd. Klee A/S for further information.

## Replacement of bearings

Special care should be taken with the bearings. Defective bearing must be removed using pullers and new bearing fitted by heating or special tools for the purpose.

## Basic view of spare parts for all types of motors

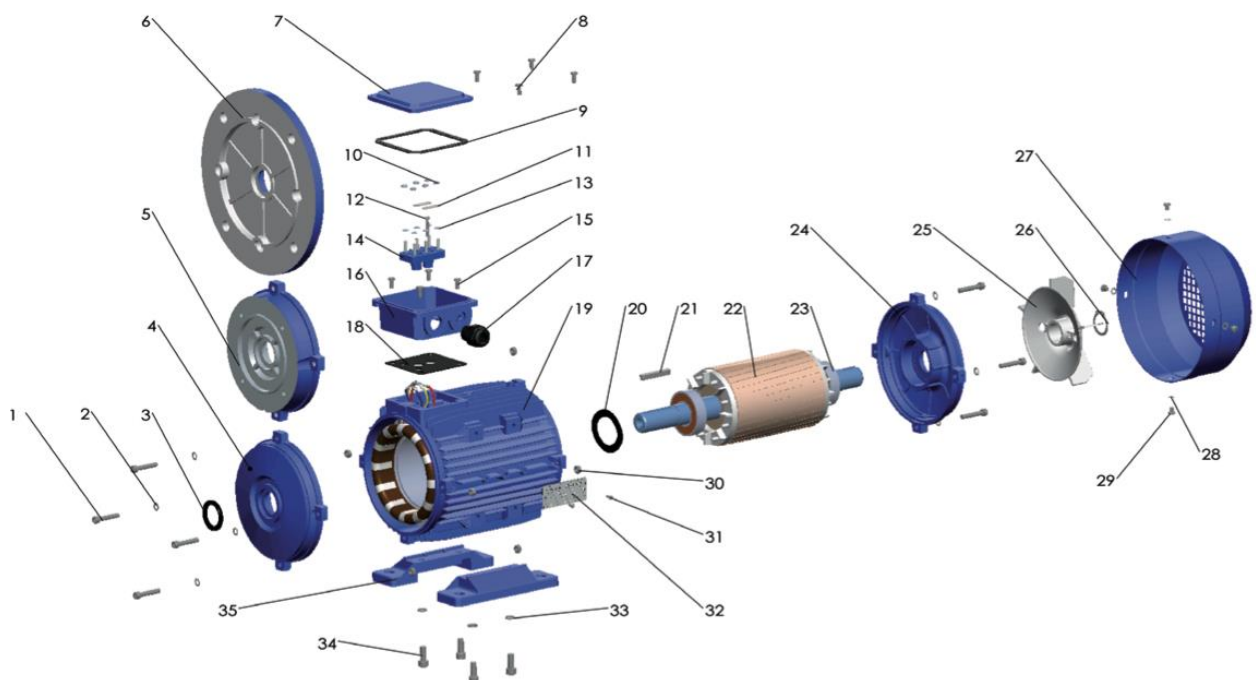

1	Screw
2	Gasket
3	Oil seal
4	Front end shield
5	B14 flange
6	B5 flange
7	Terminal box cover
8	Terminal box fixing screws

13	Terminal shim
14	Terminal board
15	Terminal box fixing screws
16	Terminal box
17	Cable gland
18	Terminal box bottom gasket
19	Motor housing (frame)
20	Wave washer for preload

25	Cooling fan
26	Fan circlip
27	Fan cover
28	Fan cover fixing shim
29	Fan cover fixing screws
30	End shield fixing nut
31	Rivet for rating plate
32	Rating plate

9	Terminal box upper gasket	21	Key	33	Foot fixing nut
10	Terminal box fixing nut	22	Rotor	34	Foot fixing screws
11	Terminal bridge	23	Bearing	35	Foot B3
12	Terminal pin	24	Rear end shield		

### Table of spare parts, bearings and seals for motor type MS/MS2

All bearings must have C3 clearance

Frame size	Bearing		Seal	
	Shaft side (DE)	Fan side (NDE)	Shaft side (DE)	Fan side (NDE)
<b>56</b>	6201	6201	12x22x5	12x22x5
<b>63</b>	6201	6201	12x24x7	12x24x7
<b>71</b>	6202	6202	15x25x7	15x25x7
<b>80</b>	6204	6204	20x34x7	20x34x7
<b>90</b>	6205	6205	25x37x7	25x37x7
<b>100</b>	6206	6206	30x44x7	30x44x7
<b>112</b>	6306	6206	30x44x7	30x44x7
<b>132</b>	6308	6208	40x58x8	40x58x8
<b>160</b>	6309	6309	45x65x8	45x65x8
<b>180</b>	6311	6211	55x72x8	55x72x8
<b>200</b>	6312	6212	60x80x8	60x80x8

### Table of spare parts, bearings and seals for motor type TxA

All bearings must have C3 clearance

Frame size	Bearing		Seal	
	Shaft side (DE)	Fan side (NDE)	Shaft side (DE)	Fan side (NDE)
<b>80</b>	6204	6204	20x34x7	20x34x7
<b>90</b>	6205	6205	25x37x7	25x37x7
<b>100</b>	6206	6206	30x44x7	30x44x7
<b>112</b>	6306	6206	30x44x7	30x44x7
<b>132</b>	6308	6208	40x58x7	40x58x7
<b>160</b>	6309	6209	45x65x8	45x65x8
<b>180</b>	6311	6311	55x75x8	55x75x8
<b>200</b>	6312	6312	60x80x8	60x80x8

## Table of spare parts, bearings and seals for motor type TxC

All bearings must have C3 clearance

Frame size	Bearing		Seal	
	Shaft side (DE)	Fan side (NDE)	Shaft side (DE)	Fan side (NDE)
<b>80</b>	6204	6204	20x34x7	20x34x7
<b>90</b>	6205	6205	25x37x7	25x37x7
<b>100</b>	6206	6206	30x44x7	30x44x7
<b>112</b>	6306	6306	30x44x7	30x44x7
<b>132</b>	6308	6308	40x58x7	40x58x7
<b>160</b>	6309	6309	45x65x8	45x65x8
<b>180</b>	6311	6311	55x75x8	55x75x8
<b>200</b>	6312	6312	60x80x8	60x80x8
<b>225</b>	6313	6313	65x90x10	65x90x10
<b>250</b>	6314	6314	70x95x10	70x95x10
<b>280</b>	6316	6316	80x100x10	80x100x10
<b>315-2</b>	6317	6317	85x110x12	85x110x12
<b>315-4/6/8</b>	NU319	6319	95x120x12	95x120x12
<b>355-2</b>	6319	6319	95x120x12	95x120x12
<b>355-4/6/8</b>	NU322	6322	110x130x12	110x130x12

## 10. Troubleshooting

These instructions do not cover all details or variations for every possible condition to be met in connection with installation, operation or maintenance.

Motor troubleshooting chart

The chart is made for qualified persons who have proper tools and equipment, to make service and troubleshooting.

Trouble	Cause	Solution
Motor do not start	Blown fuses	Replace fuses with proper type and rating
	Overload trips	Check and reset overload in starter
	Improper power supply	Check to see that power supplied agrees with motor rating plate and load factor
	Improper line connections	Check connections against diagram supplied with motor
	Open circuit in winding or control switch	Indicated by humming sound when switch is closed. Check for loos wiring connections. Also ensure that all control contacts are closing
	Mechanical failure	Check to see if motor and drive turn freely. Check bearings and lubrication
	Short circuited stator	Indicated by blown fuses. Motor must be rewound
	Poor stator coil connection	Remove end shields, locate fault

	Rotor defective	Look for broken bars or end rings
	Motor may be overloaded	Reduce load

Trouble	Cause	Solution
Motor stalls	One phase may be open	Check lines for open phase
	Wrong application	Change type or size. Consult equipment supplier
	Overload	Reduce load
	Low voltage	Ensure the rating plate voltage is maintained. Check connection
	Open circuit	Fuses blown. Check overload relay, stator and push buttons
Motor runs and then dies down	Power failure	Check for loose connections to line, to fuses and to control
Motor does not come up to nominal speed	Not applied properly	Consult equipment supplier for proper type
	Voltage too low at motor terminals due to line drop	Use higher voltage or transformer terminals or reduce load. Check connections. Check conductors for proper size
	Starting load too high	Check the start load of the motor
	Broken rotor bars or loose rotor	Look for cracks near the rings. A new rotor may be required, as repairs are usually temporary
	Open primary circuit	Locate fault with testing device and repair
Motor takes too long to accelerate and/or draws high current	Excessive load	Reduce load
	Low voltage during start	Check for high resistance. Make sure that adequate cable size is used
	Defective rotor	Replace with new rotor
	Applied voltage too low	Correct power supply
Wrong rotation direction	Wrong sequence of phases	Interchange two phases at the motor or the switch board
Motor overheats while running	Overload	Reduce load
	Frame or ventilation openings may be full of dirt and prevent proper ventilation of motor	Open ventilation holes and check for a continuous stream of air from the motor
Motor overheats while running	Motor may have one phase open	Check to make sure that all leads are well connected
	Grounded coil	Motor must be rewound
	Unbalanced terminal voltage	Check for faulty leads, connections and transformers.

Trouble	Cause	Solution
Motor vibrates	Motor misaligned	Realign
	Weak support	Strengthen base
	Coupling out of balance	Balance coupling
	Driven equipment unbalanced	Balance driven equipment
	Defective bearings	Replace bearings
	Bearings not in line	Repair motor
	Balancing weights shifted	Rebalance motor
	Contradiction between balancing of rotor and coupling (half key-full key)	Rebalance coupling or motor
	Three phase motor running single phase	Check for open circuit
	Excessive end play	Adjust bearing or add shim
Scraping noise	Fan rubbing end shield of fan cover	Correct fan mounting
	Loose on bedplate	Tighten holding bolts
Noisy operation	Air gap not uniform	Check and correct end shield fits or bearing fits
	Rotor unbalanced	Rebalance rotor
Hot bearings	Bent or sprung shaft	Straighten or replace shaft
	Excessive belt pull	Decrease belt tension
	Pulleys too far away from shaft shoulder	Move pulley closer to motor bearing
	Pulley diameter too small	Use larger pulleys
	Misalignment	Correct by realignment of the drive
	Insufficient grease	Maintain proper quality and amount of grease in bearing
	Deterioration of grease or lubricant contaminated	Remove old grease, wash bearings thoroughly in kerosene and replace with new grease
	Excess lubricant	Reduce quantity of grease, bearing should not be more than half full
	Overload bearing	Check alignment, side and end thrust
	Broken ball or rough races	Replace bearing, clean housing thoroughly first