

# Comprehensive<sup>®</sup> Reverse Shoulder System

Surgical Technique





# Table of Contents

<b>Patient Positioning, Surgical Incision/Exposure</b> .....	2
<b>Humeral Stem Technique</b> .....	4
Humeral Preparation	
Interamedullary Resection Guide	
Humeral Broaching	
Calcar Planer	
Humeral Stem Insertion – Press Fit Technique	
Humeral Stem Insertion – Cemented Technique	
<b>Glenoid</b> .....	14
Glenoid Preparation	
Baseplate Impaction	
Baseplate Central Screw Selection/Insertion	
Peripheral Screw Selection/Insertion	
Peripheral Screw Selection/Insertion (Optional Method)	
Glenosphere Selection	
Glenosphere Offset	
Glenosphere Assembly	
Glenosphere/Taper Adaptor Offset Direction Determination	
Glenosphere Orientation/Impaction	
<b>Humeral Tray and Bearing</b> .....	26
Humeral Tray and Bearing Preparation	
Humeral Tray and Bearing Assembly	
Humeral Tray/Bearing Impaction	
<b>Subscapularis Repair</b> .....	28
<b>Revision Options</b> .....	29
Removal of Glenosphere/Baseplate	
Polyethylene Preparation	
Polyethylene Removal	
<b>Central Post Removal</b> .....	30
<b>Salvage Hemi-arthroplasty</b> .....	30
Removal of the Humeral Tray/Bearing	
<b>Polyethylene Humeral Bearing Removal/Exchange</b> .....	31
<b>Fracture: Tuberosity Reconstruction</b> .....	32
Proximal Humerus Fractures	
<b>Humeral Stem Sizing</b> .....	35
Standard Stem	
Mini Stem	
Micro Stem	
Comprehensive Fracture System Sizing Chart	
<b>Ordering Information</b> .....	37

## INDICATIONS

Biomet Comprehensive Reverse Shoulder products are indicated for use in patients whose shoulder joint has a grossly deficient rotator cuff with severe arthropathy and/or previously failed shoulder joint replacement with a grossly deficient rotator cuff. The patient must be anatomically and structurally suited to receive the implants and a functional deltoid muscle is necessary.

The Comprehensive Reverse Shoulder is indicated for primary, fracture, or revision total shoulder replacement for the relief of pain and significant disability due to gross rotator cuff deficiency.

Titanium glenospheres are intended for patients with Cobalt Alloy material sensitivity. The wear of these devices has not been tested but, based on pin on disk testing, the wear rate is inferior to that of cobalt alloy glenospheres. A Cobalt Alloy glenosphere is the recommended component for reverse shoulder arthroplasty patients without material sensitivity to cobalt alloy.

Glenoid components with Hydroxyapatite (HA) coating applied over the porous coating are indicated only for uncemented biological fixation applications. The Glenoid Baseplate components are intended for cementless application with the addition of screw fixation.

Interlok<sup>®</sup> finish humeral stems are intended for cemented use and the MacroBond<sup>®</sup> coated humeral stems are intended for press-fit or cemented applications. Humeral components with porous coated surface coating are indicated for either cemented or uncemented biological fixation applications.

## CONTRAINDICATIONS

Absolute contraindications include infection, sepsis, and osteomyelitis.

Relative contraindications include:

1. Uncooperative patient or patient with neurologic disorders who is incapable or unwilling to follow directions.
2. Osteoporosis.
3. Metabolic disorders which may impair bone formation.
4. Osteomalacia.
5. Distant foci of infections which may spread to the implant site.
6. Rapid joint destruction, marked bone loss or bone resorption apparent on roentgenogram.



Figure 1



Figure 2

## Patient Positioning and Incision

### Surgical Position

The arm and shoulder are prepped and draped free (Figure 1). Utilize a modified beach chair position at about 30 to 40 degrees of flexion.

### Surgical Incision/Exposure

Utilize an extended deltopectoral anterior incision beginning immediately above the coracoid process and extending distally and laterally, following the deltopectoral groove along the anterior border of the deltoid (Figure 2). Laterally retract the deltoid muscle, avoiding release of the deltoid from the clavicle. The deltoid may be partially released from its distal insertion by subperiosteal dissection.

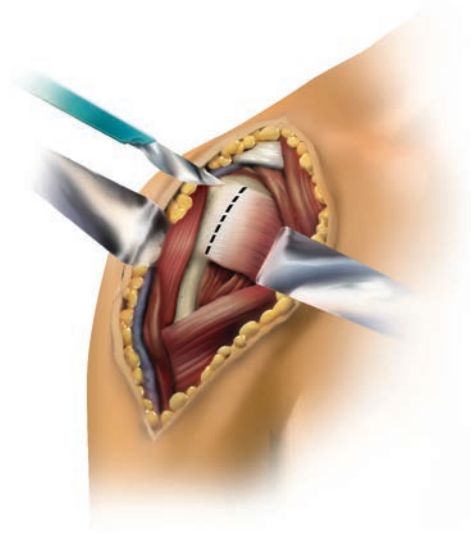

Figure 3

## Patient Positioning and Incision (cont.)

Identify anterior structures and externally rotate the humerus. If the subscapularis is intact, make a longitudinal incision through the tendinous portion of the subscapularis muscle and capsule, just medial to the lesser tuberosity (Figure 3). In cases of severe contracture, subscapularis lengthening may be required.

Tag the subscapularis tendon with non-absorbable sutures for easy identification during closure. Externally rotate and extend the humerus to expose the humeral head, while protecting the axillary nerve.

ⓘ **Note:** An optional biceps tenodesis may be performed to improve exposure.

## Standard, Mini, and Micro Stem Technique

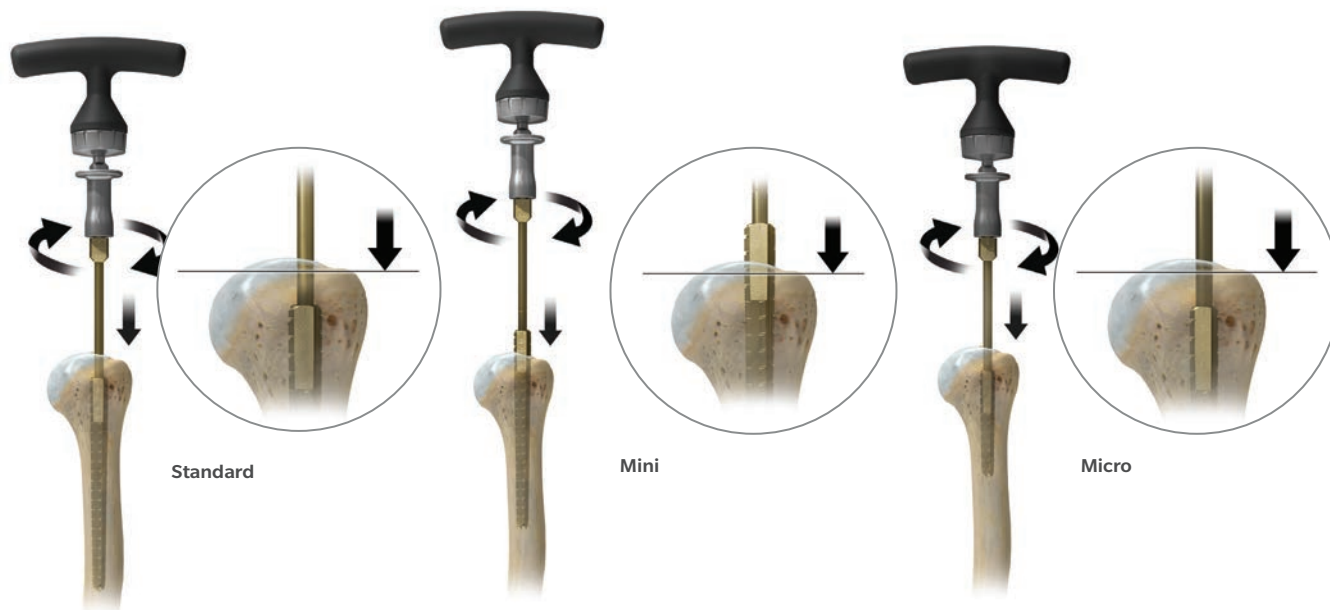

Standard

Mini

Micro

Figure 4

Figure 5

Figure 6

## Humeral Preparation

Using the 4, 5 or 6 mm starter reamer and ratcheting T-handle, bore a pilot hole through the humeral head along the axis of the humeral shaft, just lateral to the head's articular surface and just medial to the rotator cuff attachment. Insert the humeral reamer to the depths described below for the chosen stem. Continue reaming in 1 mm increments until cortical contact is achieved. Note the reamer size for future reference.

**Standard Stem** – Using the standard length reamers, insert each reamer until the proximal portion of the engraved line just above the cutting teeth is even with the proximal portion of the greater tuberosity (Figure 4).

**Mini Stem** – Using the standard length reamers, insert each reamer until the large hashmark between the 3 and 4 on the reamer is even with the proximal portion of the greater tuberosity (Figure 5).

**Micro Stem** – Using the Micro length reamers, insert each reamer until the engraved line just above the cutting teeth is even with the proximal portion of the greater tuberosity (Figure 6).

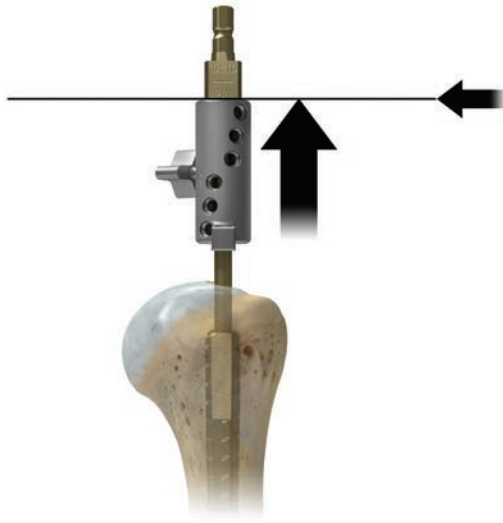

Standard/Micro

Figure 7

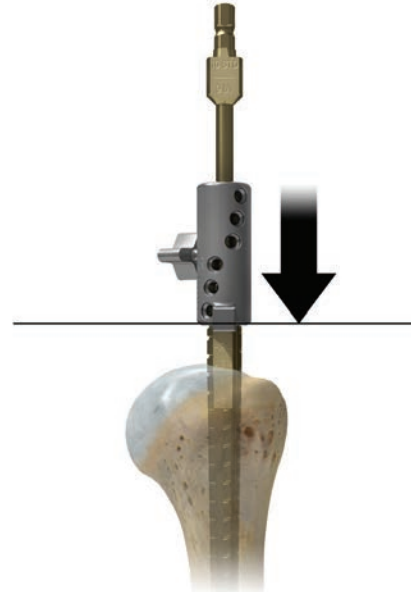

Mini

Figure 8

## Intramedullary Resection Guide

Place the resection guide boom onto the reamer shaft to the below described locations depending on stem selection.

**Note:** The position of the resection guide boom on the reamer shaft, along with the calibrated reaming depth and stem choice, are directly related to the proper resection height. However, the final resection height should be based off the location of the rotator cuff insertion (approximately 1 mm above the insertion). An ideal humeral resection is slightly above the rotator cuff insertion. This allows for greater glenoid exposure.

**Standard Stem** – Place the resection guide boom on the reamer shaft and slide it up until it rests against the top of the reamer, just below the sizing engraving (Figure 7).

**Mini Stem** – Place the resection guide boom on the reamer shaft and slide it down until it rests against the base surface of the reamer, just above the cutting teeth (Figure 8).

**Micro Stem** – Place the resection guide boom on the reamer shaft and slide it up until it rests against the top of the reamer, just below the sizing engraving (Figure 7)

**Note:** The resection guide boom is NOT engraved with Micro.





Standard/Micro

Figure 9



Mini

Figure 10

## Intramedullary Resection Guide (cont.)

Place the IM resection guide block onto the arm of the boom in the proper orientation. For example, “right” should be visible for a right shoulder.

ⓘ **Note:** In chronic or fixed shoulders, a more aggressive humeral resection may be made at this point to create increased joint space for placement of the prosthesis. If there is uncertainty regarding the resection height, a standard resection should still be performed with the option to resect more bone later in the procedure.

Standard and Micro Technique (Figure 9). Mini Technique (Figure 10).

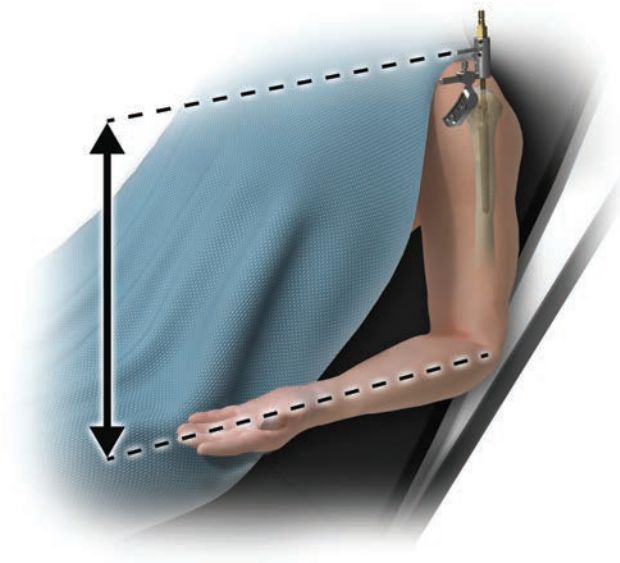
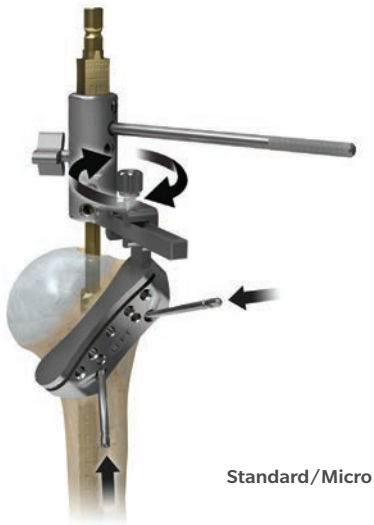

Figure 11

## Intramedullary Resection Guide (cont.)

Screw the version rod into the appropriate version hole, and align the rod with the forearm flexed at 90 degrees (Figure 11).

ⓘ **Note:** The thumb screw on the resection boom is not captured. Care should be taken when adjusting/ tightening



Standard/Micro

Figure 12

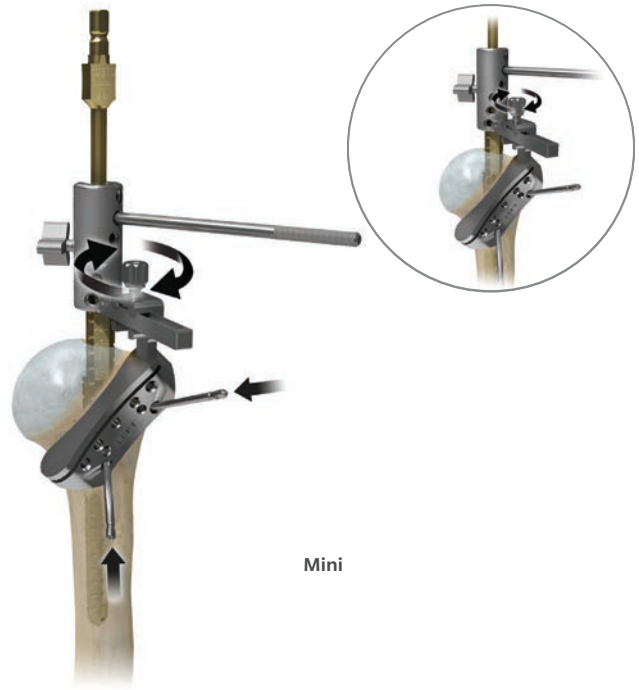

Mini

Figure 13

## Intramedullary Resection Guide (cont.)

Set the correct version using the amount of external rotation of the forearm, slide the resection guide against the humerus and finger tighten the thumb screw.

ⓘ **Note:** The thumb screw on the resection boom is not captured. Care should be taken when adjusting/ tightening.

Place two threaded Steinman pins through converging angled holes in the resection guide block and into the bone to secure the block to the bone. Standard and Micro Technique (Figure 12). Mini Technique (Figure 13).



Standard/Micro

Figure 14



Mini

Figure 15

## Intramedullary Resection Guide (cont.)

Completely loosen the thumb screw on the resection guide block and reamer shaft. Rotate the resection guide boom until the arm clears the resection block.

Standard and Micro Technique (Figure 14). Mini Technique (Figure 15). Remove the reamer and guide boom.



Figure 16



Figure 17



Figure 18

## Intramedullary Resection Guide (cont.)

Prior to making the humeral resection, the planned resection should be confirmed with the angel wing/tissue probe. Place a saw blade through the cutting slot in the guide. The saw blade should be moving when it comes in contact with the bone (Figure 16). Resect the humeral head. Remove the Steinmann pins and the cut block.

## Humeral Broaching

Select a broach that is at least 2 to 3 mm smaller than the last reamer used and attach it to the broach handle.

**Standard and Mini Stem** – Use Mini length broaches (Figure 17).

**Micro Stem** – Use Micro length broaches (Figure 18).



Figure 19



Figure 20

## Humeral Broaching (cont.)

Insert the version rod into the same position used during resection. Flex the forearm to 90 degrees, and externally rotate the arm to be parallel with the version control rod indicating the chosen amount of retroversion. Sequentially broach in 1 mm increments until the broach size is equal to the size of the humeral reamer. For example, if the etching on the last reamer used indicated 10 mm, broach up to 10 mm (Figure 19).

**Tip:** Advance each broach into the humerus in several successive motions, tapping it up as well as down between advancements. The broach is fully seated when the collar on the broach handle rests on the resected surface of the humerus. Remove the broach handle, leaving the last broach in place to be used as a trial.

**Caution:** If the broach feels too tight and will not seat, finish broaching with next smaller size.

ⓘ **Note:** An optional broach cover can be used to protect the humerus while the glenoid is prepared.

ⓘ **Note:** The porous coating on the humeral stem is 0.75 mm thick on all sides (1.5 mm circumferentially), which will cause the final implant to fit tighter than the broach.

## Calcar Planer

Use the calcar planer to refine the resected surface. Attach the planer blade that most closely matches the diameter of the resected surface to the barrel of the calcar planer. Insert the planer plunger into the female taper of the broach. Begin rotation of the calcar planer before contacting the resected surface. Apply slight pressure and plane the resected surface (Figure 20).

ⓘ **Note:** The calcar planer should not be used in conjunction with the definitive implant. This could potentially damage the reverse Morse taper.

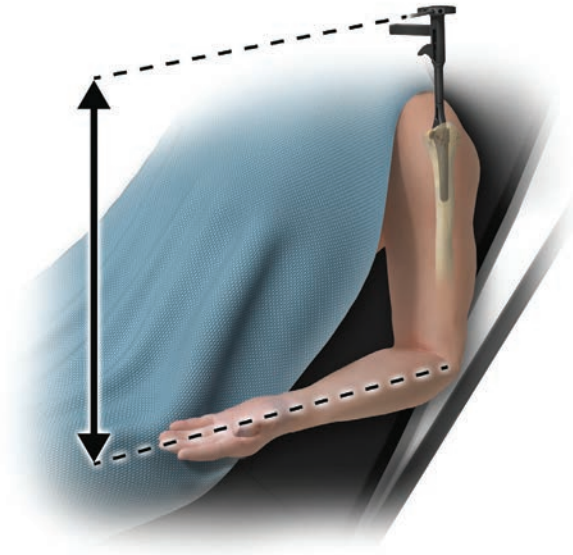

Figure 21



Figure 22

### Humeral Stem Insertion – Press-fit Technique

Attach the broach handle to the broach/trial, and remove it from the humeral canal. Select a humeral stem which matches the final broach/trial used. Assemble the humeral stem onto the humeral stem inserter. Place the version control rod into the appropriate version hole and align it with the forearm flexed at 90 degrees (Figure 21).

Insert the stem into the humeral canal (Figure 22) impacting if necessary.

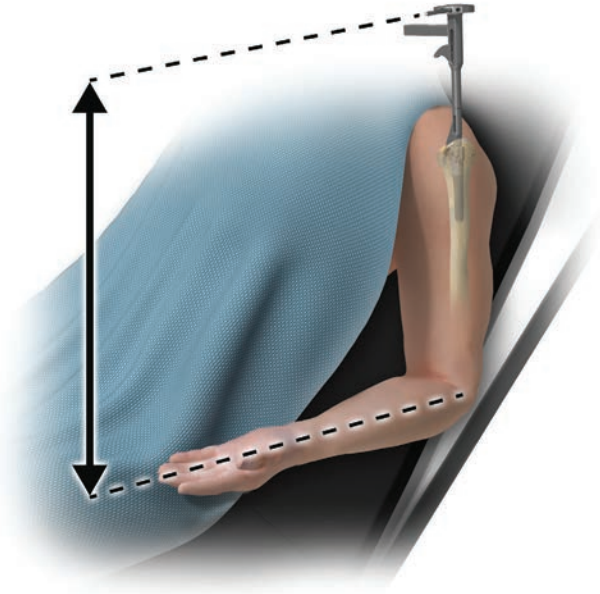

Figure 23



Figure 24

## Humeral Stem Insertion – Cemented Technique

Attach the broach handle to the broach/trial, and remove it from the humeral canal. Select a humeral stem 2 mm smaller than the final broach/trial used. Assemble the humeral stem onto the humeral stem inserter. Use a pulse lavage/suction unit to thoroughly clean the humeral canal. Dry the canal with absorbent gauze and inject doughy cement in a retrograde manner, completely filling the humeral canal. Place the version control rod into the appropriate version hole and align it with the forearm flexed at 90 degrees (Figure 23).

Introduce the implant into the humeral canal (Figure 24), keeping the alignment rod in line with the forearm, until the desired position is attained. Remove excess cement.



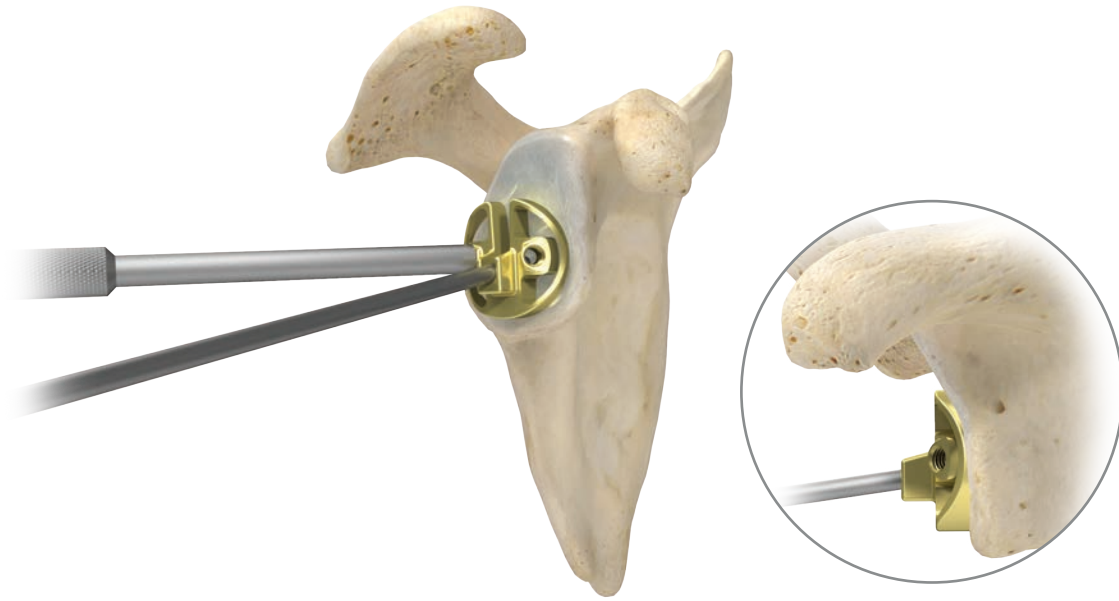

Figure 25

## Glenoid

There are two baseplate options (Mini and Standard) available, each with specific instrumentation. For a breakdown of these instruments, refer to the tray layouts beginning on page 40.

### Glenoid Preparation

Attach the threaded glenoid guide handle to the glenoid sizer. Insert a 3.2 mm Steinmann pin into the glenoid at the desired angle and position, ensuring the pin engages or perforates the medial cortical wall (Figure 25). A completely secure Steinmann pin is essential to ensure the subsequent reamer has a stable cannula over which to ream. A 10 degree inferior tilt has been built into the glenoid sizer, however any glenoid defects or asymmetric wear needs to be accounted for when the Steinmann pin is placed correctly within the guide, it will lie flush with the inferior groove.

Ideally, the Steinmann pin should be placed into the best possible bone stock, keeping in mind the Versa-Dial® glenosphere can be offset up to 4.5 mm in any direction.\* It may be helpful to section off the glenoid into quadrants for ease of placement of the Steinmann pin, as the best bone is often located centrally.

\*For the 36 mm standard glenosphere, the offset range is 1.5–3.5 mm.

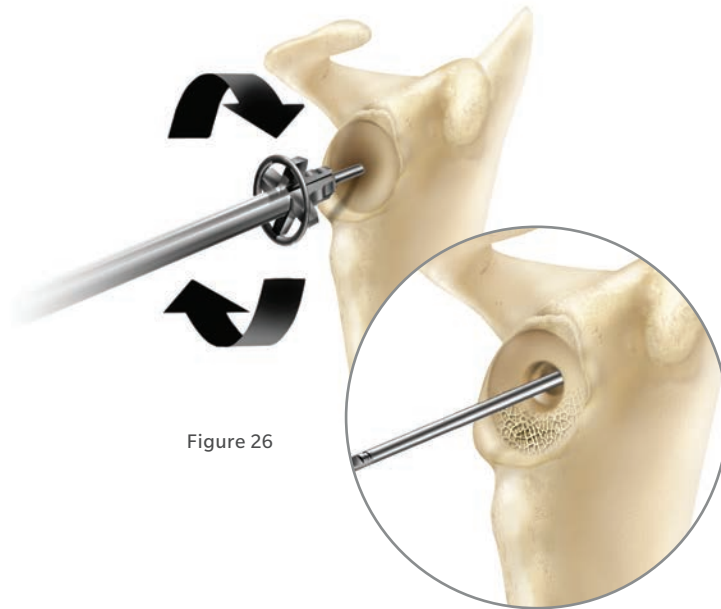

Figure 26

Figure 26a

## Glenoid (cont.)

⊖ **Note:** Obtaining a pre-operative CT scan will help identify bone erosion which may affect glenoid tilt and/ or version. It also helps locate quality bone in which to place the baseplate.

Position the cannulated baseplate reamer over the top of the Steinmann pin (Figure 26). Ream the glenoid to the desired level, ensuring the medial geometry of the glenoid baseplate is completely reamed. Due to the 10 degree inferior tilt of the Steinmann pin sizer, an inferior ridge should be evident first. A slight superior bone ridge should then follow, ensuring full concentric reaming. It is common to see cancellous bone inferiorly, while cortical bone remains superiorly. It is critical that the glenoid is adequately reamed to ensure complete seating of the glenoid baseplate (Figure 26a). Depending on the condition of the glenoid, the baseplate can be partially counter-sunk. This is accomplished by sinking the glenoid reamer until the desired inferior bone shelf is evident.

Remove the cannulated glenoid reamer, ensuring the Steinmann pin remains securely positioned in the glenoid (Figure 26a). If the Steinmann pin comes out, the baseplate trial can be used to reposition and place the Steinmann pin into the glenoid.

⊖ **Note:** There is not a stop on the glenoid reamer, so continual attention to the reaming depth is important.



Figure 27



Figure 28

## Glenoid (cont.)

It is critical to remove any excess bone and soft tissue from the glenoid face (typically inferior) that may prevent complete impaction of the glenosphere/taper assembly into the baseplate. This can be done with two different methods.

**Method 1:** Using the cannulated trial glenoid baseplate, position the glenoid baseplate provisional over the Steinmann pin and into the prepared glenoid. If there appears to be any bone and/or soft tissue that extends past the face of the trial glenoid baseplate, utilize a rongeur to trim this unwanted bone down to ensure complete seating of the glenosphere (Figure 27).

**Method 2:** If the instrumentation that features the calcar planer is available, select and attach the appropriate planer blade based on the size of glenosphere desired to the planer. Position the cannulated glenoid planer over the top of the Steinmann pin. Concentrically plane the glenoid face, ensuring any adhesions and soft tissues are removed from the face of the glenoid (Figure 28). Remove the cannulated glenoid planer, ensuring that the Steinmann pin remains securely positioned in the glenoid.

If additional bone or soft tissue are present on the inferior shelf or the included planer is too large to insert into the joint space, utilize a rongeur to trim unwanted bone to ensure complete seating of the glenosphere. If the glenoid baseplate provisional does not fully seat in either of these methods, the baseplate reamer should be used to completely prepare the baseplate geometry.

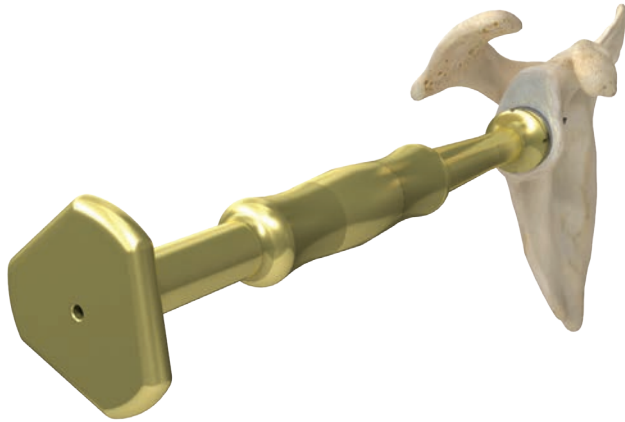

Figure 29

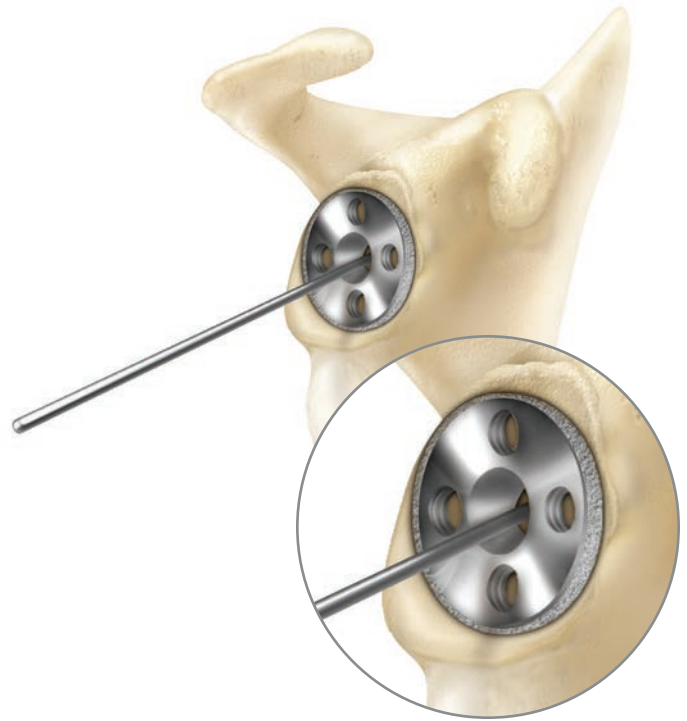

Figure 30

## Glenoid (cont.)

### Baseplate Impaction

Application of saline or other appropriate lubrication to impactor tip o-ring should aid in distraction of impactor from baseplate after impaction. Place the glenoid baseplate implant onto the end of the cannulated baseplate impactor (Figure 29). Reference the screw hole indicator hashmarks and grooves on the impactor to align the peripheral hole screw position as desired. All peripheral screw holes on the baseplate are identical, which allows them to be placed in any desired location. Once aligned, impact the baseplate into the glenoid and remove the baseplate impactor. The back of the baseplate should be fully seated on the face of the glenoid surface. Visual confirmation can be attained by checking for gaps between the reamed glenoid surface and baseplate at the screw holes. A small nerve hook may aid in confirming complete seating of the baseplate. Due to the 10 degree inferior to superior orientation for the baseplate preparation, the baseplate may be partially or fully counter-sunk inferiorly.

The glenoid baseplate is now seated, and determination of the appropriate length 6.5 mm central screw can be made (Figure 30).

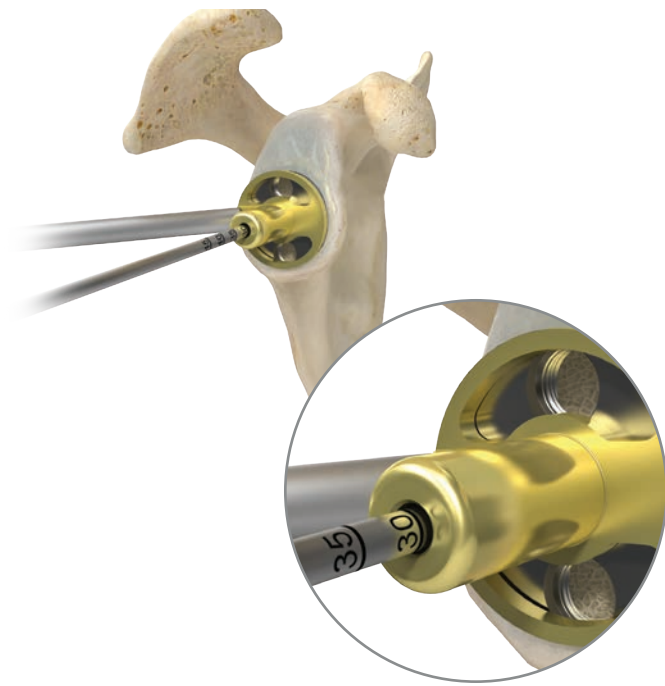

Figure 31

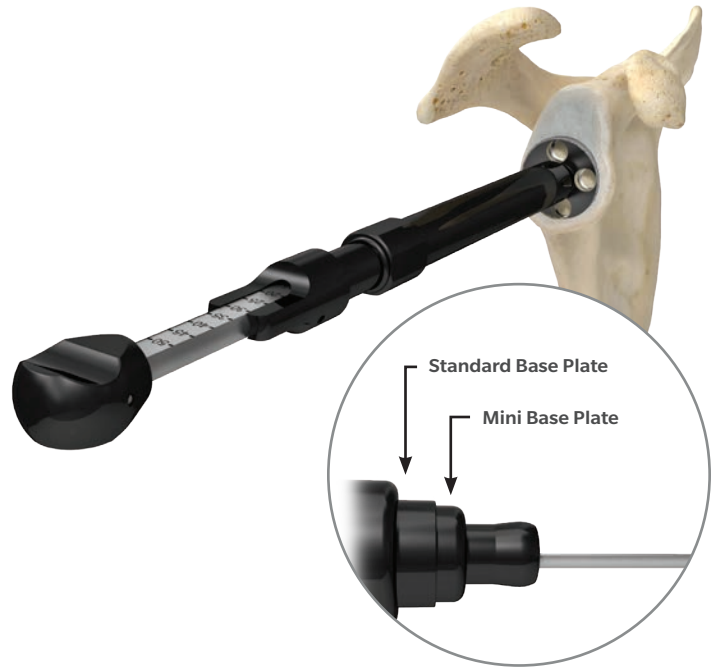

Figure 32

## Glenoid (cont.)

### Baseplate Central Screw Selection/Insertion

6.5 mm central screw length determination may be made in one of the three following methods:

1. With Steinmann pin in place, position the central screw drill guide over the pin and read the corresponding depth marking on the pin from the back of the drill guide (Figure 31).
2. If Steinmann pin is removed or falls out, insert the central screw drill guide into the glenoid baseplate and drill a 3.2 mm diameter hole to the desired depth. Read corresponding depth marking on the 3.2 mm diameter drill from the back of the drill guide (Figure 31).
3. If Steinmann pin is removed or falls out, place the depth gauge (110025762, 405829) into the reverse Morse central taper of the glenoid baseplate and read the corresponding depth marking from the gauge (Figure 32).

ⓘ **Note:** 110025762 measures screw depth for the mini baseplate central screw, standard baseplate central screw and peripheral screws for both the mini and standard baseplates.



Figure 33

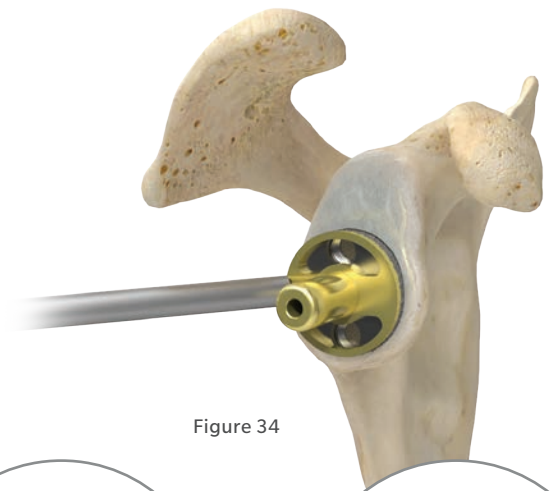

Figure 34

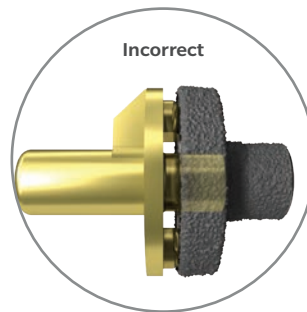

Figure 34b

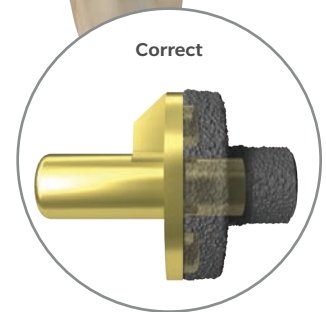

Figure 34a

## Glenoid (cont.)

Insert the desired length 6.5 mm central screw (Figure 33) and completely tighten with the 3.5 mm hex driver. To verify the 6.5 mm central screw is fully seated in the baseplate, a check with the central screw drill guide should be performed. Simply attach the central screw drill guide/ template to the guide handle, and insert the guide into the reverse Morse taper of the baseplate (Figure 34). If the guide sits flush on the baseplate without rocking or toggling, the central screw is completely and correctly seated (Figure 34a & 34b).

If the guide does not sit flush, the central screw is not completely tightened. Additional effort should be made to inspect for unwanted soft tissue or debris behind the screw head; then fully seat the central screw. A fully seated central screw provides the best compression and fixation, as well as ensures the male taper of the glenosphere will fully engage.

**Tip:** The most common lengths of the central screw are 25 – 35 mm.

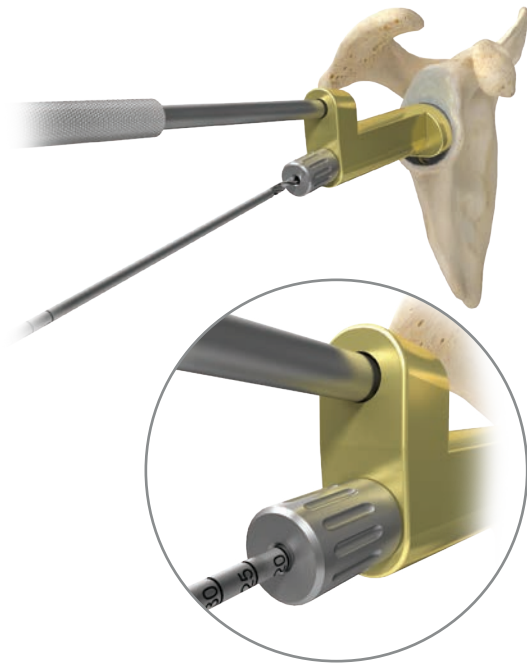

Figure 35



Figure 36

## Glenoid (cont.)

### Peripheral Screw Selection/Insertion Method 1: Fixed Angle Only

Position the peripheral drill guide with bushing insert on the baseplate and drill the superior hole using 2.7 mm drill (Figure 35).

Ensure the drill bushing is flush with the guide when reading the depth markings off of the drill. Remove the drill bushing insert from the guide.

Select and tighten the appropriate length 4.75 mm screw through the channel in the drill guide using the 3.5 mm hex driver, and into the baseplate without completely tightening (Figure 36). Rotate the peripheral drill guide and bushing 180 degrees and repeat for opposing screw. Repeat these steps for the remaining two peripheral screws.

**Warning:** It is important to ensure the screw driver and screw are parallel with each other and fully engaged as you insert the screws using the included ratchet handle and driver. Do not insert screws under power. Deviation from this technique may lead to stripping of the driver and screw interface. Once the screws are fully seated in the baseplate, do not over-tighten.

**Note:** It is advisable to inspect all screw drivers after each surgery and replace as necessary.

Tighten all peripheral locking screws in an alternating fashion until fully seated to complete baseplate screw insertion (Figure 37).





Figure 37

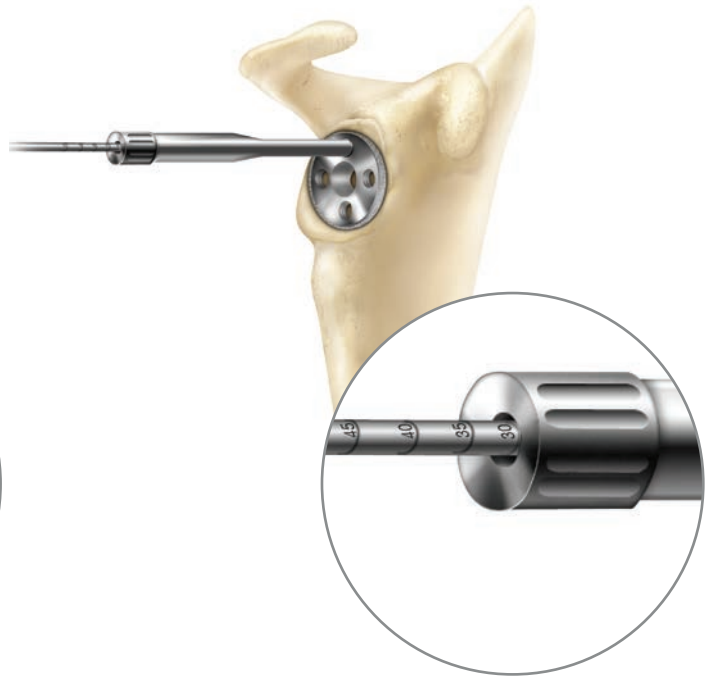

Figure 38

## Glenoid (cont.)

**Tip:** The most common lengths of superior and inferior screws are 25 – 35 mm. The most common length of anterior and posterior screws is 15 mm. Typically, locking screws are used for all peripheral holes. However, the non-locking screws may be used to obtain compression and variability in the screw angle.

ⓘ **Note:** When used with locking screws, the baseplates peripheral holes are fixed at a 5 degree diverging angle.

ⓘ **Note:** A yellow mark has been added to the 3.5 mm hex driver to indicate when the screw is approaching the baseplate threads (when used with the captured peripheral drill / screw guide). As the yellow mark begins to disappear into the captured peripheral drill / screw guide, the screw threads are approximately 2.5 mm from completely seating. When the yellow mark can no longer be seen, the threads on the head of the screw are within approximately one complete turn of seating in the baseplate.

ⓘ **Note:** The text written on the Zimmer-Hudson connection (3.5 mm hex or 2.5 mm hex) of the peripheral drivers should be used to visually identify the type of driver.

### Peripheral Screw Selection/Insertion Method 2: Fixed Angle and Variable Angle

As an alternative to using the peripheral drill guide with bushing insert, the peripheral drill guides (fixed angle or variable angle) which thread into each baseplate peripheral hole may be used. The threaded peripheral drill guide is threaded into the baseplate (Figure 38). With the 2.7 mm peripheral drill bit, drill the superior hole and read the desired depth marking at the end of the drill guide. Unscrew the threaded peripheral drill guide from the baseplate, and insert the appropriate peripheral screw. Repeat until all four peripheral screws are inserted, and fully tighten in an alternating fashion.



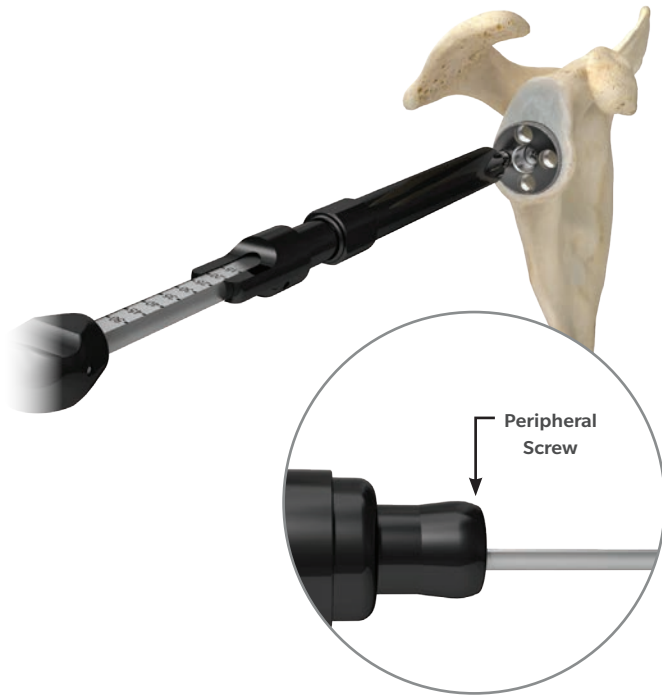

Figure 39

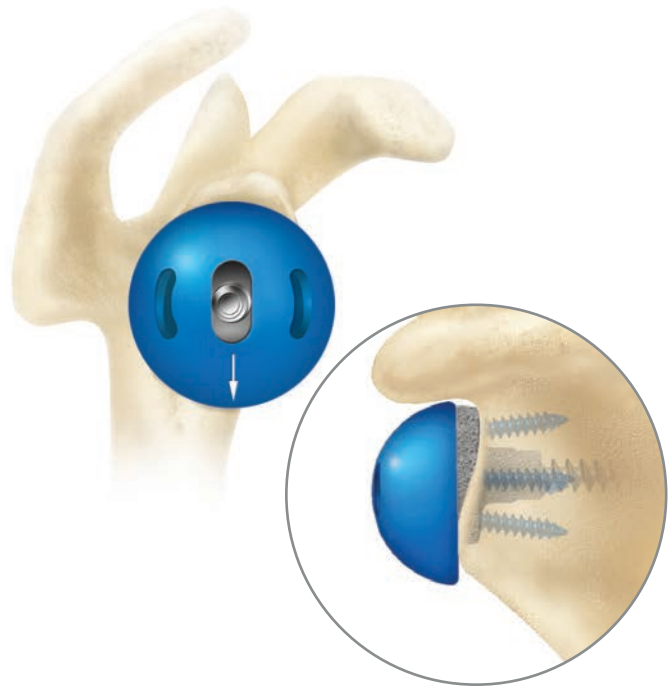

Figure 40

## Glenoid (cont.)

- ⓘ **Note:** If using the variable-angle threaded peripheral drill guide, the non-locking 4.75 mm peripheral screw must be used. Six degrees of angulation in any direction is possible.
- ⓘ **Note:** If using the fixed-angle threaded peripheral drill guide, either the locking or non-locking 4.75 mm peripheral screws may be used.
- ⓘ **Note:** 110025762 measures screw depth for the mini baseplate central screw, standard baseplate central screw and peripheral screws for both the mini and standard baseplates.

## Glenosphere Selection

Select the appropriately sized glenosphere trial and assemble to a trial taper adaptor. Determine the amount and orientation of glenosphere offset, keeping in mind that a fully inferior offset glenosphere provides the best opportunity to minimize or eliminate scapular notching (Figure 40). However, it is possible to orient the glenosphere offset in any direction including anterior/ posterior, which may help with instability. Glenosphere provisionals are marked with an arrow to show offset direction.

In addition to the amount and direction of offset, medialized or lateralized center of rotation glenospheres (+3 mm, +6 mm) are available depending on preference.

**Tip:** The most common glenospheres used are 36 mm.

Glenospheres are offered in 40mm and 41mm sizes as well.



Figure 41

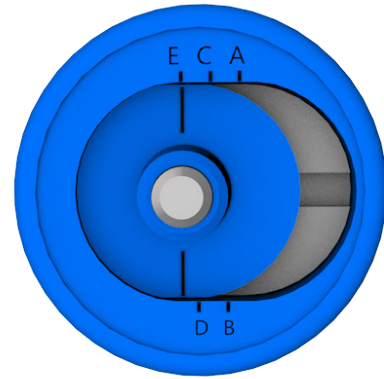

Figure 42

## Glenoid (cont.)

After desired positioning of glenosphere trial is achieved, tighten the taper adaptor trial in the head trial with the appropriate hex driver (Figure 41).

- ⓘ **Note:** It may be helpful to use the trial glenosphere wrench for insertion and rotation of the trial glenosphere.
- ⓘ **Note:** An optional glenosphere trial inserter exists to be used in conjunction with the slots located on the articulating surface of the glenosphere trial to aid in the removal of the trial.

## Glenosphere Offset

Remove the glenosphere trial assembly from the glenoid baseplate. Determine the amount of offset needed by referencing the A, B, C, D, and E \* indications on the underside of the trial glenosphere and trial adaptor (Figure 42). This offset indicator will be referenced when preparing the definitive implant.

- ⓘ **Note:** The glenosphere removal fork may be required to remove the trial glenosphere from the glenoid baseplate.
- ⓘ **Note:** The glenosphere offset may be positioned in any orientation relative to the glenoid baseplate, keeping in mind that an inferior offset provides the best opportunity to minimize scapular notching.

\*The 36 mm standard glenosphere provisional is marked with B, C, D indications as the offset range is 1.5 mm to 3.5 mm for the definitive implant.



Figure 43



Figure 43a



Figure 44



Figure 44a

## Glenoid (cont.)

### Glenosphere Assembly

Place the glenosphere implant into the impactor base (110027886 or 407281). Ensuring the components are clean and dry, insert the taper adaptor into the glenosphere (Figure 43a & 44a). Rotate the taper adaptor until the trial offset is replicated. For example, if trialing indicated a fully offset glenosphere (position E), the implant taper adaptor is aligned so that the hashmark is positioned at position E on the definitive glenosphere head (Inset).

Offset Indicator	Offset*
A	0.5 mm
B	1.5 mm
C	2.5 mm
D	3.5 mm
E	4.5 mm

Engage the Morse taper with two firm strikes, using the taper impactor tool (407280 or 110029132) and mallet (Figure 43 and 44). The taper/ glenosphere assembly is now secure.

**Note:** In the event the taper has been engaged in an incorrect position, the Versa-Dial taper extractor (407298), located in the humeral preparation tray, may be used to remove the taper adaptor from the glenosphere. After removal of the taper adaptor, a new taper adaptor should be used.

\*For 36 mm Standard Glenosphere, the offset range is 1.5–3.5 mm (B–D).

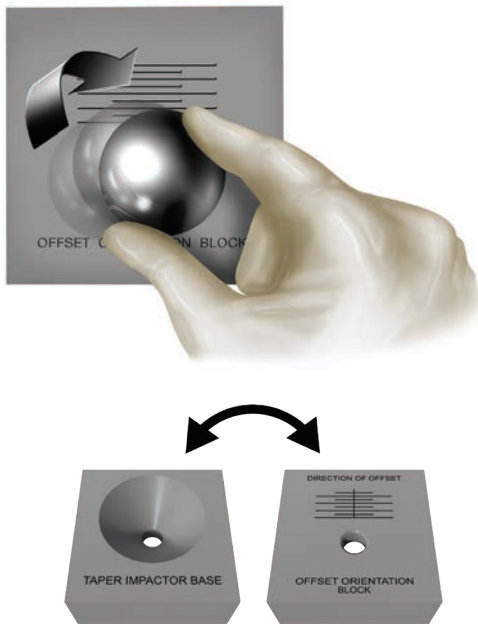

Figure 45



Figure 46

## Glenoid (cont.)

### Glenosphere/Taper Adaptor Offset Direction Determination

Place the glenosphere into the orientation block (110027886 or 407281) for determination of offset direction. Rotate the glenosphere until the implant reaches the point that is furthest on the orientation block scale. This orientation will represent the direction of maximum offset (Figure 45).

Slide the 2-prong glenosphere inserter/impactor onto the glenosphere and tighten. Another option is to place the glenosphere forceps over the top of the glenosphere and tighten using a ratcheting mechanism (Figure 46).

As an alternative to the glenosphere inserter, a surgical marker can be used to note the direction of the offset on the rim of the glenosphere. The glenosphere can then be inserted into the baseplate by hand.

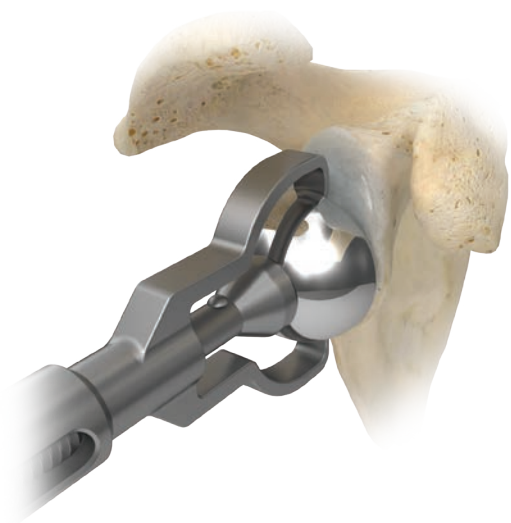

Figure 47



Figure 48

## Glenoid (cont.)

### Glenosphere Orientation / Impaction

Once the reverse Morse taper of the baseplate has been cleaned and dried, engage the glenosphere using the forceps, and implant the glenosphere in the same orientation as the trial (Figure 47). If using the 2-prong glenosphere inserter, you may strike the end of the instrument to engage the glenosphere and taper assembly into the baseplate. If using the 4-prong forceps inserter, it is recommended to hold the glenosphere while it is positioned within the baseplate. With two firm strikes, the concave glenosphere impactor (407280 or 110029132) should be used to engage the glenosphere into the baseplate. A screw is not needed to attach the glenosphere to the baseplate. The design of the Morse tapers provide secure fixation.

## Humeral Tray and Bearing

### Humeral Tray and Bearing Preparation

Select the appropriately sized one-piece trial humeral tray/ bearing. Noting the “SUPERIOR” and “INFERIOR” markings on the humeral tray, place the trial humeral tray/bearing into the Comprehensive broach/trial (Figure 48) and perform a trial reduction to assess range of motion and implant size selection. The included shoe horn may be helpful in reducing the joint. The trial reduction should show very limited distraction (1 mm or less).

ⓘ **Note:** The trial humeral tray/bearing will not engage the broach/stem if the broach/stem is counter-sunk and/or does not match the version/inclination of the humeral cut. If the broach/stem is counter-sunk and/or does not match the humeral cut version/inclination, re-position the broach/stem higher or remove the appropriate amount of bone in order for the trial humeral tray/bearing to seat.

ⓘ **Note:** Mini Humeral Tray and Bearing Provisionals can also be used with this system. Please refer to Surgical Technique Addendum for Mini Humeral Tray: 1998.1-GLBL



Figure 49

## Humeral Tray and Bearing (cont.)

- ⓘ **Note:** In cases of extreme instability, +3 mm retentive humeral bearings are available. Retentive bearings capture more of the glenosphere and have polyethylene walls which are 2– 3 mm higher than standard +3 mm bearings, but do not add any additional joint space. Depending on variations in instrument tray layouts, the retentive bearings may be found in the revision instrument tray.
- ⓘ **Note:** Additional humeral resection and subsequent re-reaming and re-broaching may be required if the joint is extremely difficult to reduce.
- ⓘ **Note:** Glenospheres and humeral bearings have been color coded to ensure only matching curvatures are used together.

**Tip:** The most common thickness of the tray and bearing is standard for each (STD-STD).

## Humeral Tray and Bearing Assembly

Utilize the bearing assembly tool to first spread the RingLoc® locking mechanism to the open position by fully seating the bearing assembly tool on the humeral tray. An audible “click” will be heard when the bearing assembly tool is properly engaged. Next, place the engaged bearing assembly tool and humeral tray on the glenosphere offset orientation block. Position the definitive humeral bearing in the definitive humeral tray, ensuring that the laser etching on the bearing aligns with the laser etching on the humeral tray. Using the humeral bearing/tray impactor tool, apply downward pressure to the bearing and remove the bearing assembly tool continuing to apply downward pressure on the bearing. With two firm strikes of the humeral tray/ bearing impactor (405825 or 110028055), impact the humeral bearing into the humeral tray (Figure 49). Following inspection, ensure the humeral bearing is fully seated within the humeral tray.

- ⓘ **Note:** Mini Humeral Tray and Bearing Implants can also be used with this system. Please refer to Surgical Technique Addendum for Mini Humeral Tray: 1998.1-GLBL



Figure 50

## Humeral Tray and Bearing (cont.)

### Humeral Tray/Bearing Impaction

Clean and dry the reverse Morse taper of the stem. With two firm strikes of the humeral tray/ bearing impactor, impact the assembled definitive humeral tray/bearing into the Comprehensive stem. The humeral tray is marked "SUPERIOR" to aid in positioning the tray/bearing with respect to the stem. When inserted correctly, the thicker portion of the polyethylene bearing should be inferior. Reduce the joint with the aid of the shoe horn and assess the final range of motion. The final reduction (Figure 50) should show very limited distraction (1 mm or less). Impingement should not be present in either adduction or abduction. If impingement occurs in abduction, a greater tuberosity osteotomy or tuberoplasty may be necessary.

### Subscapularis Repair

There is some evidence that the subscapularis improves the stability of the implant. Therefore, when possible, the subscapularis should be repaired at the completion of the procedure, as long as it does not significantly reduce external rotation. If the tissue at the lesser tuberosity is poor, place sutures through the bone prior to implantation of the stem.



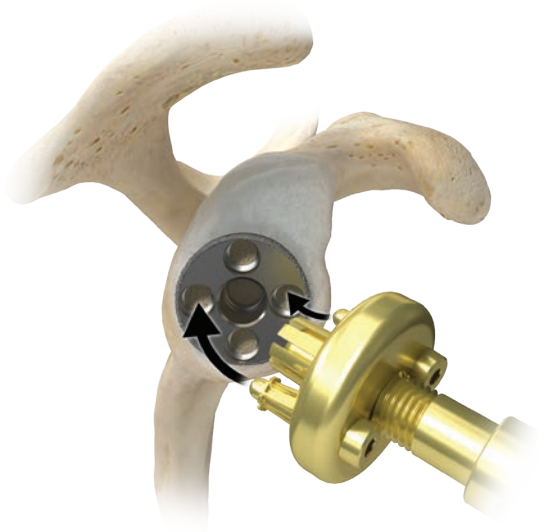

Figure 51



Figure 52

## Revision Options

Depending on variations in instrument tray layouts, revision instruments may be found in the revision instrument tray.

### Removal of Glenosphere/Baseplate

Remove the Versa-Dial glenosphere with the low-profile head removal fork. Once the glenosphere is removed, the peripheral and central screws should be removed with the appropriate size hex driver.

The baseplate should be completely removed by first positioning the two peripheral collets of the baseplate extractor into the opposing holes in the glenoid baseplate and fully tightening (using the 2.5 mm hex driver) and secondary, inserting the threaded shaft into the central portion of the baseplate extractor and turning clockwise with the included extraction bar. This will expand the collet located at the end of the baseplate extractor (Figure 52). Once secure, a slap-hammer can be used to fully remove the baseplate. It may be desirable to use autograft/allograft material on the glenoid at this time, before proceeding to complete the salvage hemi-arthroplasty.

### Polyethylene Preparation

After gaining access to the implanted glenoid, section off the three peripheral pegs by making three cuts in a triangular fashion around the central peg using an oscillating saw (Figure 52).

This will allow the removal of the outer portion of the polyethylene glenoid independently from the central portion.

### Polyethylene Removal

Using a thin osteotome or rongeur, remove the outer portion of the polyethylene glenoid, including the cemented peripheral pegs (Figure 52)

The central portion of the polyethylene can then be unthreaded from the well-fixed polyethylene or Regenerex central post.



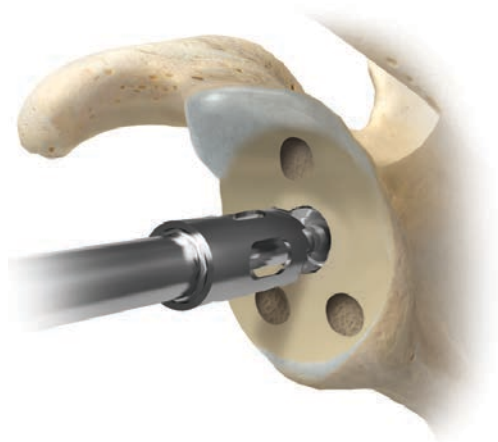

Figure 53

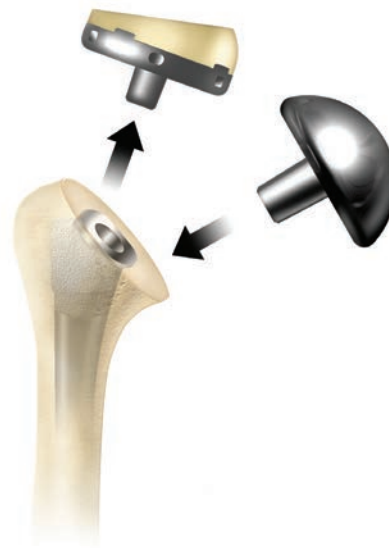

Figure 54

## Central Post Removal

Thread the guide rod onto the central post. Using the guide rod as a cannula, proceed to cut down over the central post using the trephine (Figure 53). Once the trephine has bottomed out on the central post, remove the trephine from the joint. The guide rod can now be used to remove the central post.

- ⓘ **Note:** This technique and instrumentation can be used with either previously implanted Polyethylene or Regenerex central post.
- ⓘ **Note:** The outer diameter of the trephine is smaller than the outer diameter of the Reverse Standard Baseplate central boss and equal to the outside diameter of the Reverse Mini Baseplate. This will leave enough glenoid bone for the Comprehensive Reverse Baseplate Reamer to achieve cancellous reaming.
- ⓘ **Note:** When considering which reverse baseplate to use on a revision, consider that there will be more interference fit on the standard baseplate as compared to the mini baseplate. This is due to the dimension of the boss being larger on the standard baseplate.

## Salvage Hemi-arthroplasty

In the event a Comprehensive Reverse Shoulder fails, a salvage hemi-arthroplasty may be the only option for a patient. A salvage reverse to hemi-arthroplasty conversion may be accomplished without removing a Comprehensive stem.

## Removal of the Humeral Tray/Bearing

The humeral tray/bearing assembly may be removed with the low-profile removal fork. As the humeral tray sits very near the resected surface of the humerus and the stem collar lies within the counter-bore geometry of the humeral tray, it is preferable to place one of the removal fork arms between the humeral tray and stem collar, which will act as a wedge and disengage the taper from the stem. Once the humeral tray/bearing assembly is removed and the stem taper has been cleaned and dried, a large Versa-Dial or EAS humeral head may be inserted and engaged into the Comprehensive stem (Figure 54).



Figure 55



Figure 55a



Fracture Stem

Revision Stem

Figure 56

## Central Post Removal (cont.)

ⓘ **Note:** Utilize part #407389 to remove the titanium humeral tray/bearing assembly. Utilize part #406920 to remove the cobalt chrome humeral tray/bearing assembly. The cobalt chrome tray has removal slots that fit the low-profile removal fork for easier removal in an anterior/posterior direction.

### Polyethylene Humeral Bearing Removal/Exchange

If a humeral bearing needs to be replaced, the RingLoc locking mechanism of the humeral tray will allow for exchange/revision of bearings without tray removal (Figure 55). To remove a humeral bearing, simply expand the locking ring using the Ringloc liner removal tool. Position the curved portion of the tip towards the bearing and insert between the open portion of the locking ring. This will expand the ring. Once the ring has been expanded, slide the removal tool down and then underneath the bearing. The humeral bearing is now released.

When a bearing is removed, a new locking ring (size 21, #106021) should be placed into the humeral tray before the new bearing is locked in place. A correctly positioned locking ring should open towards the superior portion of the humeral tray as shown in (Figure 55a).

## Other Stem Options

The Comprehensive Fracture and Revision stems (Figure 56) are compatible with the Comprehensive Reverse Shoulder. For the complete Comprehensive Fracture Stem Technique, please see BOI0274.0.

ⓘ **Note:** Revision broaches are available for order. Flexible hip reamers can be used in conjunction with the revision length broaches in order to prepare the distal humeral canal. Standard humeral reamers should be used to prepare for the proximal stem geometry. Similar to the standard length stem, ream so that the etched line is even with the greater tuberosity.

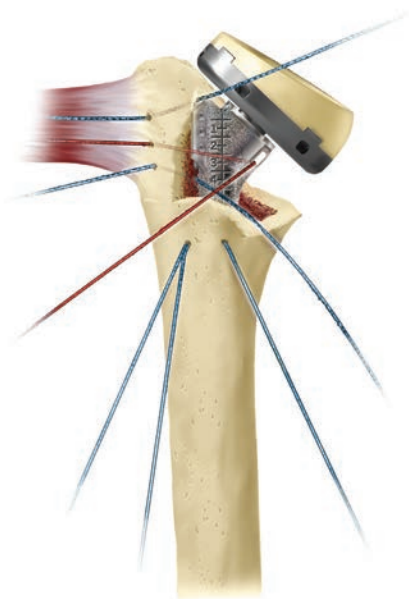

Figure 57

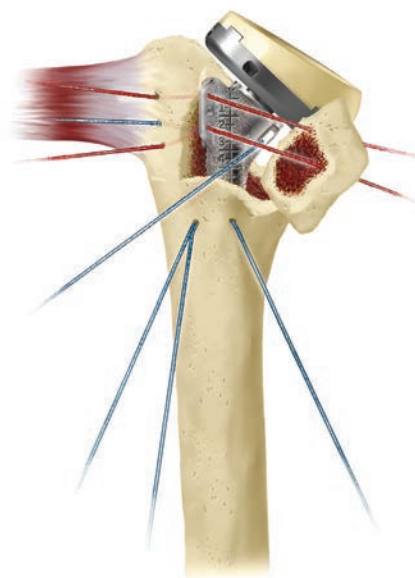

Figure 58

## Fracture: Tuberosity Reconstruction

Tuberosity reconstruction is just as important in Reverse Total Shoulder Arthroplasty for fracture as it is Hemi Arthroplasty for fracture of the proximal humerus. The procedure is similar in both procedures and involves longitudinal and transverse fixation of the tuberosities to the humeral shaft and themselves around and/or through the implant.

### Proximal Humerus Fractures

There are many acceptable variations, including using the humeral tray suture slots for reconstruction of the tuberosities. However, the goal is to securely fix the greater and lesser tuberosities to the shaft and to each other. Tuberosity clamps can be used to secure tuberosities during reconstruction.

Place three #5 nonabsorbable sutures through the bone tendon interface of the greater tuberosity. Place the middle greater tuberosity suture through the suture hole on the medial neck of the prosthesis (Figure 57).

Next, place the superior and inferior greater tuberosity sutures through the superior and inferior holes in the prosthesis fin. Continue with these sutures through the bone tendon interface of the lesser tuberosity at corresponding levels (Figure 58).

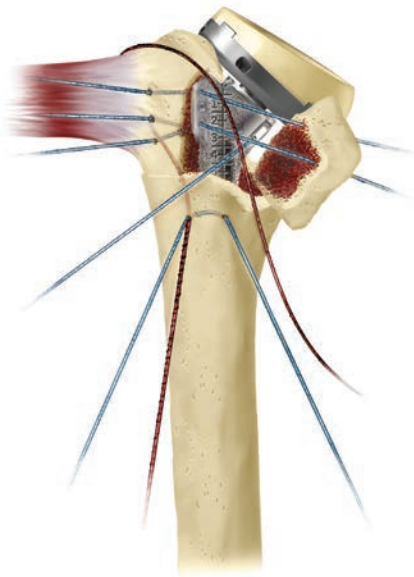

Figure 59

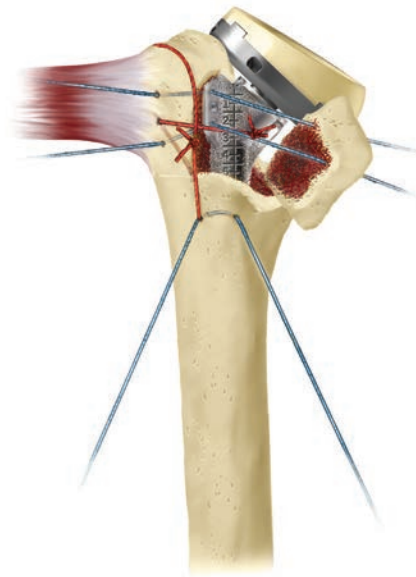

Figure 60

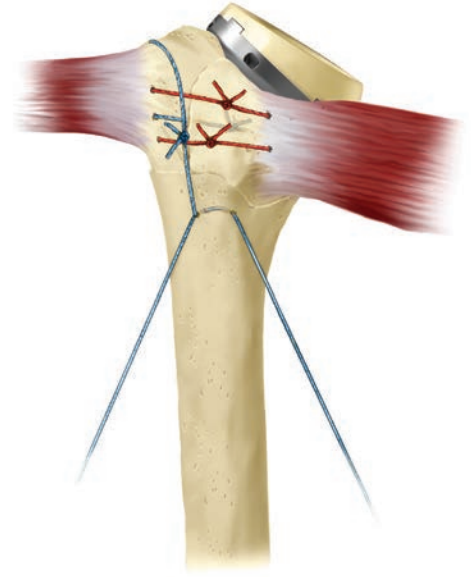

Figure 61

## Fracture: Tuberosity Reconstruction (cont.)

Pass the longitudinal suture, previously placed through the lateral hole in the humeral shaft, above the greater tuberosity. Continue with this suture underneath the greater tuberosity sutures (Figure 59).

Tie these sutures in the appropriate order to first secure the greater tuberosity to the humeral shaft and to the prosthesis (Figure 60) and then to secure the lesser tuberosity to the humeral shaft and to the greater tuberosity (Figure 61).

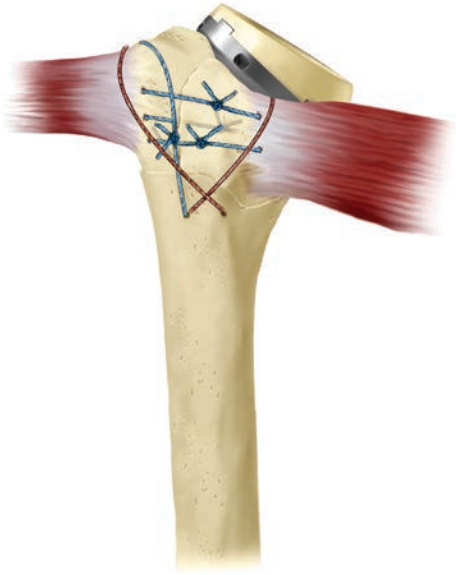

Figure 62

## Fracture: Tuberosity Reconstruction (cont.)

Place the figure-of-eight suture that was placed prior to stem insertion from back to front through the rotator cuff and close above the tuberosities, fixing the tuberosities to the humeral shaft (Figure 62). If a primary reverse arthroplasty for proximal humeral fracture is being performed, insert bone graft from the humeral head below the tuberosities. Improper positioning of the tuberosity may cause abnormal tensioning on any remaining rotator cuff tendons and could lead to impingement. Place the shoulder through a range of motion, noting stability of the tuberosities. This will allow guidance for the postoperative rehabilitation program.

## Humeral Stem Sizing

### Standard Stem

Last Reamer Used	Broach to Size	Implant Size
20 STD / 19 MI	20 mm	20 mm
19 STD / 18 MI	19 mm	19 mm
18 STD / 17 MI	18 mm	18 mm
17 STD / 16 MI	17 mm	17 mm
16 STD / 15 MI	16 mm	16 mm
15 STD / 14 MI	15 mm	15 mm
14 STD / 13 MI	14 mm	14 mm
13 STD / 12 MI	13 mm	13 mm
12 STD / 11 MI	12 mm	12 mm
11 STD / 10 MI	11 mm	11 mm
10 STD / 9 MI	10 mm	10 mm
9 STD / 8 MI	9 mm	9 mm
8 STD / 7 MI	8 mm	8 mm
7 STD / 6 MI	7 mm	7 mm
6 STD / 5 MI	6 mm	6 mm
5 STD / 4 MI**	5 mm	5 mm
4 STD**	4 mm	4 mm
4 STD**	4 mm	4 mm

\*\*Since there are no numeric hashmarks on the teeth of these reamers, ream to the horizontal hashmark.

### Mini Stem

Last Reamer Used	Broach to Size	Implant Size
20 STD / 19 MI*	20 mm	20 mm
20 STD / 19 MI	19 mm	19 mm
19 STD / 18 MI	18 mm	18 mm
18 STD / 17 MI	17 mm	17 mm
17 STD / 16 MI	16 mm	16 mm
16 STD / 15 MI	15 mm	15 mm
15 STD / 14 MI	14 mm	14 mm
14 STD / 13 MI	13 mm	13 mm
13 STD / 12 MI	12 mm	12 mm
12 STD / 11 MI	11 mm	11 mm
11 STD / 10 MI	10 mm	10 mm
10 STD / 9 MI	9 mm	9 mm
9 STD / 8 MI	8 mm	8 mm
8 STD / 7 MI	7 mm	7 mm
7 STD / 6 MI	6 mm	6 mm
6 STD / 5 MI	5 mm	5 mm
5 STD / 4 MI**	5 mm	5 mm
4 STD**	4 mm	4 mm

\*Ream to horizontal hashmark in order to implant the 20 mm mini stem, as there is not a larger reamer to facilitate reaming to a point between the 3 and 4 hashmark.

\*\*Since there are no numeric hashmarks on the teeth of these reamers, ream to the horizontal hashmark.

## Humeral Stem Sizing (cont.)

### Micro Stem

Last Reamer Used	Broach to Size	Implant Size
20 Micro	20 mm	20 mm
19 Micro	19 mm	19 mm
18 Micro	18 mm	18 mm
17 Micro	17 mm	17 mm
16 Micro	16 mm	16 mm
15 Micro	15 mm	15 mm
14 Micro	14 mm	14 mm
13 Micro	13 mm	13 mm
12 Micro	12 mm	12 mm
11 Micro	11 mm	11 mm
10 Micro	10 mm	10 mm
9 Micro	9 mm	9 mm
8 Micro	8 mm	8 mm
7 Micro	7 mm	7 mm
6 Micro	6 mm	6 mm
5 Micro	5 mm	5 mm
4 Micro	4 mm	4 mm

## Comprehensive Fracture System Sizing Chart



Reamer	Bone Tap	Positioning Sleeve	Sleeve Inserter	Fracture Stem
6 mm 7 mm	6 mm 7 mm	6 mm 7 mm	6 mm or 7 mm	4 mm
8 mm 9 mm	8 mm 9 mm	8 mm 9 mm	8 mm or 9 mm	6 mm
10 mm 11 mm	10 mm 11 mm	10 mm 11 mm	10 mm or 11 mm	8 mm
12 mm 13 mm	12 mm 13 mm	12 mm 13 mm	12 mm or 13 mm	10 mm
14 mm 15 mm	14 mm 15 mm	14 mm 15 mm	14 mm or 15 mm	12 mm
16 mm 17 mm	16 mm 17 mm	16 mm 17 mm	16 mm or 17 mm	14 mm

## Implants

Product	Description	Size	Part Number
	Versa-Dial Glenosphere Standard	36 mm	115310
	Versa-Dial Glenosphere +3 mm	36 mm	115313
	Versa-Dial Glenosphere +6 mm	36 mm	115316
	Versa-Dial Glenosphere Standard	41 mm	115320
	Versa-Dial Glenosphere +3 mm	41 mm	115323
	Versa-Dial Glenosphere +6 mm	41 mm	115326
	Versa-Dial Glenosphere Standard Titanium	36 mm	TI-115310
	Versa-Dial Glenosphere +3 mm Titanium	36 mm	TI-115313
	Versa-Dial Glenosphere +6 mm Titanium	36 mm	TI-115316
	Versa-Dial Glenosphere Standard Titanium	41 mm	TI-115320
	Versa-Dial Glenosphere +3 mm Titanium	41 mm	TI-115323
	Versa-Dial Glenosphere +6 mm Titanium	41 mm	TI-115326
	Versa-Dial Taper Adaptor	—	118001
	Glenoid Baseplate	28 mm	115330
	Comprehensive Mini Baseplate and Taper Adaptor	25 mm	010000589
	Humeral Tray Standard - Titanium	44 mm	115340
	Humeral Tray +5 mm - Titanium		115345
	Humeral Tray +10 mm - Titanium		115348
	Cobalt Chrome Standard Humeral Tray	44 mm	115370
	Cobalt Chrome +5 Humeral Tray		115375
	Cobalt Chrome +10 Humeral Tray		115378
—	RingLoc Replacement Humeral Tray Ring	21	106021
	ArComXL <sup>®</sup> Standard Humeral Bearing	44–36 mm	XL-115363
	ArComXL +3 mm Humeral Bearing	44–36 mm	XL-115364
	ArComXL Retentive +3 mm Humeral Bearing	44–36 mm	XL-115365
	ArComXL Standard Humeral Bearing	44–41 mm	XL-115366
	ArComXL +3 mm Humeral Bearing	44–41 mm	XL-115367
	ArComXL Retentive +3 mm Humeral Bearing	44–41 mm	XL-115368
	E1 <sup>®</sup> Standard Humeral Bearing	44–36 mm	EP-115393
	E1 Standard +3 mm Humeral Bearing	44–36 mm	EP-115394
	E1 Retentive +3 mm Humeral Bearing	44–36 mm	EP-115395
	E1 Standard Humeral Bearing	44–41 mm	EP-115396
	E1 Standard +3 mm Humeral Bearing	44–41 mm	EP-115397
	E1 Retentive +3 mm Humeral Bearing	44–41 mm	EP-115398



## Implants (cont.)



Product	Description	Size	Implant Part No.	Broach/Trial Part No.
	Comprehensive Humeral Stem—Micro	4 mm	113604	405304
	Comprehensive Humeral Stem—Micro	5 mm	113605	405305
	Comprehensive Humeral Stem—Micro	6 mm	113606	405306
	Comprehensive Humeral Stem—Micro	7 mm	113607	405307
	Comprehensive Humeral Stem—Micro	8 mm	113608	405308
	Comprehensive Humeral Stem—Micro	9 mm	113609	405309
	Comprehensive Humeral Stem—Micro	10 mm	113610	405310
	Comprehensive Humeral Stem—Micro	11 mm	113611	405311
	Comprehensive Humeral Stem—Micro	12 mm	113612	405312
	Comprehensive Humeral Stem—Micro	13 mm	113613	405313
	Comprehensive Humeral Stem—Micro	14 mm	113614	405314
	Comprehensive Humeral Stem—Micro	15 mm	113615	405315
	Comprehensive Humeral Stem—Micro	16 mm	113616	405316
	Comprehensive Humeral Stem—Micro	17 mm	113617	405317
	Comprehensive Humeral Stem—Micro	18 mm	113618	405318
	Comprehensive Humeral Stem—Micro	19 mm	113619	405319
	Comprehensive Humeral Stem—Micro	20 mm	113620	405320
	Comprehensive Humeral Stem—Mini	4 mm	113624	407304
	Comprehensive Humeral Stem—Mini	5 mm	113625	407305
	Comprehensive Humeral Stem—Mini	6 mm	113626	407306
	Comprehensive Humeral Stem—Mini	7 mm	113627	407307
	Comprehensive Humeral Stem—Mini	8 mm	113628	407308
	Comprehensive Humeral Stem—Mini	9 mm	113629	407309
	Comprehensive Humeral Stem—Mini	10 mm	113630	407310
	Comprehensive Humeral Stem—Mini	11 mm	113631	407311
	Comprehensive Humeral Stem—Mini	12 mm	113632	407312
	Comprehensive Humeral Stem—Mini	13 mm	113633	407313
	Comprehensive Humeral Stem—Mini	14 mm	113634	407314
	Comprehensive Humeral Stem—Mini	15 mm	113635	407315
	Comprehensive Humeral Stem—Mini	16 mm	113636	407316
	Comprehensive Humeral Stem—Mini	17 mm	113637	407317
	Comprehensive Humeral Stem—Mini	18 mm*	113638	407318
	Comprehensive Humeral Stem—Mini	19 mm*	113639	407319
	Comprehensive Humeral Stem—Mini	20 mm*	113640	407320

\*Available by special order

## Implants (cont.)

Product	Description	Size	Implant Part No.	Broach/Trial Part No.
	Comprehensive Humeral Stem—Standard	4 mm	113644	407304
	Comprehensive Humeral Stem—Standard	5 mm	113645	407305
	Comprehensive Humeral Stem—Standard	6 mm	113646	407306
	Comprehensive Humeral Stem—Standard	7 mm	113647	407307
	Comprehensive Humeral Stem—Standard	8 mm	113648	407308
	Comprehensive Humeral Stem—Standard	9 mm	113649	407309
	Comprehensive Humeral Stem—Standard	10 mm	113650	407310
	Comprehensive Humeral Stem—Standard	11 mm	113651	407311
	Comprehensive Humeral Stem—Standard	12 mm	113652	407312
	Comprehensive Humeral Stem—Standard	13 mm	113653	407313
	Comprehensive Humeral Stem—Standard	14 mm	113654	407314
	Comprehensive Humeral Stem—Standard	15 mm	113655	407315
	Comprehensive Humeral Stem—Standard	16 mm	113656	407316
	Comprehensive Humeral Stem—Standard	17 mm	113657	407317
	Comprehensive Humeral Stem—Standard	18 mm*	113658	407318
Comprehensive Humeral Stem—Standard	19 mm*	113659	407319	
Comprehensive Humeral Stem—Standard	20 mm*	113660	407320	



As an alternative standard (122 mm) length broaches are available by special order.

Product	Description	Size	Implant Part No.	Broach/Trial Part No.
	Comprehensive Humeral Stem—Fracture	4 mm	11-113554	31-406904
	Comprehensive Humeral Stem—Fracture	6 mm	11-113556	31-406906
	Comprehensive Humeral Stem—Fracture	8 mm	11-113558	31-406908
	Comprehensive Humeral Stem—Fracture	10 mm	11-113560	31-406910
	Comprehensive Humeral Stem—Fracture	12 mm	11-113562	31-406912
	Comprehensive Humeral Stem—Fracture	14 mm	11-113564	31-406914
	Comprehensive Humeral Stem—Revision	4 mm	113664	407344** 407346**
	Comprehensive Humeral Stem—Revision	6 mm	113666	407348** 407350**
	Comprehensive Humeral Stem—Revision	8 mm	113668	407352** 407354**
	Comprehensive Humeral Stem—Revision	10 mm	113670	
	Comprehensive Humeral Stem—Revision	12 mm	113672	
	Comprehensive Humeral Stem—Revision	14 mm	113674	

\*Available by special order







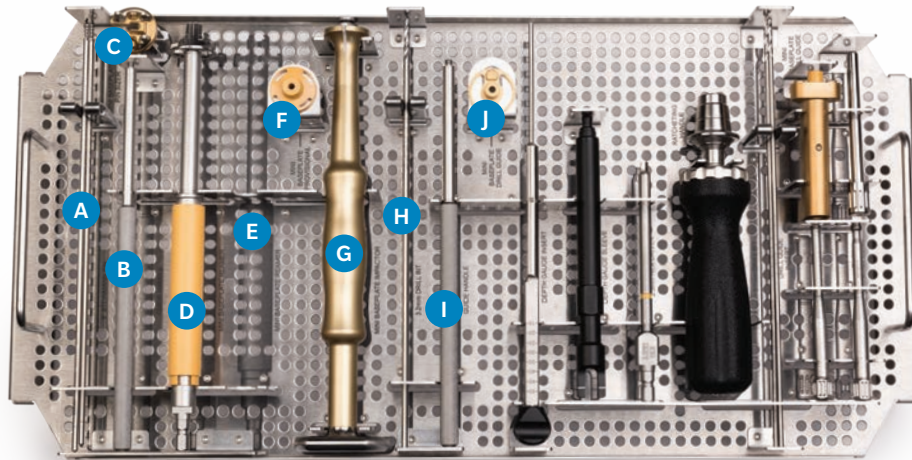

\*\*Available through loaner department

## Implants (cont.)

Product	Description	Size	Part Number
	6.5 mm Central Screw 3.5 Hex	20 mm length	115394
	6.5 mm Central Screw 3.5 Hex	25 mm length	115395
	6.5 mm Central Screw 3.5 Hex	30 mm length	115396
	6.5 mm Central Screw 3.5 Hex	35 mm length	115397
	6.5 mm Central Screw 3.5 Hex	40 mm length	115398
	6.5 mm Central Screw 3.5 Hex	45 mm length	115399
	6.5 mm Central Screw 3.5 Hex	50 mm length	115400
	4.75 mm Fixed Locking Screw 3.5 Hex	15 mm length	180550
	4.75 mm Fixed Locking Screw 3.5 Hex	20 mm length	180551
	4.75 mm Fixed Locking Screw 3.5 Hex	25 mm length	180552
	4.75 mm Fixed Locking Screw 3.5 Hex	30 mm length	180553
	4.75 mm Fixed Locking Screw 3.5 Hex	35 mm length	180554
	4.75 mm Fixed Locking Screw 3.5 Hex	40 mm length	180555
	4.75 mm Fixed Locking Screw 3.5 Hex	45 mm length	180556
	4.75 Variable Non-Locking Screw 3.5 Hex	15 mm length	180557
	4.75 Variable Non-Locking Screw 3.5 Hex	20 mm length	180558
	4.75 Variable Non-Locking Screw 3.5 Hex	25 mm length	180559
	4.75 Variable Non-Locking Screw 3.5 Hex	30 mm length	180560
	4.75 Variable Non-Locking Screw 3.5 Hex	35 mm length	180561
	4.75 Variable Non-Locking Screw 3.5 Hex	40 mm length	180562
	4.75 Variable Non-Locking Screw 3.5 Hex	45 mm length	180563







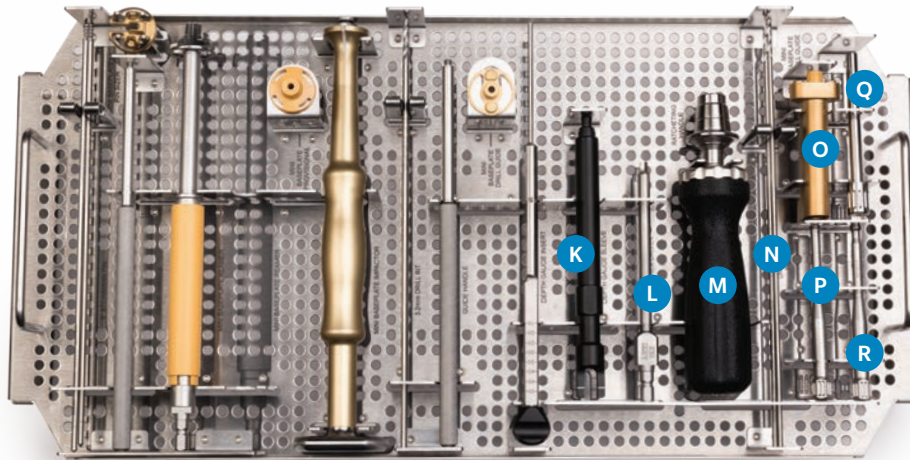



### 110028913 Comprehensive Reverse Glenoid Preparation Tray (Generation 2)

Product	Description	Label	Size	Part Number
	Steinmann Pin	A	9 in.	405800
	Glenoid Guide Handle	B, I	—	406849
	Mini Baseplate Sizer w/ 10 degree Tilt	C	—	110027742
	Mini Baseplate Reamer	D	—	110029136
—	Future Expansion	E	—	—
	Mini Baseplate Trial	F	—	406205
	Mini Baseplate Impactor	G	—	405809
	Central Screw Drill	H	3.2 mm Ø	405883
	Mini Baseplate Central Screw Drill Guide	J	3.2 mm Ø	406206







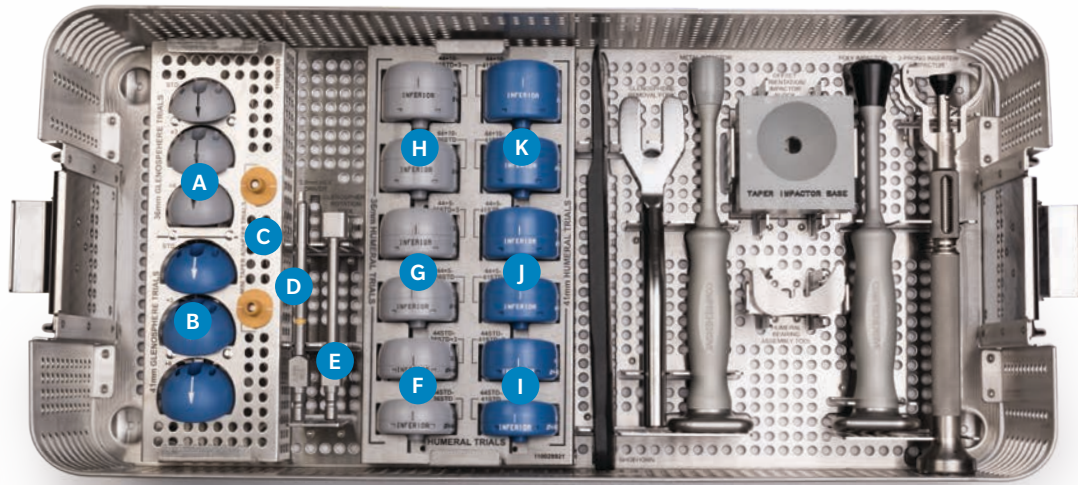

### 110028913 Comprehensive Reverse Glenoid Preparation Tray (Generation 2) (cont.)

Product	Description	Label	Size	Part Number
	Depth Gauge (Mini, Std, Peripheral)	K	—	110025762
	Hex Driver	L	3.5 mm Ø	110010424
	Ratchet Handle	M	—	405908
	Peripheral Screw Drill	N	2.7 mm Ø	405889
	Mini Baseplate Inferior/Superior Drill Guide	O	—	406207
	Inferior/Superior Drill Guide Bushing	P	—	405833
	Variable Angle Drill Guide	Q	—	405881
	Fixed Angle Drill Guide	R	—	405880









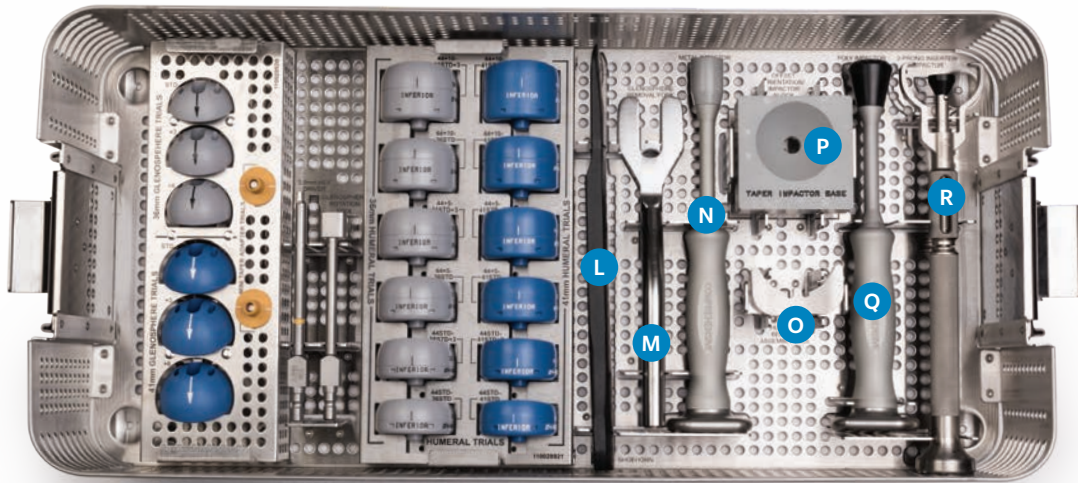

### 110028913 Comprehensive Reverse Glenoid Preparation Tray

Product	Description	Label	Size	Part Number
	36mm Glenosphere Provisionals	A	Standard +3 mm +6 mm	110029302 110029303 110029304
	41mm Glenosphere Provisionals	B	Standard +3 mm +6 mm	110029305 110029306 110029307
	Mini Baseplate Taper Adapter Trial (use with driver #110010424)	C	—	110028878
	Hex Driver	D	3.5 mm	110010424
	Glenosphere Provisional Rotation Tool	E	—	110028438
	36 mm Standard Humeral Tray/ Bearing Provisionals	F	Standard +3 mm	405940 405950
	36 mm +5 mm Humeral Tray/ Bearing Provisionals	G	Standard +3 mm	405945 405955
	36 mm +10 mm Humeral Tray/ Bearing Provisionals	H	Standard +3 mm	405948 405958
	41 mm Standard Humeral Tray/ Bearing Provisionals	I	Standard +3 mm	405970 405980
	41 mm +5 mm Humeral Tray/ Bearing Provisionals	J	Standard +3 mm	405975 405985
	41 mm +10 mm Humeral Tray/ Bearing Provisionals	K	Standard +3 mm	405978 405988







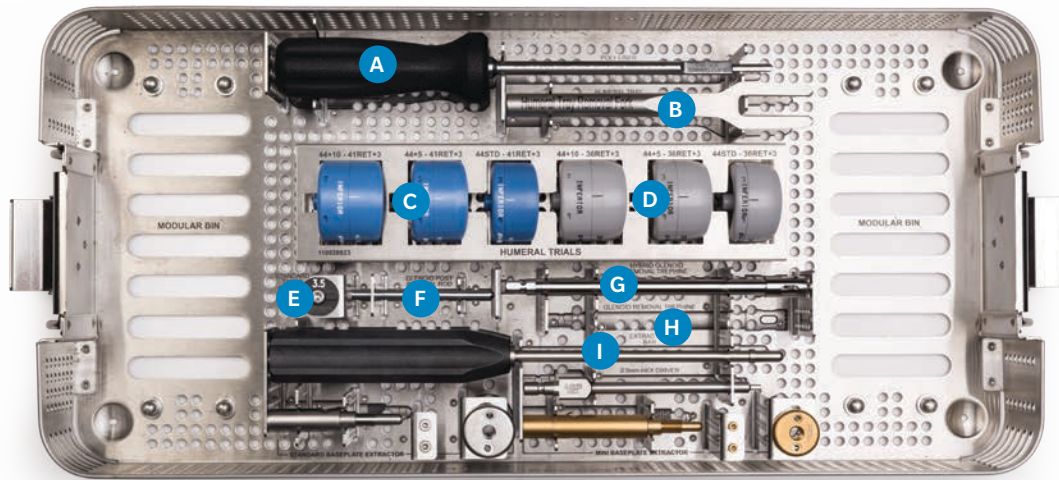



## 110028913 Comprehensive Reverse Glenoid Preparation Tray

Product	Description	Label	Part Number
	Shoehorn	L	405901
	Glenosphere Removal Fork	M	405832
	Metal Impactor	N	110029132
	Humeral Bearing Assembly Tool	O	110017268
	Offset Orientation Block / Taper Impaction Base	P	110027886
	Polyethylene Impactor	Q	110028055
	2-Prong Glenosphere Inserter/ Impactor	R	110028879
—	Replacement Glenosphere Trial Bin	—	110028920
—	Replacement Humeral Bearing Trial Bin	—	110028921



### 110028915 Comprehensive Reverse Revision Tray

Product	Description	Label	Size	Part Number
	Ringloc+ Liner Release Tool	A	—	31-424206
	Humeral Tray Removal Fork	B	—	406920
	36 mm +3 mm Retentive Humeral Tray/Bearing Provisionals	C	Standard +5 mm +10 mm	405960 405965 405968
	41 mm +3 mm Retentive Humeral Tray/Bearing Provisionals	D	Standard +5 mm +10 mm	405990 405995 405998
	Standard Baseplate Taper Adapter Trial (use with driver #110010424)	E	—	110028880
	Glenoid Removal Rod	F	2.5 mm	110003486
	Hybrid® Glenoid Removal Trephine	G	—	110003486
—	Future Expansion	H	—	—
	Baseplate Extractor Bar	I	—	406668



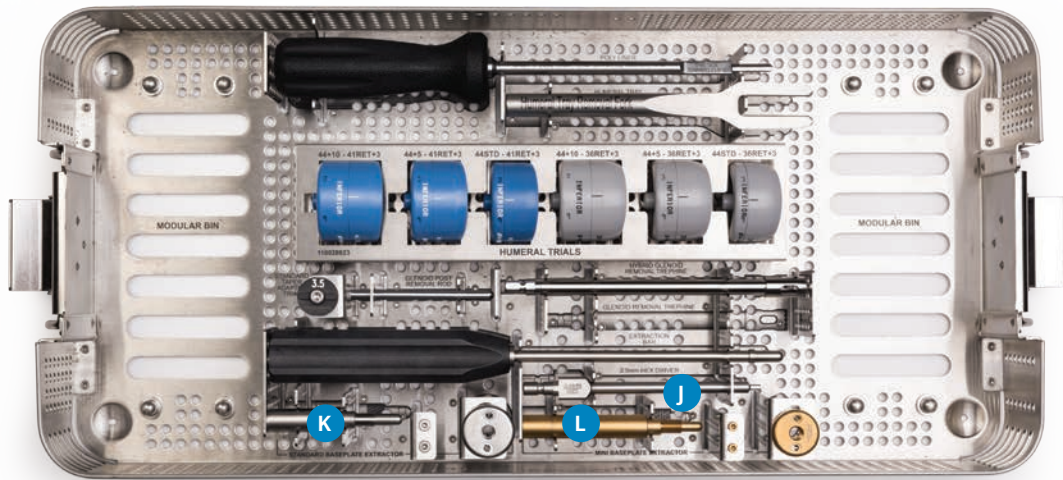





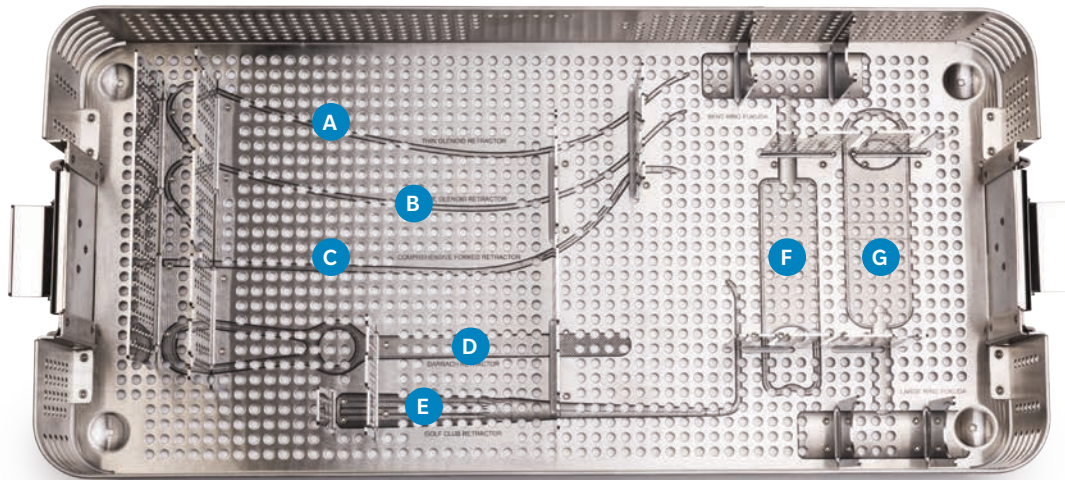

### 110028915 Comprehensive Reverse Revision Tray (cont.)

Product	Description	Label	Part Number
	Hex Driver	J	405885
	Standard Baseplate Extractor	K	405904
	Mini Baseplate Extractor	L	406209
—	Replacement Retentive Humeral Bearing Trial Bin	—	110028923







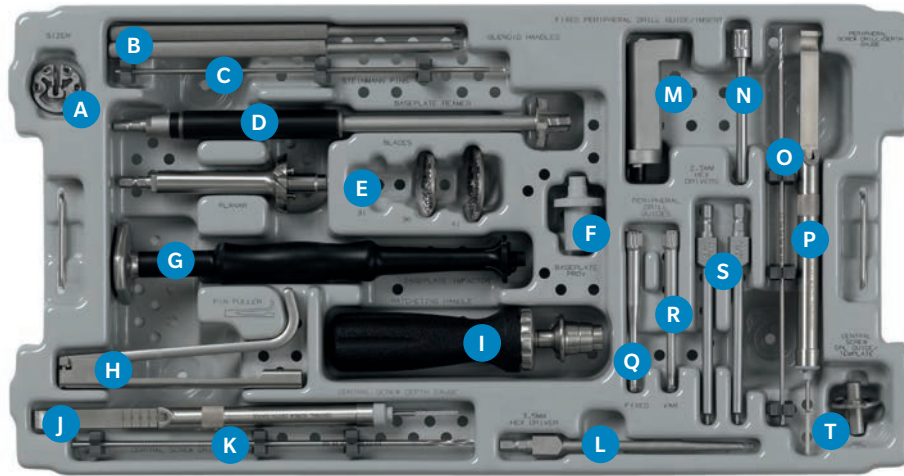

### 110028914 Comprehensive Reverse Retractor Tray







Product	Description	Label	Part Number
	Thin Glenoid Retractor	A	405892
	Wide Glenoid Retractor	B	405893
	2-Prong Forked Retractor	C	110028403
	Darrach Retractor	D	405895
	Golf Club Retractor	E	405891
	Bent Ring Fukuda Retractor	F	994500850
	Large Ring Fukuda Retractor	G	406699



### 595501 Comprehensive Reverse Glenoid Preparation Tray (Generation 1)





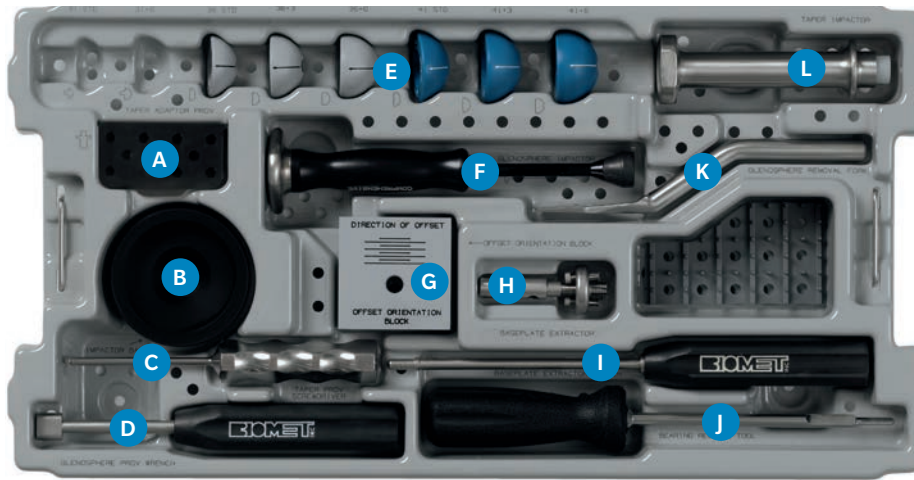

Product	Description	Label	Size	Part Number
	Sizer with 10 Degree Inferior Tilt	A	28 mm	405802
	Guide Handle	B	—	406849
	9 inch Steinmann Pin	C	3.2 mm Ø	405800
	Glenoid Baseplate Reamer	D	28 mm	405806
	Glenoid Planer with Blades	E	—	405890
	Baseplate Provisional	F	28 mm	405902
	Glenoid Baseplate Impactor	G	28 mm	405808
	Steinmann Pin Puller	H	—	32-420160

## 595501 Comprehensive Reverse Glenoid Preparation Tray (cont.)







Product	Description	Label	Size	Part Number
	Ratcheting Handle	I	—	405908
	Central Screw Depth Gauge Assembly	J	—	405831
	Central Screw Drill	K	3.2 mm Ø	405883
	3.5 Hex Central/Peripheral Screw Driver	L,S	3.5 mm	110010424
	Peripheral Drill and Screw Guide	M	28 mm	405882
	Peripheral Drill Guide Insert	N	2.7 mm	405833
	Peripheral Screw Drill	O	2.7 mm Ø	405889
	Peripheral Screw Depth Gauge Assembly	P	—	405830
	Fixed Angle Drill Guide	Q	—	405880
	Variable Angle Drill Guide	R	—	405881
	Peripheral Screw Hex Driver	S	2.5 mm	405885
	Drill Guide/Template (28 mm Baseplate)	T	3.2 mm Ø	405884



### 595502 Comprehensive Reverse Glenoid Trial Tray

Product	Description	Label	Size	Part Number
	Taper Adaptor Provisional	A	—	405906
	Versa-Dial Impactor Base	B	—	407281
	Versa-Dial Trial Screwdriver	C	—	407296
	Trial Glenosphere Wrench	D	—	405886
	Glenosphere Provisional Standard Glenosphere Provisional +3 mm Glenosphere Provisional +6 mm Glenosphere Provisional Standard Glenosphere Provisional +3 mm Glenosphere Provisional +6 mm	E	36 mm 36 mm 36 mm 41 mm 41 mm 41 mm	405810 405813 405816 405820 405823 405826
	Glenosphere Impactor	F	—	407297





## 595502 Comprehensive Reverse Glenoid Trial Tray (cont.)

Product	Description	Label	Size	Part Number
	Offset Orientation Block	G	—	405887
	Baseplate Extractor	H	28 mm	405904
	Baseplate Extraction Bar	I	—	406668
	RingLoc Liner Release Tool	J	—	31-424206
	Glenosphere Removal Fork	K	—	405832
	Versa-Dial Taper Impactor	L	—	407280









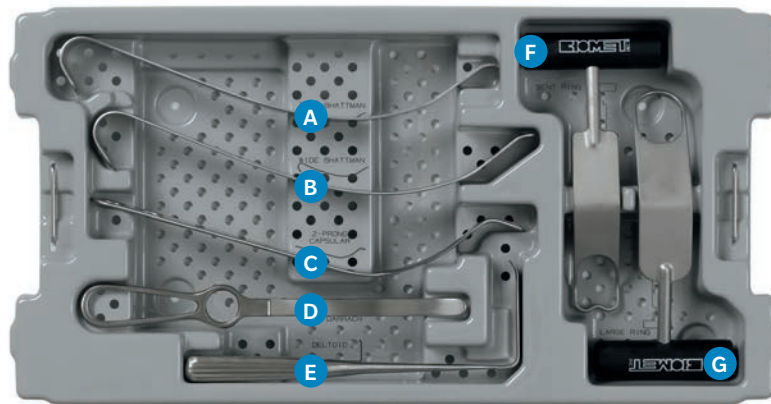

### 595503 Comprehensive Reverse Humeral Trial Tray

Product	Description	Label	Size	Part Number
	Shoehorn	A	—	405901
	Humeral Bearing/Tray Impactor	B	—	405835
	Humeral Bearing/Tray Trial, 44STD-36STD Humeral Bearing/Tray Trial, 44+5-36STD Humeral Bearing/Tray Trial, 44+10-36STD Humeral Bearing/Tray Trial, 44STD-36+3 Humeral Bearing/Tray Trial, 44+5-36+3 Humeral Bearing/Tray Trial, 44+10-36+3 Humeral Bearing/Tray Trial, 44STD-36RET+3 Humeral Bearing/Tray Trial, 44+5-36RET+3 Humeral Bearing/Tray Trial, 44+10-36RET+3	C	36 mm	405940 405945 405948 405950 405955 405958 405960 405965 405968
	Humeral Bearing/Tray Trial, 44STD-41STD Humeral Bearing/Tray Trial, 44+5-41STD Humeral Bearing/Tray Trial, 44+10-41STD Humeral Bearing/Tray Trial, 44STD-41+3 Humeral Bearing/Tray Trial, 44+5-41+3 Humeral Bearing/Tray Trial, 44+10-41+3 Humeral Bearing/Tray Trial, 44STD-41RET+3 Humeral Bearing/Tray Trial, 44+5-41RET+3 Humeral Bearing/Tray Trial, 44+10-41RET+3	D	41 mm	405970 405975 405978 405980 405985 405988 405990 405995 405998









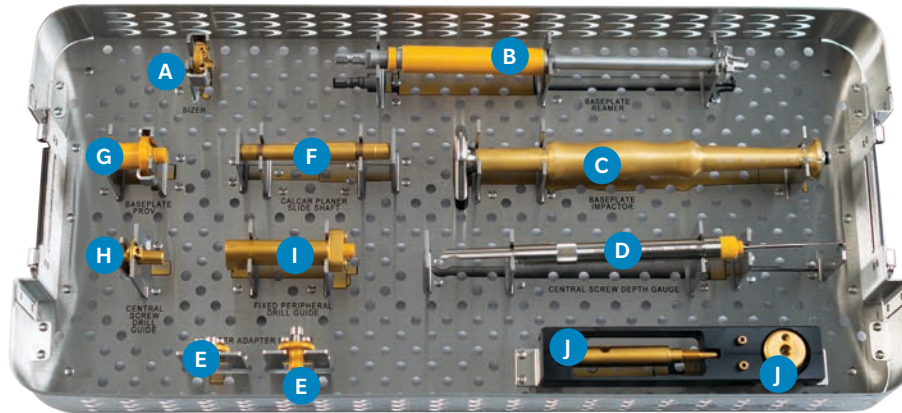



## 595505 Comprehensive Retractor Set Total Instrument Case

Product	Description	Label	Part Number
	Thin Glenoid Retractor	A	405892
	Wide Glenoid Retractor	B	405893
	2-Prong Capsular Retractor	C	110028403
	Modified Darrach Retractor	D	405895
	Golf Club Retractor	E	405891
	Bent Ring Fukuda	F	994500850
	Large Ring Fukuda	G	406699













## 593690 Comprehensive Reverse Mini Baseplate Tray

Product	Description	Label	Size	Part Number
	Comprehensive Mini Baseplate Sizer with 10 Degree Inferior Tilt	A	25 mm	405803
	Comprehensive Mini Glenoid Baseplate Reamer	B	25 mm	405807
	Comprehensive Mini Glenoid Baseplate Glenoid Baseplate Impactor	C	25 mm	405809
	Comprehensive Mini Baseplate Central Screw Depth Gauge Assembly	D	—	405829
	Comprehensive Mini Baseplate Taper Adaptor Provisional (use with driver #407296)	E	25 mm	405907
	Comprehensive Mini Baseplate Calcar Planar Slide Shaft	F	—	405909
	Comprehensive Mini Baseplate Provisional	G	25 mm	406205
	Comprehensive Mini Baseplate Drill Guide Template	H	3.2 mm Ø	406206
	Comprehensive Mini Baseplate Peripheral Drill and Screw Guide	I	25 mm	406207
	Comprehensive Mini Baseplate Extractor	J	25 mm	406209

## Optional Instruments May Not Be Included In All Sets

Product	Description	Size	Part Number
	Captured Sizer with 10 degree Inferior Tilt	28 mm	406202
	2-Prong Glenosphere Inserter/Impactor*	—	405900
	Glenosphere Forcep*	—	406236
	Glenosphere Trial Inserter	—	402640
	Humeral Tray (with slots) Removal Fork	—	406920
	Humeral Head Removal Fork	—	407389
	Humeral Bearing Assembly Tool	—	110017268
	Screw Caddy	—	180578
	<b>Comprehensive Reverse Templates</b>	—	<b>TMP-405801</b>

\*Not compatible with TM Reverse Glenospheres



This material is intended for health care professionals. Distribution to any other recipient is prohibited. For indications, contraindications, warnings, precautions, potential adverse effects and patient counselling information, see the package insert or contact your local representative; visit [www.zimmerbiomet.com](http://www.zimmerbiomet.com) for additional product information. Zimmer Biomet does not practice medicine. This technique was developed in conjunction with health care professionals. This document is intended for surgeons and is not intended for laypersons. Animations and virtual reality are provided as a visual guide based on surgical techniques; a written copy of the surgical technique is available at [www.zimmerbiomet.com](http://www.zimmerbiomet.com) or from your local representative. Each surgeon should exercise his or her own independent judgment in the diagnosis and treatment of an individual patient, and this information does not purport to replace the comprehensive training surgeons have received. As with all surgical procedures, the technique used in each case will depend on the surgeon's medical judgment as the best treatment for each patient. Results will vary based on health, weight, activity and other variables. Not all patients are candidates for this product and/or procedure. Caution: Federal (USA) law restricts this device to sale by or on the order of a surgeon. Rx only.

©2018 Zimmer Biomet



**Authorized Representative**

Biomet UK Ltd.  
Waterton Industrial Estate  
Bridgend, South Wales  
CF31 3XA  
UK



**ZIMMER BIOMET**

Your progress. Our promise®

0173.1-GLBL-en-REV1018



**Legal Manufacturer**

Biomet Orthopedics  
P.O. Box 587  
56 E. Bell Drive  
Warsaw, Indiana 46581-0587  
USA

[www.zimmerbiomet.com](http://www.zimmerbiomet.com)

**CE 0086**

CE mark on a surgical technique is not valid unless there is a CE mark on the product label.