



AFFIXUS

HIP FRACTURE NAIL

Surgical Technique

One Surgeon. One Patient.

Over 1 million times per year, Biomet helps one surgeon provide personalized care to one patient.

The science and art of medical care is to provide the right solution for each individual patient. This requires clinical mastery, a human connection between the surgeon and the patient, and the right tools for each situation.

At Biomet, we strive to view our work through the eyes of one surgeon and one patient. We treat every solution we provide as if it's meant for a family member.

Our approach to innovation creates real solutions that assist each surgeon in the delivery of durable personalized care to each patient, whether that solution requires a minimally invasive surgical technique, advanced biomaterials or a patient-matched implant.

When one surgeon connects with one patient to provide personalized care, the promise of medicine is fulfilled.

AFFIXUS Hip Fracture Nail

Contents

Features and Benefits	3
Indications and Pre-op Planning.....	7
Patient Positioning and Reduction.....	8
Entry and Canal Preparation	9
Nail Insertion.....	12
Proximal Locking	15
Distal Locking	23
End Cap Placement	25
Implant Removal	26
Implant Diagrams.....	27
Product Ordering Information	28



AFFIXUS Hip Fracture Nail



Strength and Stability in the Proximal Femur

- Optimal lag screw design for resistance to cut-out
- Easy-to-use instrumentation and targeting jig, which includes Goal Post technology, aids in lag screw placement
- Extensive range of neck/shaft angles, distal diameters, and nail lengths – combined with a small proximal nail diameter – allows the surgeon to achieve a close match for each patient's anatomy
- Unique distal bend facilitates entry through the proximal 1/3 of the femur and reduces potential for anterior cortex penetration

AFFIXUS Hip Fracture Nail

A system of **choices** for effective treatment of proximal femoral fractures

- Short (180 mm) and long (260 - 460 mm) nail options treat a wide range of proximal fracture indications using a single set of user-friendly instruments
- 15.6 mm proximal nail diameter
- Proximal 4° lateral bend allows for greater trochanteric entry site
- 125° and 130° neck angles provide a range of anatomical options
- 10° of proximal anteversion built into the nails
- 10.5 mm diameter cannulated lag screw for bone preservation
- Unique thread spacing and design of the lag screw helps to resist displacement and cut-out
- Chamfer on the front distal tip helps facilitate insertion and minimizes risk of stress on the anterior cortex in the distal femur
- 3° distal bend facilitates ease of insertion through the proximal intertrochanteric/subtrochanteric region
- Pre-loaded set screw for ease of use
- 5.0 mm anti-rotation (AR) screw for rotational control (optional)
- Shouldered lag screw and AR screw help prevent medial screw disengagement
- Long nail maintains a 1.8 M radius of curvature to closely match the femoral anatomy
- 5.0 mm diameter distal interlocking screws have a large core diameter for strong fixation
- Static or dynamic distal locking options with a 6 mm dynamization range





Multiple locking options for optimal implant stability



The AFFIXUS Hip Fracture Nail System, comprised of short and long nails, provides surgeons with an intramedullary hip screw to stabilize fractures of the proximal femur. The AFFIXUS Hip Fracture Nail combines the principles of a compression hip screw with the biomechanical advantages of an intramedullary nail.



Figure 1

AFFIXUS Hip Fracture Nail

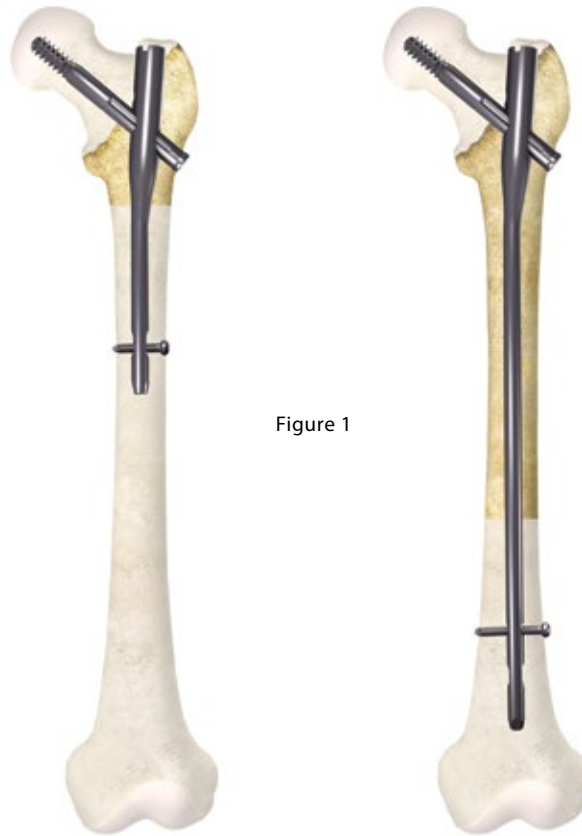

Figure 1

AFFIXUS Hip Fracture Nail
Short – (180 mm)

AFFIXUS Hip Fracture Nail
Long – (260 - 460 mm)

Indications and Pre-op Planning

The AFFIXUS Hip Fracture Nail System* is designed for antegrade trochanteric insertion to treat the following fractures (Figure 1):

The AFFIXUS Hip Fracture Nail System is intended to treat stable and unstable proximal fractures of the femur including pertrochanteric fractures, intertrochanteric fractures, high subtrochanteric fractures and combinations of these fractures, including non-union, malunion and tumor resections. The Long Nail system is additionally indicated to treat pertrochanteric fractures associated with shaft fractures, pathologic fractures in osteoporotic bone (including prophylactic use) of the trochanteric and diaphyseal areas, impending pathological fractures, long subtrochanteric fractures, ipsilateral femoral fractures, proximal or distal non-unions, malunions, revision procedures and tumor resections.

Note: Bone screws referenced in this material are not intended for screw attachment or fixation to the posterior elements (pedicles) of the cervical thoracic or lumbar spine.

* System includes short (180 mm) and long (260-460 mm) nails, in 20 mm increments.

AFFIXUS Hip Fracture Nail

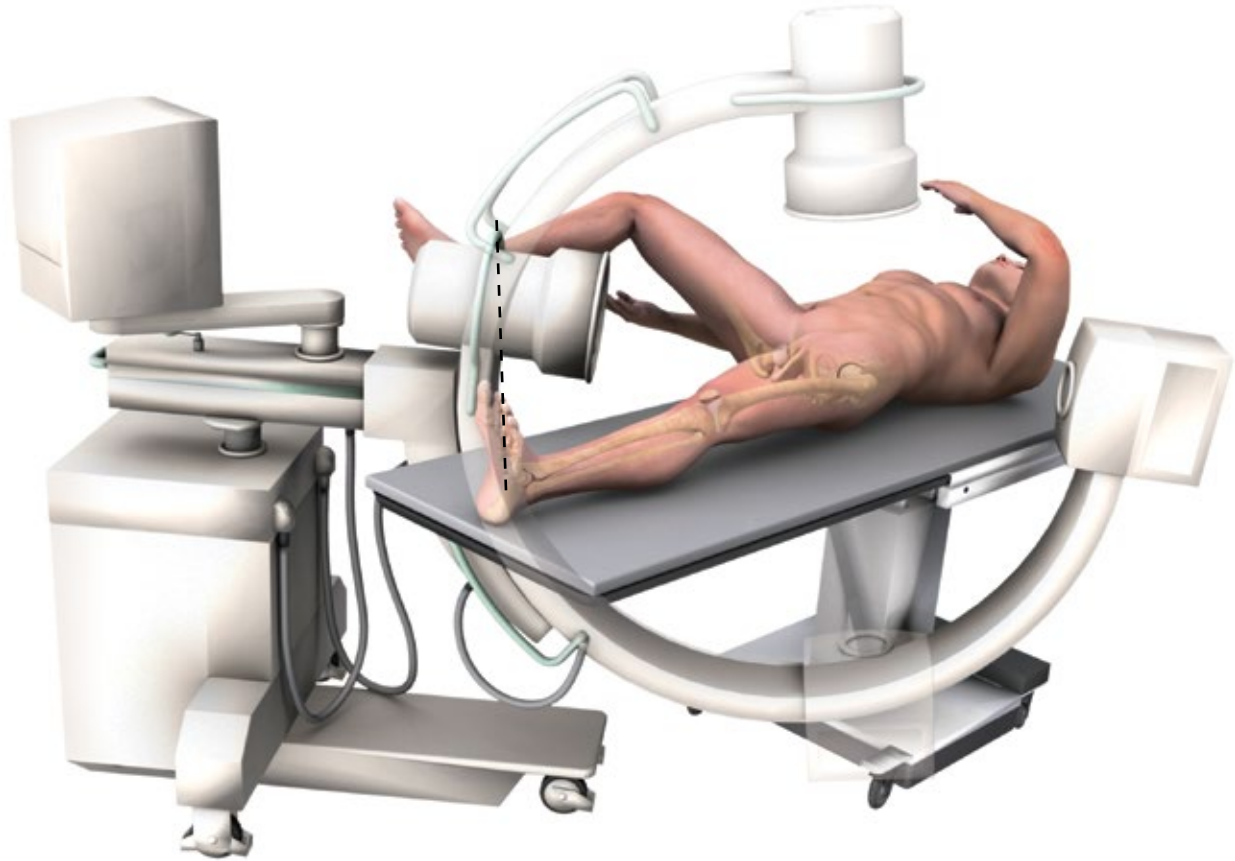

Figure 2

Patient Positioning and Reduction

Place the patient in the supine or lateral position on a fracture table or radiolucent imaging table. Lateral access to the proximal femur is required. Intraoperative image intensification with a C-arm is required to obtain AP and lateral imaging of the operative area during preoperative preparation (reduction) and throughout the procedure for nail insertion, nail locking, and anteversion alignment. Avoid excessive abduction of the hip during reduction as the access to the starting point and nail insertion may be impeded. The trunk may be laterally flexed away from the operative side to improve access to the starting point. The contralateral leg may be flexed at the hip or scissored below the affected leg in the supine position (Figure 2).

Closed Fracture Reduction

Fluoroscopy must be used to verify proper fracture reduction.

- Acceptable fracture alignment must be obtained prior to implant insertion
- Surgeon must avoid varus malreductions
- Use a combination of traction, rotation, adduction, and flexion/extension of the leg to obtain an acceptable reduction
- Open reductions may be required for more complicated fracture patterns and should be used when an acceptable closed reduction cannot be obtained (see page 10)

Initial Incision

Make an incision proximal to the tip of the greater trochanter in line with the femoral axis. Divide the fascia lata in line with its fibers and access the tip of the greater trochanter.

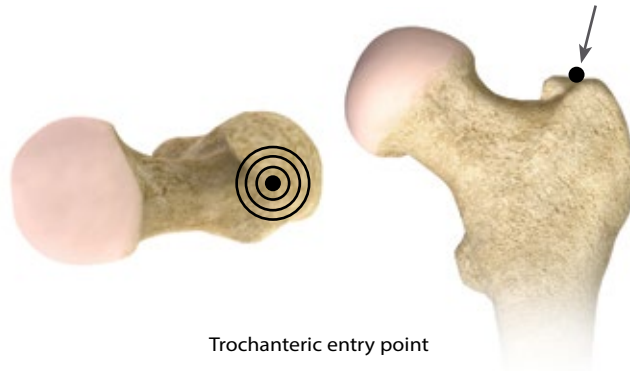

Trochanteric entry point

Figure 3

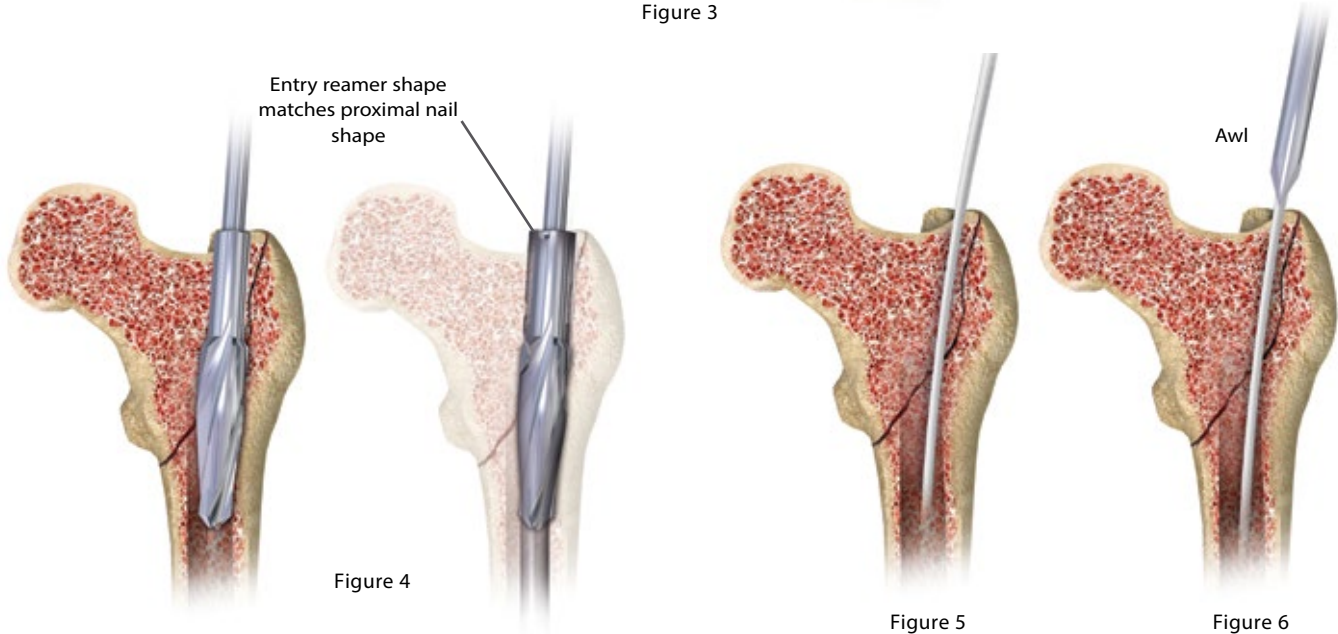

Figure 4

Figure 5

Figure 6

Entry and Canal Preparation

Femoral Entry Preparation

Attach the standard 3.2 mm guide pin to the pistol guidewire gripper or power source and pass it through the tip of the greater trochanter into the center of the femoral canal. Position the entry on the tip of the greater trochanter (Figure 3). Confirm on AP and lateral fluoroscopy views that the entry pin is centered on the trochanter.

Option 1: Cannulated Entry Reamer (One-step 16.6 mm)

Attach the cannulated entry reamer to the power source and pass it over the guide pin through the entry portal (Figure 4).

It is essential to ream until the reamer's proximal shaft passes with the greater trochanter's cortical bone as the shape of the entry reamer matches the nail shape and the top of the cylindrical segment of the reamer corresponds to the top of the nail (Figure 4). Reaming should continue until the tip of the entry reamer is at the level of the lesser trochanter and not beyond.

Option 2: Cannulated Awl

Pass the cannulated awl over the guide pin and introduce with a rotation motion until the awl is buried to at least half its blade length (Figure 5 & 6).

AFFIXUS Hip Fracture Nail



Figure 7



Figure 8

Open Fracture Reduction

Once access to the femoral canal has been gained, place the ball nose guide wire into the entry site utilizing the pistol guide wire gripper (Figure 7).

Obtain appropriate anatomic reduction in order to restore length, anatomic axis alignment, and rotation of the injured limb. Reduction can be achieved through the surgeon's preferred method such as traction, external fixator, external aids, or joysticks. To aid in manipulating the fracture fragments and passing the ball nose guide wire, long (7.5 mm diameter) and short (6.5 mm diameter) reduction tools are available.

Insert the reduction tool into the medullary canal, past the fracture site. Once the fracture is in alignment, pass the ball nose guide wire, available in both 80 cm and 100 cm lengths, across the fracture site. Remove the reduction tool (Figure 8).

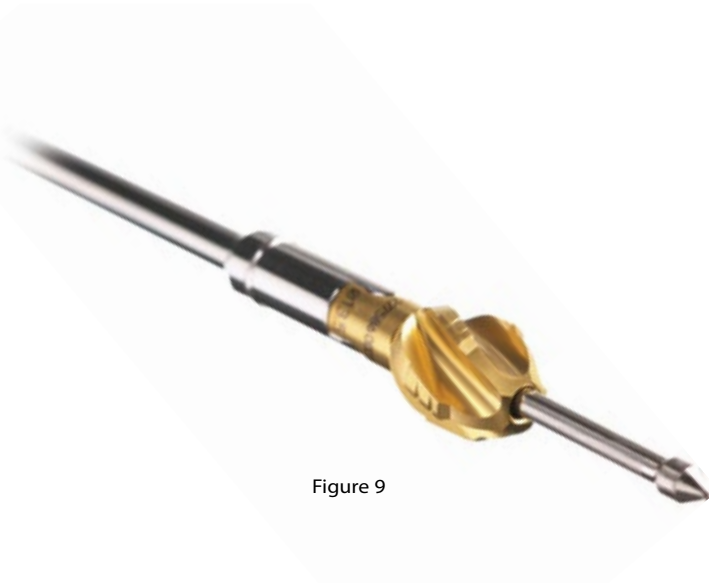

Figure 9



Figure 10

Canal Preparation

Short Nail

Confirm that the femoral diaphysis is wide enough and long enough to allow the selected nail diameter to pass. Ream as necessary to enlarge the diaphysis to accept the selected nail.

Long Nail

Achieve proper alignment of the injured limb prior to reaming. Maintain alignment throughout the reaming process to avoid eccentric reaming. Commence reaming by placing the flexible reamer over the ball nose guide wire (Figure 9).

Ream the medullary canal in millimeter increments until cortical bone is reached and in half-millimeter increments thereafter. Surgeon preference should dictate the actual extent of intramedullary reaming. Monitor the reaming procedure using image intensification to avoid eccentric or excessive cortical reaming.

Note: It is recommended to over-ream the diaphysis by 2 mm.

Nail Length Selection

With the tip of the ball nose guide wire at the level of the desired depth of nail insertion, slide or snap the nail depth gauge onto the ball nose guide wire until it contacts the bone, ensuring that the tip does not fall into the existing trochanteric entry canal, thus providing an inaccurate measurement. To obtain the appropriate nail length, read the measurement mark on the nail depth gauge that is closest to the beginning of the black transition area on the guide wire (Figure 10). If a nail of the exact measured length is not available, choose a shorter nail of the next closest available length. A direct measurement can also be taken of the uninjured extremity using either radiographs with magnification markers, or directly on the uninjured limb.

AFFIXUS Hip Fracture Nail

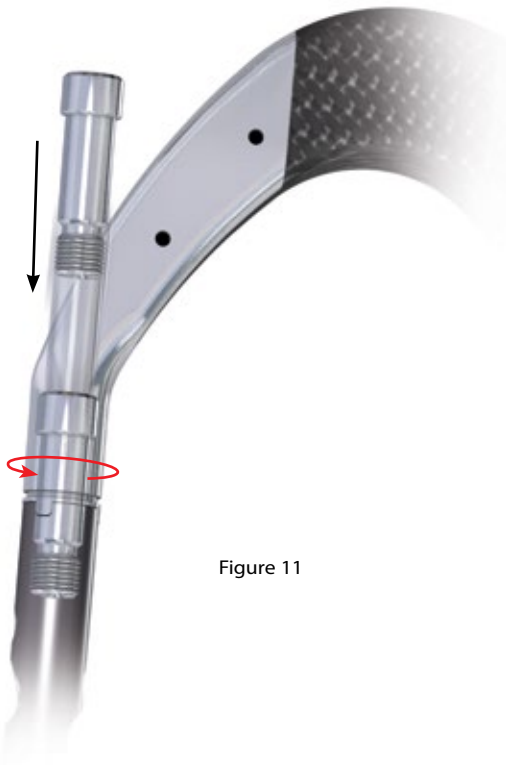

Figure 11



Figure 12

Nail Insertion

Jig Assembly

Select the appropriate targeting jig that corresponds to the neck shaft angle of the implant selected. Insert the jig bolt through the targeting jig using the jig bolt driver (Figure 11).

Note: 130° neck angle is most commonly used (Figure 12).



Figure 13A



Figure 13B

When assembling the nail to the insertion jig, ensure that the jig tabs align with the slots on the nail so that the nail fully seats in the targeting jig (Figure 13A). Once the nail is fully seated, securely tighten the jig bolt using the jig bolt driver

Note: If it is difficult to attach the nail to the jig, double-check that the nail and jig are identified with the same angle. The nail will only align with the jig if they have the same neck-shaft angle.

Check the assembly prior to nail introduction. Pass the lag screw sheath through the targeting jig. A properly assembled nail and jig will allow the lag screw drill to be directed through the sleeve and through the center of the lag screw hole in the nail.

When using a short (180 mm) nail, confirm the targeting alignment of the distal interlocking screws using the green sheaths and drill bits in the same manner (Figure 13B).

AFFIXUS Hip Fracture Nail



Figure 14

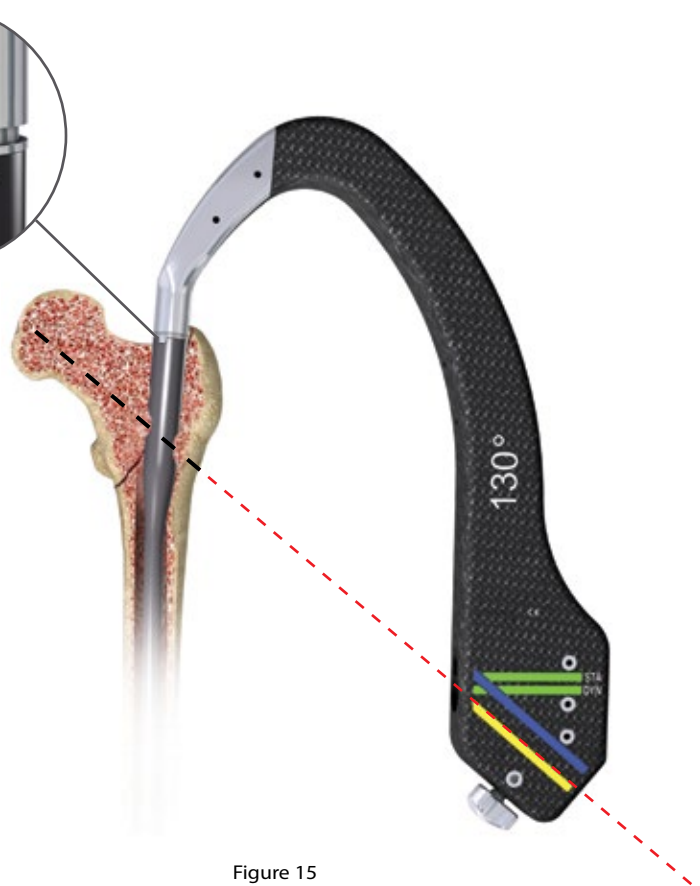

Figure 15

Nail Insertion

Insert the nail by hand over the 3 mm ball nose guide wire into the medullary canal. Take care not to strike the jig or targeting arm with the mallet. A curved impaction tool is included in the set and is meant to be used for gentle taps of the mallet to fine tune the final seating of the nail.

Note: The insertion jig should not be hammered on.

It may be helpful to preliminarily insert the trochanteric nail utilizing its bow to facilitate clearance of the medial femoral cortex of the proximal fragment. To do this, rotate the insertion jig anteriorly (toward the ceiling). In this position the distal bend in the nail will be angled laterally to aid in passing the nail through the greater trochanteric entry site, and avoid medial cortical penetration.

As the nail passes the medial cortex of the proximal fragment, slowly derotate the jig handle into the usual lateral position, so that the anterior bow of the nail now corresponds with the anterior bow of the femur (Figure 14). If the nail requires substantial force to advance, remove it and ream an additional millimeter. Avoid excessive force when inserting the nail. Advance the nail until the lag screw aligns to the desired position into the femoral head and neck to allow ideal placement of the lag screw (Figure 15).

Maintenance of reduction must be confirmed prior to lag screw insertion. If the reduction has shifted to a suboptimal position, further hip adduction, traction, and rotational adjustments can be made prior to lag screw placement. Remove the ball nose guide wire.

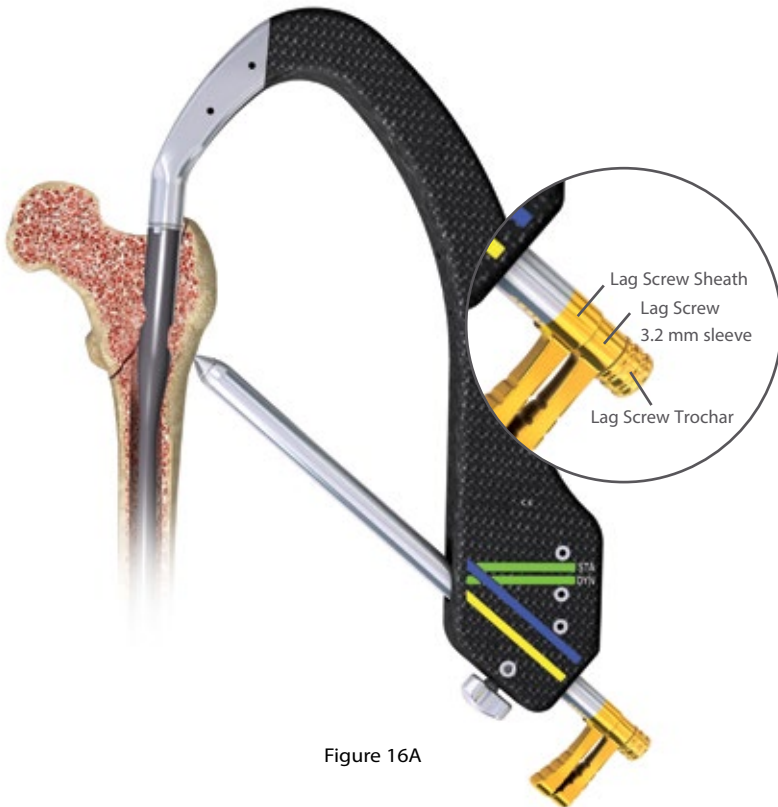

Figure 16A



Figure 16B

Proximal Locking

Lag Screw Guide Pin Introduction

Insert the lag screw sheath assembly (lag screw sheath, lag screw trochar, lag screw 3.2 mm sleeve) through the lag screw hole in the jig. Pass the trochar through the sheath and make an appropriate skin incision where the trochar contacts the skin. Advance the trochar through the tissue until the tip is seated against the lateral femoral cortex and confirm with fluoroscopy. The trochar may be impacted into the lateral cortex with a mallet to create a starting point for the guide pin and minimize migration during insertion (Figure 16A).

Remove the trochar and maintain the lag screw sheath position against the lateral femoral cortex.

Note: At the distal end of the jig assembly, the jig knob can be tightened to secure the position of the lag screw sheath to maintain contact against the lateral femoral cortex.

Introduce the 3.2 mm guide pin into the 3.2 mm sleeve and drill into position under fluoroscopic guidance. Check the guide pin position within the center of the femoral head and neck in both AP and lateral planes. Advance the guide pin to a distance within 5 mm from the subchondral bone (Figure 16B).

Note: If at any time a guide pin is bent, replace it immediately.

AFFIXUS Hip Fracture Nail

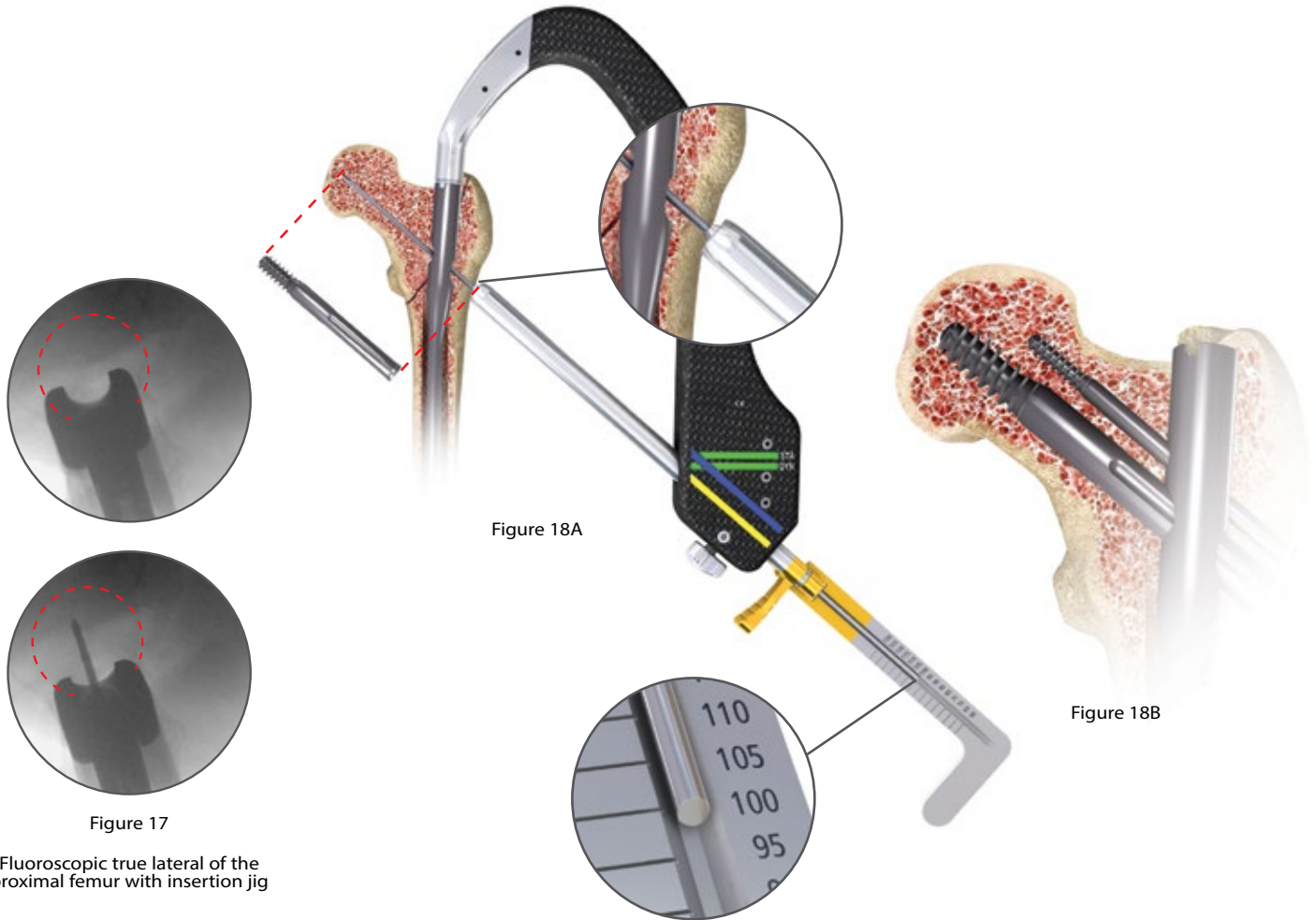

Figure 17

Fluoroscopic true lateral of the proximal femur with insertion jig

Figure 18A

Figure 18B

Goal Post Technology

The Goal Post Technology is designed to facilitate visualization of the femoral neck on the lateral view in order to more accurately place the guide pin for the lag screw. The anterior and posterior metal posts on the proximal aspect of the insertion jig allow for an unobstructed fluoroscopic view down to the base of the femoral neck (Figure 17) and assist with fine tuning of the guide pin before it is fully seated in the femoral head.

Lag Screw Length Selection

Before selecting a lag screw length, verify that the lag screw sheath and 3.2 mm sleeve are in place and fully seated against the lateral femoral cortex.

- The depth gauge seats against the lag screw sheath, not the 3.2 mm sleeve
- The system measures to the tip of the guide pin
- The measurement represents the length of a lag screw that begins at the end of the lag screw sheath and terminates at the tip of the guide pin (Figure 18A and 18B)

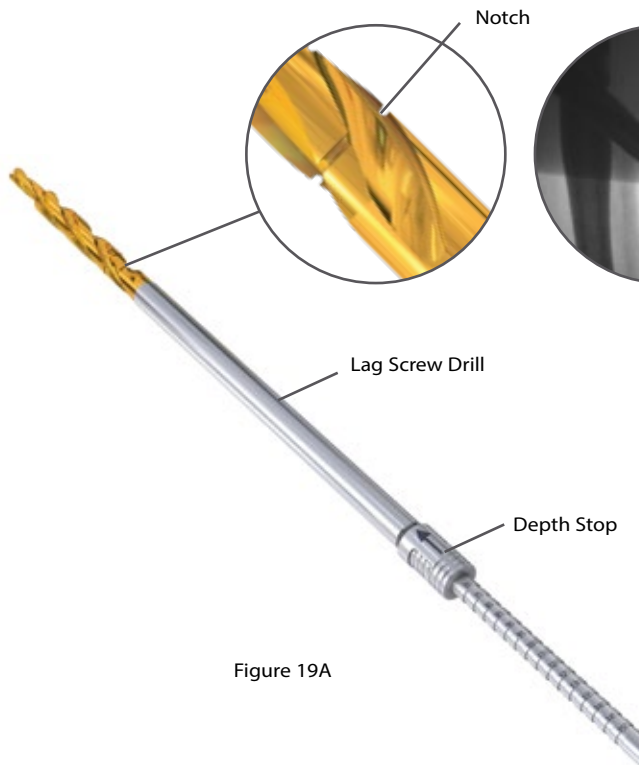

Figure 19A

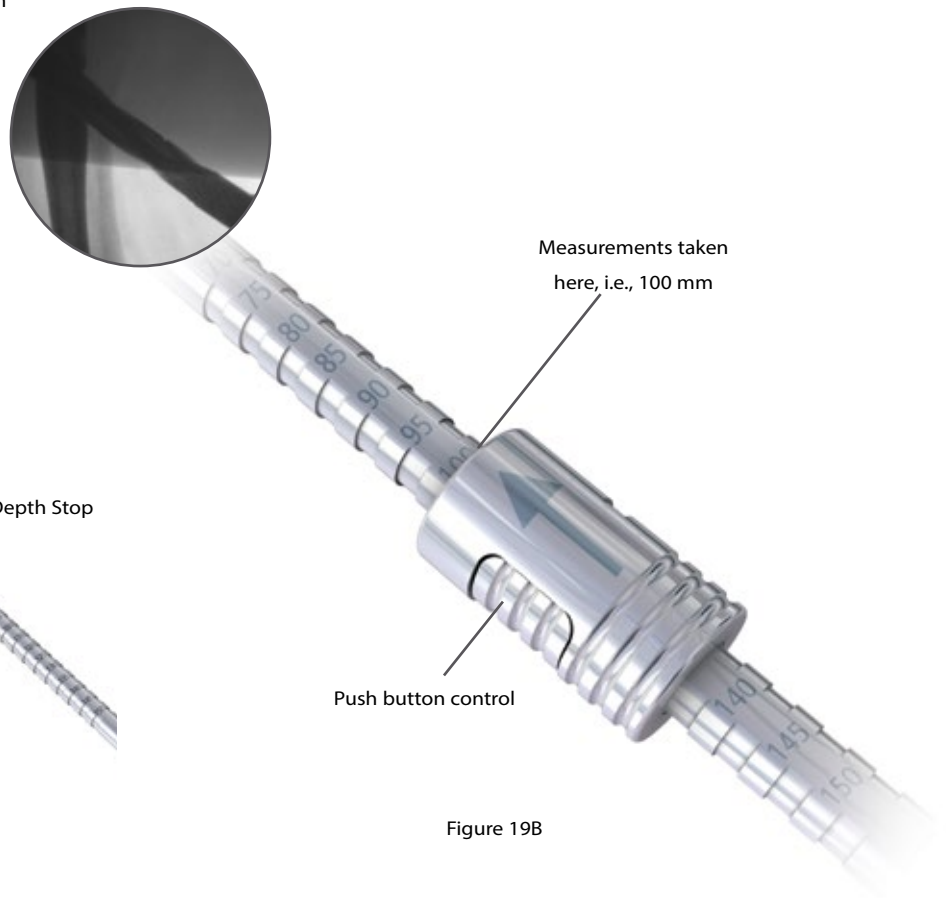

Figure 19B

Depth Stop Adjustment

Adjust the depth stop on the lag screw drill to the desired depth. The measurement on the depth stop should be set to the depth measured by the lag screw depth gauge (Figure 19A).

Adjust the depth stop by pushing in the button and sliding the stop forward or backward until desired depth is seen on the end of the depth stop closest to the gold drill bit tip (Figure 19B).

Note: There is a “notch” on the lag screw drill that is visible under fluoroscopy; this “notch” references 100 mm (Figure 19A).

Lag Screw Drilling and Tapping

Advance the lag screw drill over the guide pin and drill to the desired depth. Use fluoroscopy to confirm the position of the lag screw drill and that the guide pin is not advanced into the hip joint or acetabulum by the drill.

If the bone is particularly dense, use the cannulated tap to cut a thread for the lag screw.

Note: There is a guide pin repositioning tool to aid in reinserting the guide pin if it backs out with removal of the lag screw drill.

AFFIXUS Hip Fracture Nail

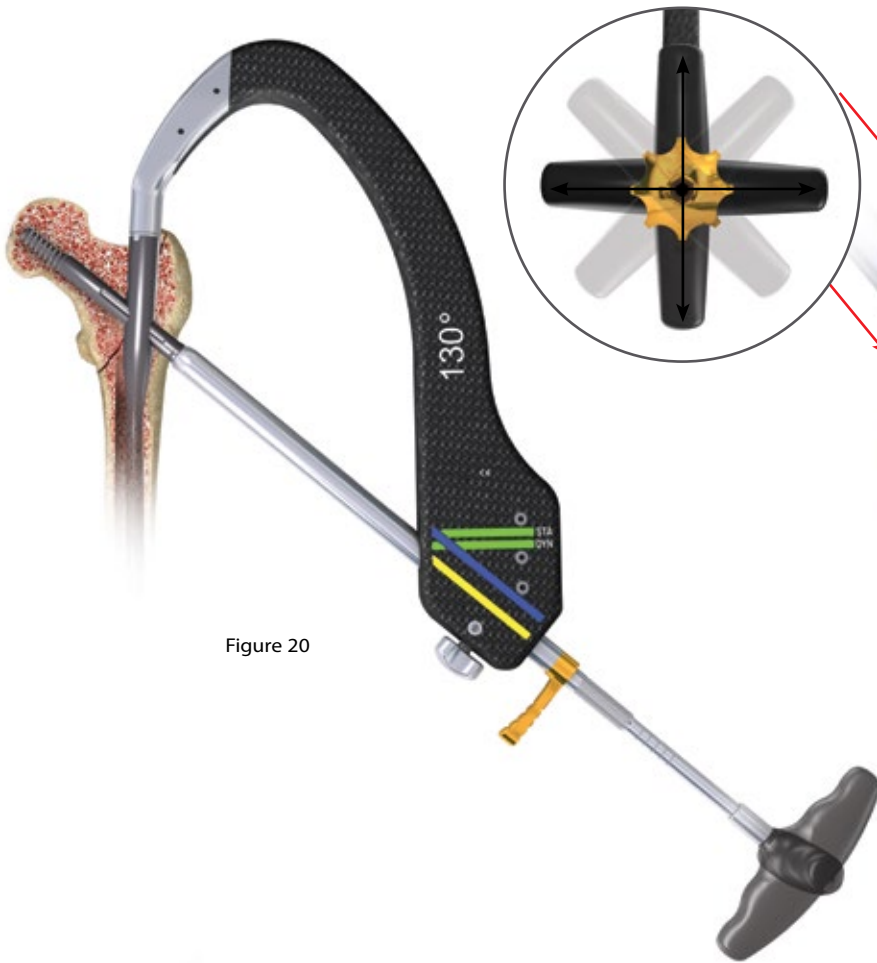

Figure 20



Figure 21

Lag Screw Insertion

Insert the lag screw coupling rod through the lag screw driver and position the selected lag screw on the end of the lag screw driver. Tighten the coupling rod to secure the lag screw to the driver.

Advance the lag screw manually into the femoral neck and head over the guide pin. Confirm the terminal position of the lag screw with fluoroscopy, with a goal of seating the screw between 5 and 10 mm from the subchondral bone.

The handle of the lag screw driver must be positioned either parallel or perpendicular to the targeting jig when the lag screw has been advanced to the desired depth (Figure 20). This will ensure that the set screw will engage one of the grooves of the lag screw.

Fracture Compression

Compression of the intertrochanteric component of the fracture, if desired, can be achieved by utilizing the compression wheel. Once the lag screw has been fully seated, release traction from the leg and firmly seat the lag screw sheath against the lateral cortex. Confirm that the sheath is tightly secured in the jig by tightening the jig knob, and place the compression wheel on the lag screw driver and advance against the lateral side of the sheath. In osteoporotic bone, care should be taken to avoid pulling the lag screw out of the femoral head with this technique (Figure 21).

Note: Hash marks on lag screw driver represent 5 mm intervals. It is recommended that no more than 4-6 mm of compression is applied and should be applied prior to placing the Anti-Rotation (AR) screw.



Figure 22A



Figure 22B

Cross section of set screw engaging lag screw

Lag Screw Fixation

The set screw is pre-loaded in the nail. Using the 5 mm set screw hex driver, engage the set screw and advance in a clockwise direction 2 to 3 full rotations until the set screw contacts the lag screw in one of the four lag screw grooves (Figure 22A & 22B).

To confirm proper position of the set screw, gently attempt to rotate the lag screw both clockwise and counterclockwise. If there is firm resistance and the lag screw will not rotate, the set screw has properly engaged the lag screw grooves. However, if you are able to rotate the lag screw, the set screw has not engaged a groove and the lag screw handle should be realigned and the set screw tightened again.

The set screw may be backed off one-quarter turn to allow dynamic compression of the lag screw in the nail, while still providing rotational control of the lag screw.

Note: The set screw can be engaged before or after inserting the AR screw (if the AR screw is to be used). The AR screw will align through an oblong hole within the set screw.

AFFIXUS Hip Fracture Nail

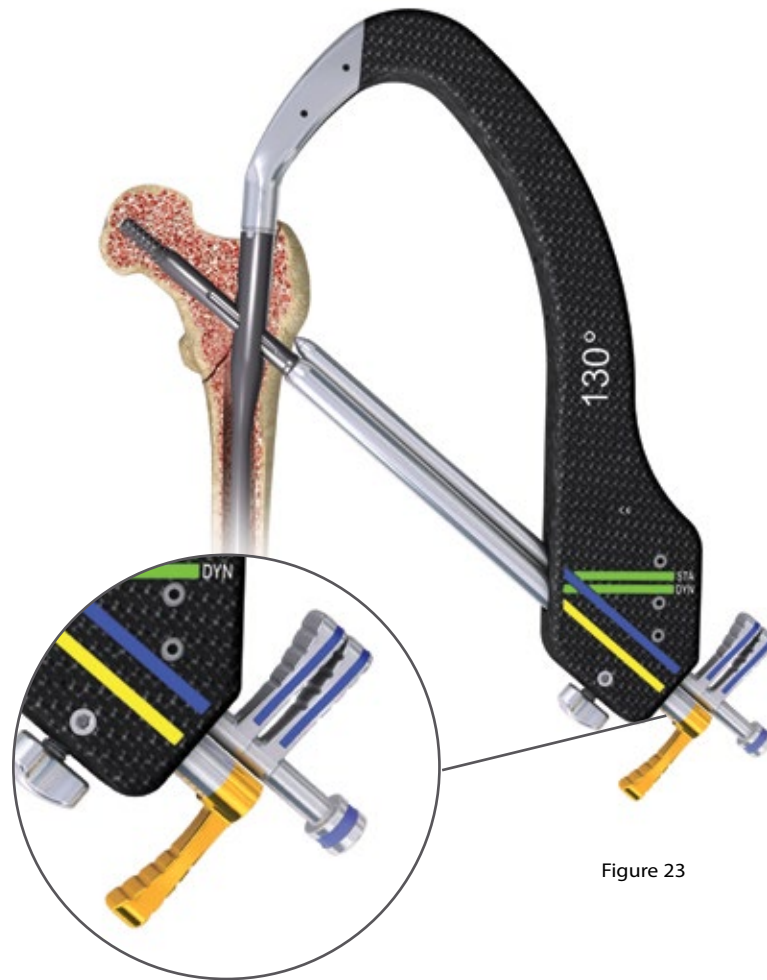

Figure 23

Anti-rotation (AR) Guide Pin and Screw Placement (optional)

This system allows multiple techniques for placement of an anti-rotation (AR) screw if desired.

- The AR screw may be inserted either before or after the lag screw is placed, based upon surgeon preference and the fracture pattern.
- The surgeon has the option to place a guide pin through the AR hole to provisionally stabilize the fracture during lag screw placement, or he/she may choose to use an AR screw. The guide pin used through the AR hole is also useful to assist in stabilizing the femoral neck and head segment during lag screw placement to resist rotation around the axis of the femoral neck. Once the lag screw has been placed and secured, the surgeon may choose to remove the guide pin from the AR hole and place a screw in this position to provide further rotational control.

Place the AR screw sheath and trochar through the AR hole in the insertion jig. Make a small incision where the trochar meets the skin and advance the trochar to the lateral aspect of the femoral cortex. Alternatively, in cases where the lag screw has already been inserted, extend the incision for the lag screw proximally to allow the AR screw sheath and trochar to be seated against the femur (Figure 23).

Note: When the anti-rotation and lag screw sheaths are seated at the same time, they must be rotated so the groove on the lag screw sheath faces the anti-rotation screw sheath (so the colored handles are 180 degree to each other) in order to allow both sheaths to fully seat (Figure 23).

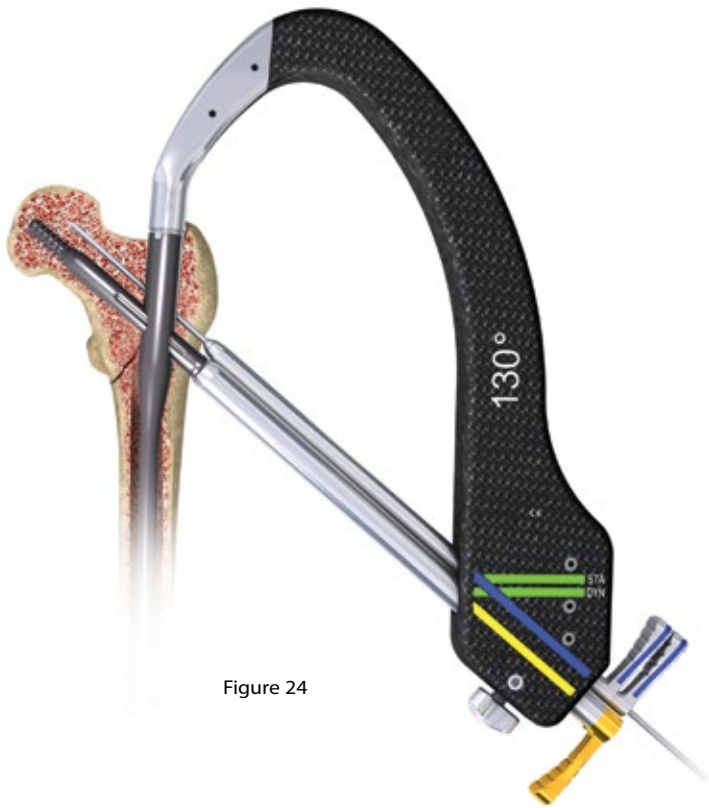

Figure 24

Remove the trochar and insert the AR 3.2 mm sleeve. Insert the 3.2 mm guide pin and advance into desired position. It is recommended to leave the AR guide pin 15-20 mm from the subchondral bone (Figure 24).

Note: In cases where very dense cortical bone is encountered, the cortex may be opened up with the anti-rotation screw drill prior to advancing the 3.2 mm guide pin to prevent the guide pin from “walking” up the lateral cortex.

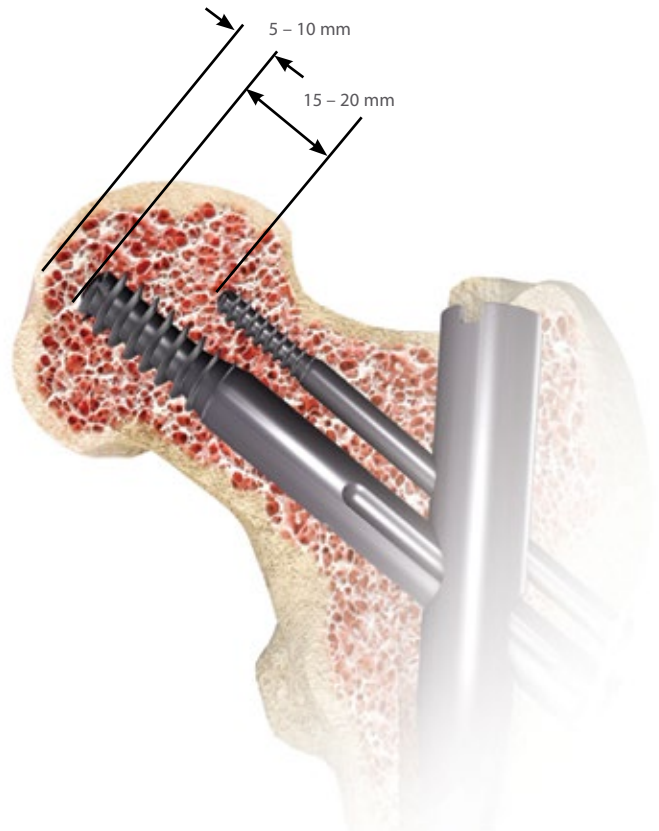

Figure 25

Remove the guide pin and 3.2 mm sleeve. Confirm that the screw sheath is advanced against the lateral femoral cortex and use the AR drill to drill to the desired depth. Measure the length of the desired screw by reading the depth of the AR drill against the screw sheath.

Note: It is recommended that the tip of the AR screw be 15-20 mm shorter than the lag screw to avoid perforation of the femoral head (Figure 25).

AFFIXUS Hip Fracture Nail



Figure 26

Select an AR screw of the desired length. Place the AR screw on the 3.5 mm hex driver and manually insert the screw into the femur through the AR screw sheath.

Advance until the tip of the screw reaches the desired depth and confirm with fluoroscopy. The screwdriver and sheath may now be removed.

Securing the AR Screw (optional)

The AR screw may be secured with an impinging end cap that is inserted through the end of the nail.

Note: The impinging end cap will make the AR screw a static construct and is recommended to only be used when the lag screw is also fixed in a static position (this can be achieved by not backing off the pre-loaded set

screw a quarter turn). Otherwise there is risk of creating the Z-effect.

It is recommended to only lock the AR screw in instances in which the set screw has been left fully engaged into the lag screw, thus preventing any collapse of the 10.5 mm compression screw (Figure 26).

The impinging end cap may be utilized at the end of the case, after the set screw for the lag screw has been tightened, and the insertion jig has been removed.



Figure 27



Figure 28

Distal Locking

Distal Locking (short nails)

The short nail may be locked either statically, dynamically, or left unlocked based on the particular fracture pattern and stability (Figure 27).

Pass the distal screw sheath and trochar through the hole labeled “static” on the insertion jig and advance to the lateral femoral cortex. Remove the trochar and use the distal screw drill sleeve and 4.3 mm graduated drill bit. Drill until the far cortex is either reached or penetrated. The drill is calibrated and may be used to determine screw length by reading the depth off the end of the distal screw drill sleeve (Figure 28).

An optional distal screw depth gauge is available to confirm screw length. This gauge measures off of the lateral side of the 4.3 mm distal screw drill sleeve.

Select a 5.0 mm diameter screw of the desired depth and use the 3.5 mm hex driver long to introduce the screw through the screw sheath and advance until it is fully seated against the lateral cortex.

Repeat the above steps for dynamic locking, except pass the distal screw sheath and trochar through the hole labeled “dynamic” on the insertion jig.

Note: Maintain contact of the drill sheath on the lateral femoral cortex to ensure accurate measurement of the distal locking screw. Verify screw position using AP and lateral fluoroscopy imaging.

Note: There are two 4.3 mm drill bits available. Use the long bit when drilling through the jig assembly and use the short bit when performing the freehand approach.

AFFIXUS Hip Fracture Nail

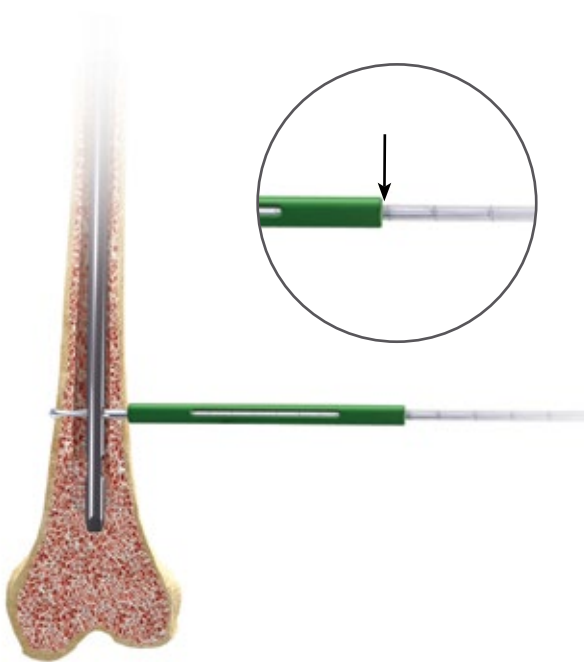

Figure 29

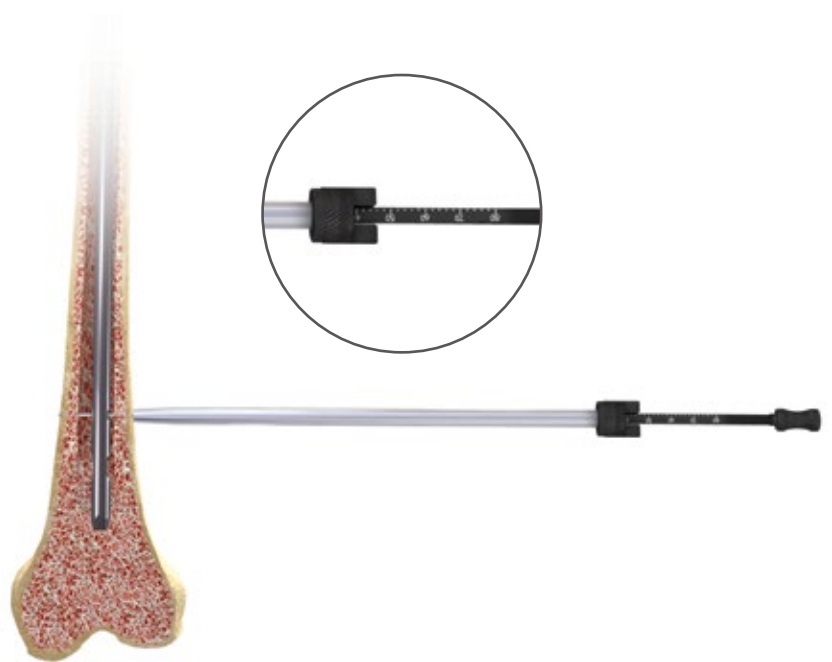

Figure 30

Distal Locking (long nails)

Prior to locking the distal screw(s), check femoral length and rotation under fluoroscopy. Distal locking of long nails should be conducted using the standard image intensification freehand technique.

Option 1

Using the short 4.3 mm graduated drill and the 4.3 mm drill measuring sleeve, drill until the far cortex is either reached or penetrated. Verify the drill bit position fluoroscopically prior to taking any measurements. Read the calibration directly off of the 4.3 mm graduated drill by using the drill measuring sleeve. The measurement should be taken from the end of the measuring sleeve, closest to the power source (Figure 29).

Option 2

Using the short 4.3 mm graduated drill, drill until the far cortex is either reached or penetrated. Remove the 4.3 mm graduated drill and measure using the distal screw depth gauge. Ensure that the sheath of the distal screw depth gauge is fully seated on the bone (Figure 30).

Remove the drill bit and advance the 5.0 mm screw using the solidlok screwdriver or 3.5 mm hex driver. Repeat the above steps for additional screw placement.



Figure 31

End Cap Placement

End Cap Placement (optional)

Unscrew the jig bolt that connects the insertion jig to the end of the nail using the jig bolt driver. Remove the insertion jig and use fluoroscopy to determine the length of the end cap desired, with a goal of leaving the proximal aspect of the end cap flush with the tip of the greater trochanter.

Attach the end cap to the 5 mm end cap hex driver and insert into the end of the nail. Tighten the end cap by turning clockwise until the end cap fully seats against the top of the nail. If fixation of the AR screw is desired, select the impinging in cap instead of the standard end cap (Figure 31).

AFFIXUS Hip Fracture Nail



Figure 32

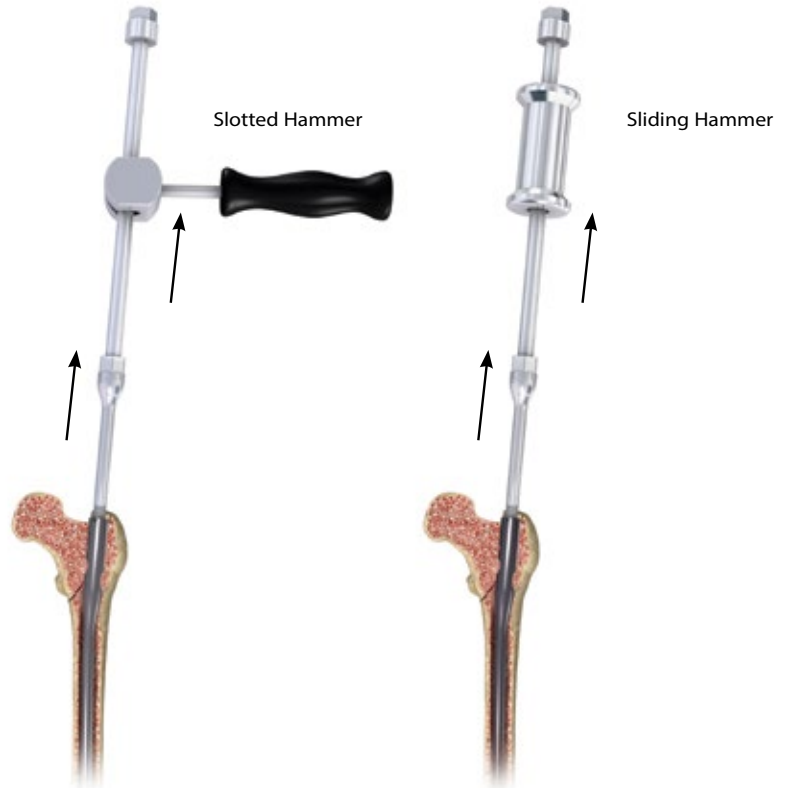

Figure 33

Implant Removal

Identify the proximal end of the nail by opening the same incision used for insertion of the implant. Clear bone from the proximal end of nail if necessary or remove the end cap (if present) with the 5 mm end cap hex driver.

- Remove the distal screw using the 3.5 mm hex driver after making an incision through the scar site.
- If an AR screw is present, use the AR screw removal tool to extract the AR screw prior to loosening the set screw.

Reminder: The set screw should NOT be loosened prior to removing the AR screw.

- Use the 5 mm set screw hex driver to loosen the set screw. This will allow the lag screw to rotate counterclockwise. Typically 2 to 3 full rotations is all that is necessary.
- Attach the lag screw driver and coupling rod to the lateral end of the lag screw and confirm that it will freely rotate in a counterclockwise direction.

- Insert the cannulated extraction bolt into the proximal end of the nail (Figure 32).

Note: If the extraction bolt is not threading into the proximal end of the nails, the set screw may have been backed out too far and should be advanced clockwise.

- Attach the extraction rod to the extraction bolt.
- Remove the lag screw by turning counterclockwise and then remove the distal interlocking screws.
- Use the sliding hammer or slotted mallet over the extraction rod and back slap to remove the nail (Figure 33).

Note: It is recommended that the extraction rod and bolt be attached to the nail prior to removing the final screw to prevent the nail from being forced down the intramedullary canal.

Note: The conical extractor is designed to cross thread onto the nail, and it is recommended that it is tightly secured to the nail before the lag screw is removed to prevent the nail from rotating in the femoral canal.

Implant Diagrams



Distal Screw, 20-80 mm
Sterile: 8145-50-0XX

- Diameter 5.0 mm
- 3.5 mm Hex Driver Socket



Anti-rotation Screw, 50-110 mm
Sterile: 8145-01-XXX

- Diameter 5.0 mm
- 3.6 mm Hex Driver Socket
- 3 mm Inner Thread for Removal
- Self Tapping Threads



Lag Screw, 70-130 mm
Sterile: 8145-10-XXX

- Diameter 10.5 mm
- Reverse Buttress Thread
- 6.5 mm Square Driver Socket
- Self Tapping Threads



AFFIXUS Hip Fracture Nail

Product Ordering Information

Rights **Lefts**

Long Nails, 9 mm, 125°

8143-09-260	8144-09-260	125° 9 mm X 260 mm
8143-09-280	8144-09-280	125° 9 mm X 280 mm
8143-09-300	8144-09-300	125° 9 mm X 300 mm
8143-09-320	8144-09-320	125° 9 mm X 320 mm
8143-09-340	8144-09-340	125° 9 mm X 340 mm
8143-09-360	8144-09-360	125° 9 mm X 360 mm
8143-09-380	8144-09-380	125° 9 mm X 380 mm
8143-09-400	8144-09-400	125° 9 mm X 400 mm
8143-09-420	8144-09-420	125° 9 mm X 420 mm
8143-09-440	8144-09-440	125° 9 mm X 440 mm
8143-09-460	8144-09-460	125° 9 mm X 460 mm

Long Nails, 11 mm, 125°

8143-11-260	8144-11-260	125° 11 mm X 260 mm
8143-11-280	8144-11-280	125° 11 mm X 280 mm
8143-11-300	8144-11-300	125° 11 mm X 300 mm
8143-11-320	8144-11-320	125° 11 mm X 320 mm
8143-11-340	8144-11-340	125° 11 mm X 340 mm
8143-11-360	8144-11-360	125° 11 mm X 360 mm
8143-11-380	8144-11-380	125° 11 mm X 380 mm
8143-11-400	8144-11-400	125° 11 mm X 400 mm
8143-11-420	8144-11-420	125° 11 mm X 420 mm
8143-11-440	8144-11-440	125° 11 mm X 440 mm
8143-11-460	8144-11-460	125° 11 mm X 460 mm

Long Nails, 13 mm, 125°

8143-13-260	8144-13-260	125° 13 mm X 260 mm
8143-13-280	8144-13-280	125° 13 mm X 280 mm
8143-13-300	8144-13-300	125° 13 mm X 300 mm
8143-13-320	8144-13-320	125° 13 mm X 320 mm
8143-13-340	8144-13-340	125° 13 mm X 340 mm
8143-13-360	8144-13-360	125° 13 mm X 360 mm
8143-13-380	8144-13-380	125° 13 mm X 380 mm
8143-13-400	8144-13-400	125° 13 mm X 400 mm
8143-13-420	8144-13-420	125° 13 mm X 420 mm
8143-13-440	8144-13-440	125° 13 mm X 440 mm
8143-13-460	8144-13-460	125° 13 mm X 460 mm

Rights **Lefts**

Long Nails, 9 mm, 130°

8145-09-260	8146-09-260	130° 9 mm X 260 mm
8145-09-280	8146-09-280	130° 9 mm X 280 mm
8145-09-300	8146-09-300	130° 9 mm X 300 mm
8145-09-320	8146-09-320	130° 9 mm X 320 mm
8145-09-340	8146-09-340	130° 9 mm X 340 mm
8145-09-360	8146-09-360	130° 9 mm X 360 mm
8145-09-380	8146-09-380	130° 9 mm X 380 mm
8145-09-400	8146-09-400	130° 9 mm X 400 mm
8145-09-420	8146-09-420	130° 9 mm X 420 mm
8145-09-440	8146-09-440	130° 9 mm X 440 mm
8145-09-460	8146-09-460	130° 9 mm X 460 mm

Long Nails, 11 mm, 130°

8145-11-260	8146-11-260	130° 11 mm X 260 mm
8145-11-280	8146-11-280	130° 11 mm X 280 mm
8145-11-300	8146-11-300	130° 11 mm X 300 mm
8145-11-320	8146-11-320	130° 11 mm X 320 mm
8145-11-340	8146-11-340	130° 11 mm X 340 mm
8145-11-360	8146-11-360	130° 11 mm X 360 mm
8145-11-380	8146-11-380	130° 11 mm X 380 mm
8145-11-400	8146-11-400	130° 11 mm X 400 mm
8145-11-420	8146-11-420	130° 11 mm X 420 mm
8145-11-440	8146-11-440	130° 11 mm X 440 mm
8145-11-460	8146-11-460	130° 11 mm X 460 mm

Long Nails, 13 mm, 130°

8145-13-260	8146-13-260	130° 13 mm X 260 mm
8145-13-280	8146-13-280	130° 13 mm X 280 mm
8145-13-300	8146-13-300	130° 13 mm X 300 mm
8145-13-320	8146-13-320	130° 13 mm X 320 mm
8145-13-340	8146-13-340	130° 13 mm X 340 mm
8145-13-360	8146-13-360	130° 13 mm X 360 mm
8145-13-380	8146-13-380	130° 13 mm X 380 mm
8145-13-400	8146-13-400	130° 13 mm X 400 mm
8145-13-420	8146-13-420	130° 13 mm X 420 mm
8145-13-440	8146-13-440	130° 13 mm X 440 mm
8145-13-460	8146-13-460	130° 13 mm X 460 mm

Long Nails, 15 mm, 130°

8145-15-320	8146-15-320	130° 15 mm X 320 mm
8145-15-360	8146-15-360	130° 15 mm X 360 mm
8145-15-400	8146-15-400	130° 15 mm X 400 mm
8145-15-440	8146-15-440	130° 15 mm X 440 mm

Short Nails, 125°

8143-09-180	125° 9 mm X 180 mm
8143-11-180	125° 11 mm X 180 mm
8143-13-180	125° 13 mm X 180 mm

Short Nails, 130°

8145-09-180	130° 9 mm X 180 mm
8145-11-180	130° 11 mm X 180 mm
8145-13-180	130° 13 mm X 180 mm

Lag Screws

8145-10-070	LAG SCREW 10.5 mm X 70 mm
8145-10-075	LAG SCREW 10.5 mm X 75 mm
8145-10-080	LAG SCREW 10.5 mm X 80 mm
8145-10-085	LAG SCREW 10.5 mm X 85 mm
8145-10-090	LAG SCREW 10.5 mm X 90 mm
8145-10-095	LAG SCREW 10.5 mm X 95 mm
8145-10-100	LAG SCREW 10.5 mm X 100 mm
8145-10-105	LAG SCREW 10.5 mm X 105 mm
8145-10-110	LAG SCREW 10.5 mm X 110 mm
8145-10-115	LAG SCREW 10.5 mm X 115 mm
8145-10-120	LAG SCREW 10.5 mm X 120 mm
8145-10-125	LAG SCREW 10.5 mm X 125 mm
8145-10-130	LAG SCREW 10.5 mm X 130 mm

Anti-Rotation Screws

8145-01-050	A/R SCREW 50 mm
8145-01-055	A/R SCREW 55 mm
8145-01-060	A/R SCREW 60 mm
8145-01-065	A/R SCREW 65 mm
8145-01-070	A/R SCREW 70 mm
8145-01-075	A/R SCREW 75 mm
8145-01-080	A/R SCREW 80 mm
8145-01-085	A/R SCREW 85 mm
8145-01-090	A/R SCREW 90 mm
8145-01-095	A/R SCREW 95 mm
8145-01-100	A/R SCREW 100 mm
8145-01-105	A/R SCREW 105 mm
8145-01-110	A/R SCREW 110 mm

Distal Screws

8145-50-020	CORTICAL BONE SCR 5.0 mm X 20 mm
8145-50-022	CORTICAL BONE SCR 5.0 mm X 22 mm
8145-50-024	CORTICAL BONE SCR 5.0 mm X 24 mm
8145-50-026	CORTICAL BONE SCR 5.0 mm X 26 mm
8145-50-028	CORTICAL BONE SCR 5.0 mm X 28 mm
8145-50-030	CORTICAL BONE SCR 5.0 mm X 30 mm
8145-50-032	CORTICAL BONE SCR 5.0 mm X 32 mm
8145-50-034	CORTICAL BONE SCR 5.0 mm X 34 mm
8145-50-036	CORTICAL BONE SCR 5.0 mm X 36 mm
8145-50-038	CORTICAL BONE SCR 5.0 mm X 38 mm
8145-50-040	CORTICAL BONE SCR 5.0 mm X 40 mm
8145-50-042	CORTICAL BONE SCR 5.0 mm X 42 mm
8145-50-044	CORTICAL BONE SCR 5.0 mm X 44 mm
8145-50-046	CORTICAL BONE SCR 5.0 mm X 46 mm
8145-50-048	CORTICAL BONE SCR 5.0 mm X 48 mm
8145-50-050	CORTICAL BONE SCR 5.0 mm X 50 mm
8145-50-052	CORTICAL BONE SCR 5.0 mm X 52 mm
8145-50-054	CORTICAL BONE SCR 5.0 mm X 54 mm
8145-50-056	CORTICAL BONE SCR 5.0 mm X 56 mm
8145-50-058	CORTICAL BONE SCR 5.0 mm X 58 mm
8145-50-060	CORTICAL BONE SCR 5.0 mm X 60 mm
8145-50-065	CORTICAL BONE SCR 5.0 mm X 65 mm
8145-50-070	CORTICAL BONE SCR 5.0 mm X 70 mm
8145-50-075	CORTICAL BONE SCR 5.0 mm X 75 mm
8145-50-080	CORTICAL BONE SCR 5.0 mm X 80 mm

End Caps

8145-03-000	END CAP FLUSH
8145-03-005	END CAP 5 mm
8145-03-101	IN CAP FLUSH IMPINGING

AFFIXUS Hip Fracture Nail

Product Ordering Information



AFFIXUS Hip Fracture Nail System

2112-01-000	Instrument Case 2
2112-01-001	Instrument Case 1
2112-01-800	Full Anatomy (FA) Instrument Case

General

2810-01-004	T-Handle Hudson
8261-66-000	Ratchet Screwdriver Handle Small

Entry

2112-01-100	1 - AWL
2112-01-102	2 - Entry Reamer Solid Shaft
2112-01-103	3 - Entry Reamer Flexible Shaft
2112-01-104	4 - Entry Portal
2810-13-004	5 - Entry Portal Trochar

Reduction

9030-03-004	Threaded Guide Pin 3.2 mm*
2810-01-080	Ball Nose Guidewire 80 cm*
2810-01-100	Ball Nose Guidewire 100 cm*
2810-01-001	6 - Pistol Guidewire Gripper
2810-01-026	7 - Guidewire Pusher
2810-01-007	8 - Long Reduction Tool
2142-02-012	9 - Ball Spike Pusher
2112-01-003	10 - Bone Hook
2141-19-000	11 - Femoral Bone Clamp
2810-01-175	3.2 mm x 444 mm Threaded Guide Pin Sterile*

* Products are disposable.



Nail Insertion

2112-01-106	12 - Nail Depth Gauge
2112-01-200	13 - Insertion jig 125°
2112-01-207	FA Insertion jig 125°
2112-01-201	14 - Insertion jig 130°
2112-01-208	FA Insertion jig 130°
2112-01-202	15 - Insertion jig bolt
2112-01-209	FA Insertion jig bolt
2112-01-205	Jig knob
2112-01-206	Jig knob retainer
2810-13-037	16 - Flexible jig bolt driver 8 mm
2810-13-006	Jig bolt driver 8 mm
2112-01-204	17 - Impaction tool

Lag Screw Placement

2112-01-300	18 - Lag Screw Sheath
2112-01-301	19 - Lag Screw Trochar
2112-01-302	20 - Lag Screw 3.2 mm Sleeve
2112-01-304	21 - Lag Screw Depth Gauge
2112-01-303	22 - Lag Screw Drill
2112-01-310	23 - Lag Screw Tap
2112-01-307	24 - Lag Screw Driver
2112-01-306	25 - Lag Screw Coupling Rod
2112-01-308	26 - Compression Wheel
2112-01-309	27 - 5 mm Hex Driver - Set Screw
2112-01-320	FA 5 mm Hex Driver - Set Screw
2112-01-312	28 - Guide Pin Positioning Tool

AFFIXUS Hip Fracture Nail

Product Ordering Information

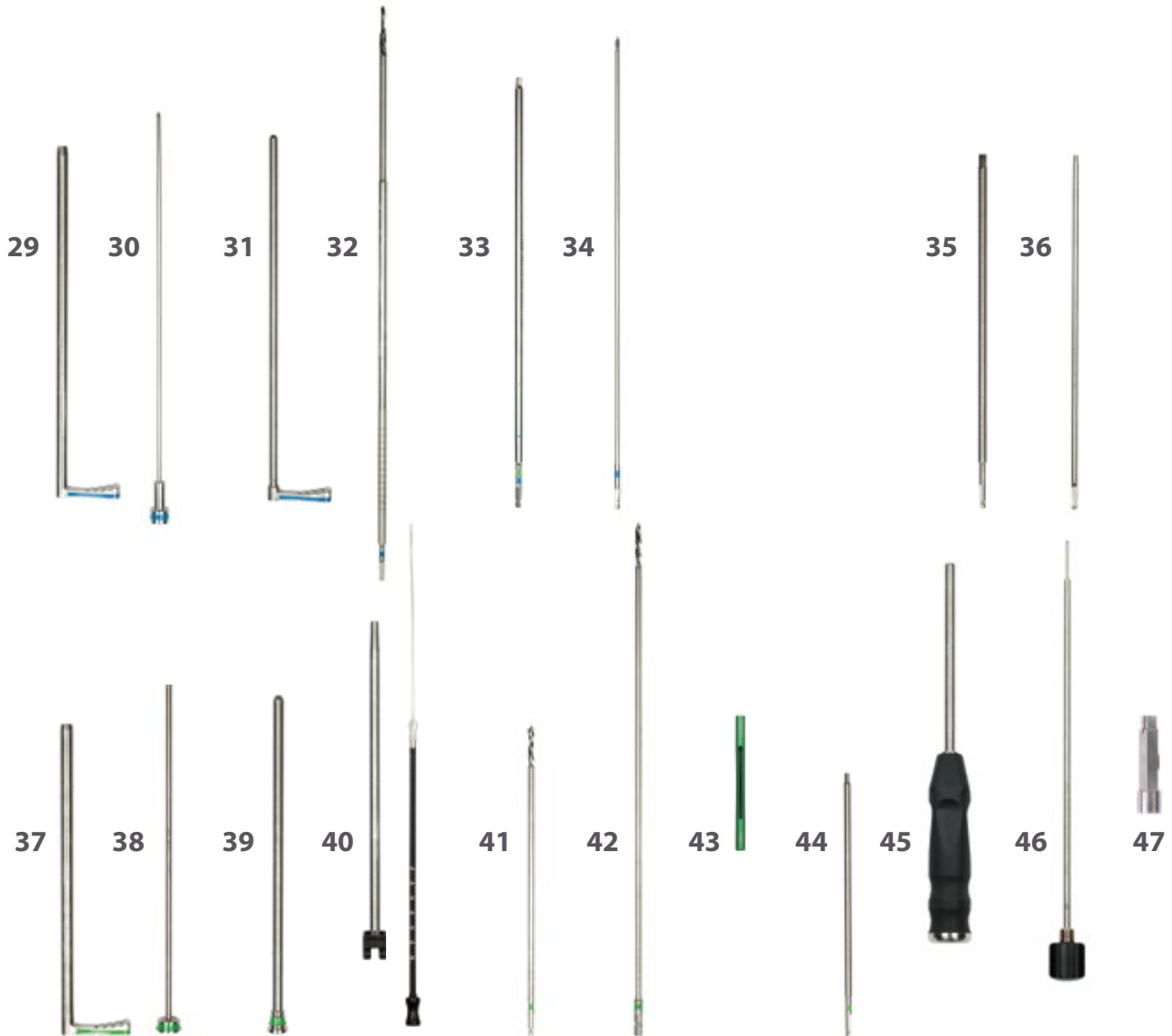

AR Screw Placement

2112-01-501	29 - A/R Screw Sheath
2112-01-502	30 - A/R Screw Trochar
2112-01-503	31 - A/R Screw 3.2 mm sleeve
2112-01-505	32 - A/R Screw Drill*
2112-01-504	33 - 3.5 mm Hex Driver Long-A/R Distal Screw
2112-01-506	34 - A/R Screw Removal Tool

End Cap Placement

2112-01-600	35 - 5 mm Hex Driver End Cap
2112-01-601	5 mm Hex Can Driver End Cap
2112-01-602	36 - End Cap Removal Tool

Distal Screw Insertion

2112-01-401	37 - Distal Screw Sheath
2112-01-402	38 - Distal Screw Trochar
2112-01-403	39 - Distal Screw Drill Sleeve
2112-01-404	40 - Distal Screw Depth Gauge
2112-01-406	41 - 4.3 mm Distal Graduated Drill Short*
2112-01-405	42 - 4.3 mm Distal Graduated Drill Long*
2112-01-410	43 - 4.3 mm Drill Measuring Sleeve*
2112-01-409	44 - 3.5 mm Hex Driver Short - Distal Screw
2810-01-020	45 - SolidLok Screwdriver Handle
2810-01-021	46 - SolidLok Driver Inner Shaft
2810-01-019	SolidLok Hex Tip 3.5 mm*
2112-01-504	33 - 3.5 mm Hex Driver Long - AR/Distal Screw

* Products are disposable.

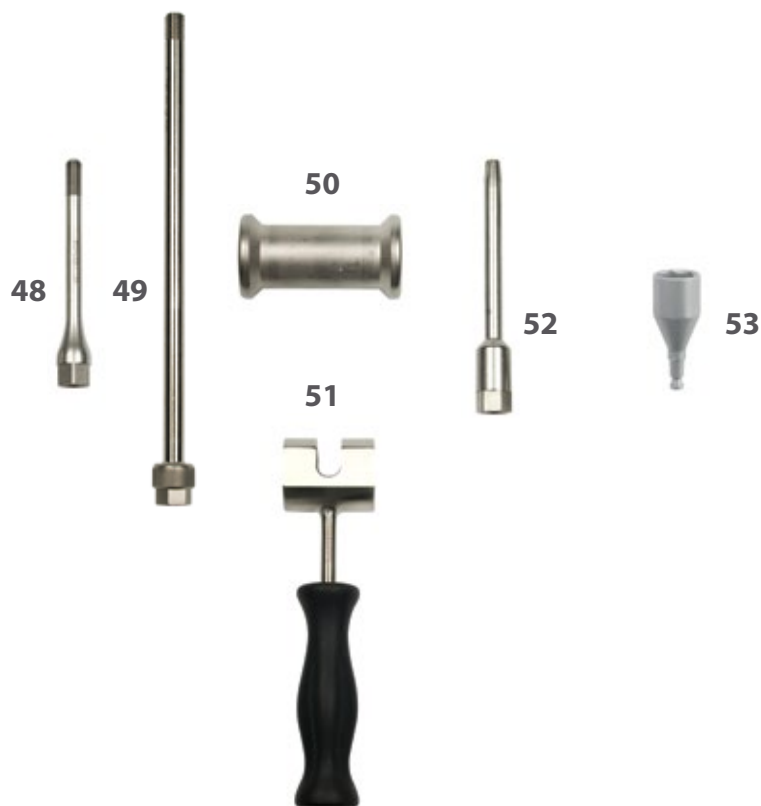

Extraction

2112-01-666	48 - Cannulated Extraction Bolt
1095	49 - Extraction Rod
1796	50 - Sliding Hammer Small
1096	Sliding Hammer Large
2112-01-606	51 - Slotted Mallet
2112-01-605	52 - Conical Extractor
2810-01-027	53 - 3/4 in Hex Driver

Flexible Reamers

2810-02-400	400 mm Nitinol Modular Reamer Hudson
2810-02-470	470 mm Nitinol Modular Reamer Hudson
2810-02-015	150 mm Reamer Extension
2810-02-081	8 mm MNBLC Endcut Reamer Hudson
2810-02-091	9 mm MNBLC Endcut Reamer Hudson
2810-04-090	9.0 mm Modular Reamer Head
2810-04-095	9.5 mm Modular Reamer Head

2810-04-100	10.0 mm Modular Reamer Head
2810-04-105	10.5 mm Modular Reamer Head
2810-04-110	11.0 mm Modular Reamer Head
2810-04-115	11.5 mm Modular Reamer Head
2810-04-120	12.0 mm Modular Reamer Head
2810-04-125	12.5 mm Modular Reamer Head
2810-04-130	13.0 mm Modular Reamer Head
2810-04-135	13.5 mm Modular Reamer Head
2810-04-140	14.0 mm Modular Reamer Head
2810-04-145	14.5 mm Modular Reamer Head
2810-04-150	15.0 mm Modular Reamer Head
2810-04-155	15.5 mm Modular Reamer Head
2810-04-160	16.0 mm Modular Reamer Head
2810-04-165	16.5 mm Modular Reamer Head
2810-04-170	17.0 mm Modular Reamer Head

Important:

This Essential Product Information does not include all of the information necessary for selection and use of a device. Please see full labeling for all necessary information.

The use of metallic surgical appliances (screws, plates, intramedullary nails, compression hip screws, pins and wires) provides the orthopaedic surgeon a means of bone fixation and helps generally in the management of fractures and reconstructive surgeries. These implants are intended as a guide to normal healing, and are NOT intended to replace normal body structure or bear the weight of the body in the presence of incomplete bone healing. Delayed unions or nonunions in the presence of load bearing or weight bearing might eventually cause the implant to break due to metal fatigue. All metal surgical implants are subjected to repeated stress in use, which can result in metal fatigue.

Indications

The AFFIXUS Hip Fracture Nail is intended to treat stable and unstable proximal fractures of the femur including pertrochanteric fractures, intertrochanteric fractures, high subtrochanteric fractures and combinations of these fractures, including non-union, malunion and tumor resections. The Long Nail system is additionally indicated to treat pertrochanteric fractures associated with shaft fractures, pathologic fractures in osteoporotic bone (including prophylactic use) of the trochanteric and diaphyseal areas, impending pathological fractures, long subtrochanteric fractures, ipsilateral femoral fractures, proximal or distal non-unions, malunions, revision procedures and tumor resections

Contraindications:

Screws, plates, intramedullary nails, compression hip screws, pins and wires are contraindicated in: active infection, conditions which tend to retard healing such as blood supply limitations, previous infections, insufficient quantity or quality of bone to permit stabilization of the fracture complex, conditions that restrict the patient's ability or willingness to follow postoperative instructions during the healing process, foreign body sensitivity, and cases where the implant(s) would cross open epiphyseal plates in skeletally immature patients.

This material is intended for healthcare professionals and the Zimmer Biomet sales force. Distribution to any other recipient is prohibited. For indications, contraindications, warnings, precautions, potential adverse effects and patient counseling information, see the package insert or contact your local representative; visit www.zimmerbiomet.com for additional product information. All content herein is protected by copyright, trademarks and other intellectual property rights, as applicable, owned by or licensed to Zimmer Biomet or its affiliates unless otherwise indicated, and must not be redistributed, duplicated or disclosed, in whole or in part, without the express written consent of Zimmer Biomet.

For indications, contraindications, warnings, precautions, potential adverse effects and patient counseling information, see the package insert or contact your local representative; visit www.zimmerbiomet.com for additional product information. Check for country product clearances and reference product specific instructions for use. Zimmer Biomet does not practice medicine. This technique was developed in conjunction with health care professional. This document is intended for surgeons and is not intended for laypersons. Each surgeon should exercise his or her own independent judgment in the diagnosis and treatment of an individual patient, and this information does not purport to replace the comprehensive training surgeons have received. As with all surgical procedures, the technique used in each case will depend on the surgeon's medical judgment as the best treatment for each patient. Results will vary based on health, weight, activity and other variables. Not all patients are candidates for this product and/or procedure. Caution: Federal (USA) law restricts this device to sale by or on the order of a surgeon. Rx only.

©2014 Biomet Trauma, 2021 Zimmer Biomet



Form No. BMET0022.1-GBL • Issue Date 2021-12-16

Additional Contraindication for Orthopaedic Screws and Plates only:

Cases with malignant primary or metastatic tumors which preclude adequate bone support or screw fixations, unless supplemental fixation or stabilization methods are utilized.

Additional Contraindication for Retrograde Femoral Nailing:

A history of septic arthritis of the knee and knee extension contracture with inability to attain at least 45° of flexion.

Additional Contraindications for Compression Hip Screws only:

Inadequate implant support due to the lack of medial buttress.

Warnings and Precautions:

Bone screws and pins are intended for partial weight bearing and non-weight bearing applications. These components cannot be expected to withstand the unsupported stresses of full weight bearing.

Adverse Events:

The following are the most frequent adverse events after fixation with orthopaedic screws, plates, intramedullary nails, compression hip screws, pins and wires: loosening, bending, cracking or fracture of the components or loss of fixation in bone attributable to nonunion, osteoporosis, markedly unstable comminuted fractures; loss of anatomic position with nonunion or malunion with rotation or angulation; infection and allergies and adverse reactions to the device material. Surgeons should take care when targeting and drilling for the proximal screws in any tibial nail with oblique proximal screws. Care should be taken as the drill bit is advanced to penetrate the far cortex. Advancing the drill bit too far in this area may cause injury to the deep peroneal nerve. Fluoroscopy should be used to verify correct positioning of the drill bit.

Additional Adverse Events for Compression Hip Screw only:

Screw cutout of the femoral head (usually associated with osteoporotic bone).

 **Legal Manufacturer**
Biomet Trauma
56 East Bell Drive
P.O. Box 587
Warsaw, Indiana 46581
USA

CE2797

www.zimmerbiomet.com