

Taperloc® Complete

Hip System

Surgical Technique



Table of Contents

- Patient Positioning and Surgical Approach** 1
- Accessing the Femoral Canal**..... 2
- Femoral Canal Preparation**..... 3
- Trial Reduction** 4
- Stem Insertion** 5
- Final Reduction** 5
- Offsets and Neck Lengths** 6
 - Taperloc Complete Hip Stem Standard Offset 6
 - Taperloc Complete Hip Stem High Offset..... 6
 - Taperloc Complete Hip Stem XR 123° stem..... 7

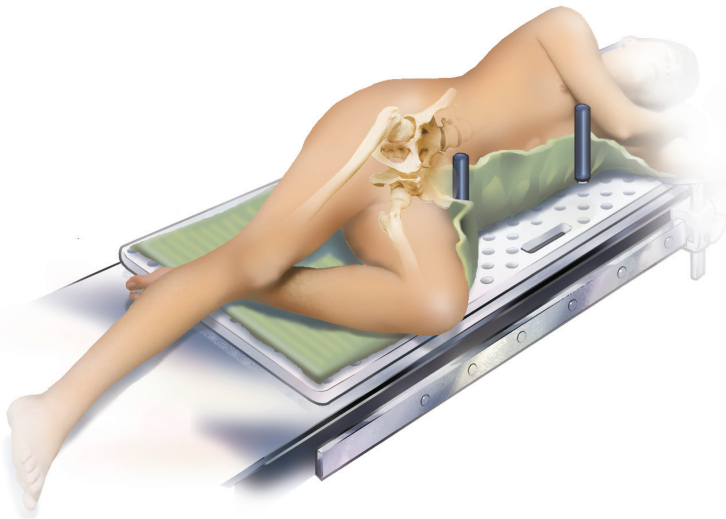

Figure 1

Patient Positioning and Surgical Approach

The goal of the surgical approach is to establish adequate visualization of the anatomy to evaluate stability and leg length. A number of surgical approaches to the hip can be utilized based on the degree of surgical experience and preference such as the anterolateral approach shown (Figure 1).

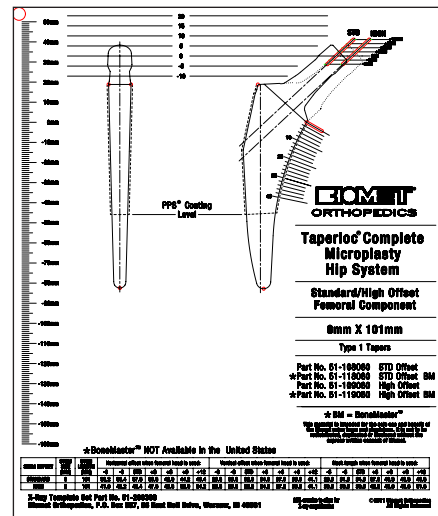
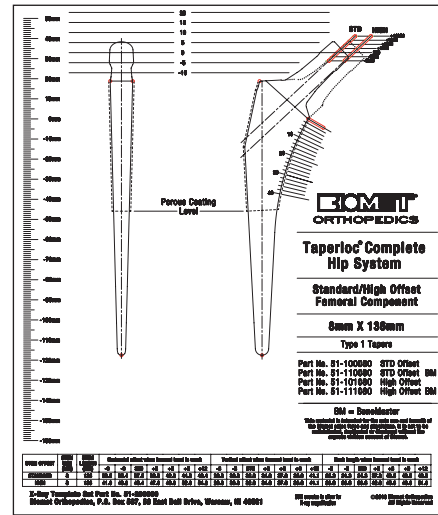

Figure 2

Preoperative templates are provided to help determine component size, femoral neck resection level and appropriate neck length (Figure 2). Radiographs should include a full A/P (anterior/posterior) view of the pelvis, including the proximal one-half of both femurs and a lateral view of the proximal half of the affected femur.

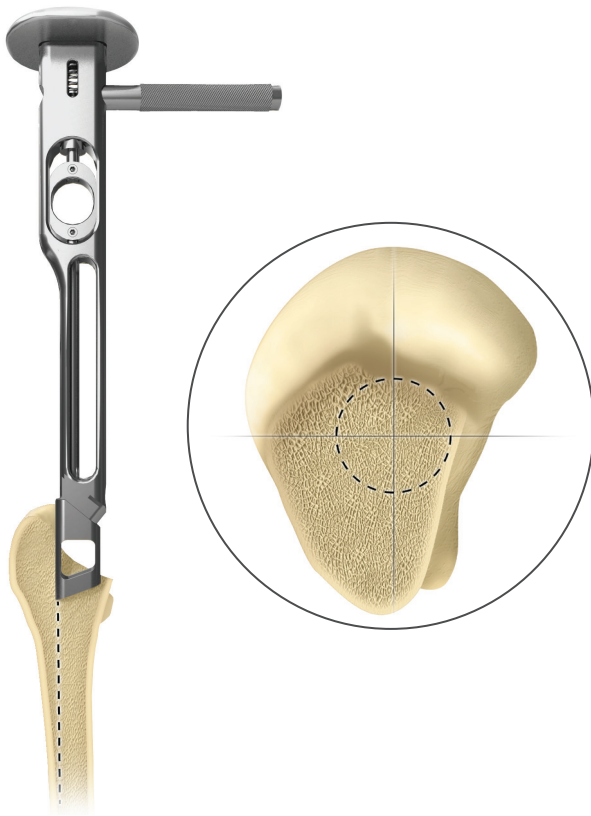

Figure 3



Figure 4

Accessing the Femoral Canal

Using the surgeon's preferred technique, resect the femoral head. Access the femoral canal with the straight or offset boxed chisel to determine the orientation of the femoral canal and access the lateral section of the proximal femur. This helps clearing the femoral canal postero-laterally to accept the starter reamer without interference from the dense bone surrounding the trochanter. The straight or offset boxed chisels were designed to allow enough lateralization of the femoral canal to help reduce the risk of varus positioning of the component (Figure 3).

A single starter reamer on a T-handle may be used to initiate the opening into the distal femoral canal (Figure 4).

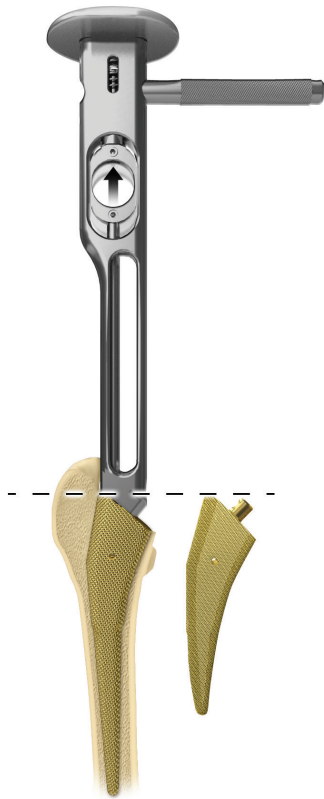

Figure 5

Femoral Canal Preparation

When preparing the proximal femur, use care with the insertion and removal of each broach to avoid rotation and to preserve the version of the femoral canal.

Select the smallest sized Taperloc Complete broach and attach it to the broach handle by pulling back on the trigger to engage the broach (Figure 5). Orientation of the broach should take into account the medial/lateral and anterior/posterior position of the medullary canal. Progressively increase the broach size to enlarge the canal until the broach engages the medial and lateral cortex and cannot be advanced deeper.

- ⓘ **Note:** When impacting the broach handle, ensure that impaction occurs on the strike plate, as opposed to the threaded handle adaptor.
- ⓘ **Note:** When preparing for the Taperloc Complete Microplasty[®] stem placement, be sure to use the appropriate broach as shown above (Figure 5). Insertion technique is the same for both Taperloc Complete broaches and stems.
- ⓘ **Note:** If the final broach size is less than the templated size, carefully determine that the broach is achieving a tight proximal fit and is not in varus position.

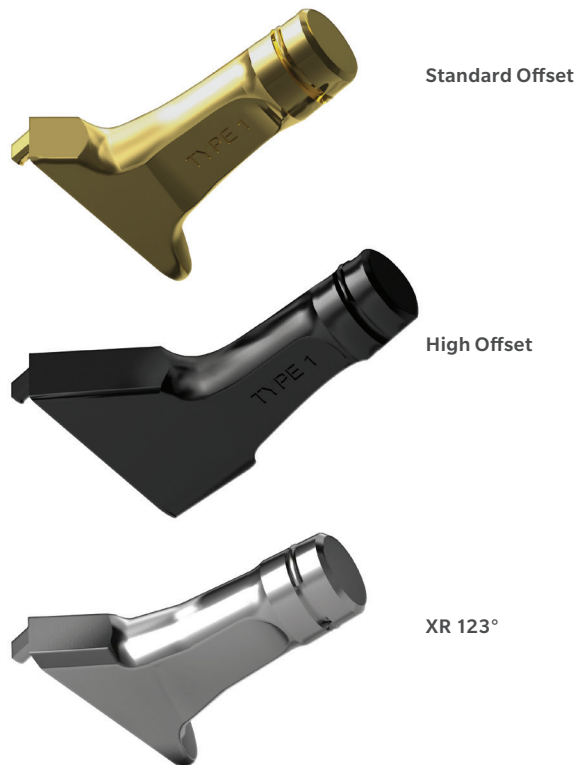

Figure 6



Figure 7i

Trial Reduction

To perform a trial reduction with the fully seated broach, attach the appropriate Taperloc Complete magnetic neck trunnion onto the broach post. The magnetic trunnions are sized to correspond to the final broach, and the stem size is clearly marked on the top of the trunnion (Figure 6).

Note: The Taperloc Complete full length and Microplasty stem options use the same neck trunnions.

Once the appropriate trunnion is in place, select the trial femoral head of desired diameter and neck length. Reduce the hip and evaluate the joint for soft tissue tension, anterior and posterior stability. If necessary, any additional adjustments to neck length and/or offset can be completed at this stage (Figure 7).



Figure 8

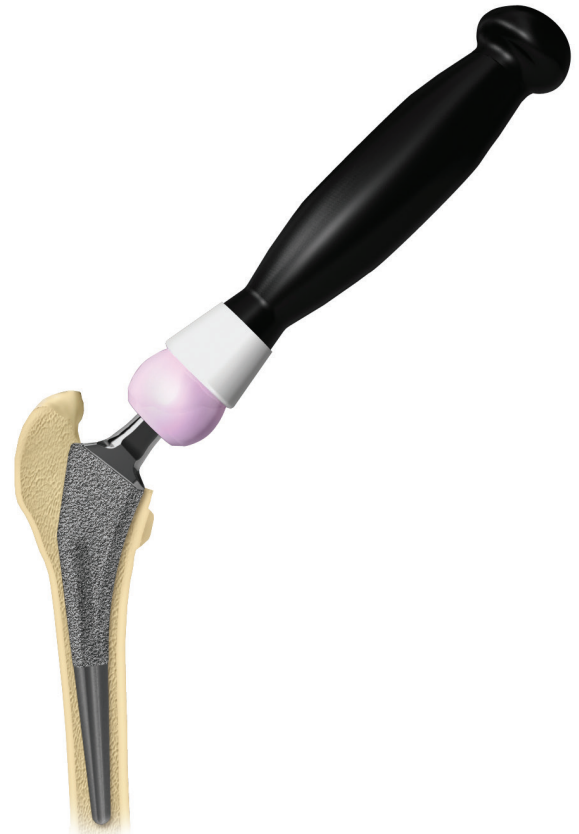

Figure 9

Stem Insertion

Once the trial reduction is considered stable, remove the broach from the femoral canal and attach the implant to the blunt-tip femoral inserter, aligning the tab on the tip of the inserter to the indentation on the implant (Figure 8). The femoral inserter handle assists in controlling rotation of the implant and enables the implant to be inserted into the femoral canal with the proper amount of anteversion.

Make sure to orient the implant parallel to the prepared envelope, matching the appropriate amount of anteversion determined during broaching. The stem should slide distally into the canal without excessive resistance until the implant engages the lateral and medial walls.

Gently tap the stem inserter to seat the prosthesis until there is an audible change in pitch to verify that the implant is fully seated.

Note: The Taperloc Complete stem is designed to achieve a tight press-fit in the femoral canal and thus should sit flush or slightly proud relative to the broach.

Final Reduction

If desired, another trial reduction can be accomplished prior to selecting the final head size and impacting the modular head onto the femoral implant. Provisional heads in seven neck lengths allow an additional trial reduction using the actual implant to ensure proper leg length and stability. After fully seating the femoral component, impact the appropriate modular head onto the clean, dry taper (Figure 9).

Note: All Biomet Type I modular heads are compatible with Taperloc Complete hip stems except the Zirconia ceramic modular heads.

*12/14 Taperloc Complete stems are not available in the United States

Offsets and Neck Lengths

Taperloc Complete Hip Stem Standard Offset

Size	Taperloc Complete Stem Length (mm)	Taperloc Complete Microplasty Stem Length (mm)	Neck Angle	Horizontal Offset (mm)								Vertical Offset (mm)								Neck Length (mm)							
				-6	-3	STD	+3	+6	+9	+12	-6	-3	STD	+3	+6	+9	+12	-6	-3	STD	+3	+6	+9	+12			
4	128	93	133°	31.2	33.4	35.6	37.8	40.0	42.2	44.4	28.8	30.8	32.9	34.9	37.0	39.0	41.1	28.3	31.3	34.3	37.3	40.3	43.3	46.3			
5	130	95	133°	31.7	33.9	36.1	38.3	40.5	42.7	44.9	28.8	30.8	32.9	34.9	37.0	39.0	41.1	28.3	31.3	34.3	37.3	40.3	43.3	46.3			
6	132	97.5	133°	32.2	34.4	36.6	38.8	41.0	43.2	45.4	28.8	30.8	32.9	34.9	37.0	39.0	41.1	28.3	31.3	34.3	37.3	40.3	43.3	46.3			
7	134	99	133°	32.7	34.9	37.1	39.3	41.5	43.7	45.9	28.8	30.8	32.9	34.9	37.0	39.0	41.1	28.3	31.3	34.3	37.3	40.3	43.3	46.3			
8	136	101	133°	33.2	35.4	37.6	39.8	42.0	44.2	46.4	28.8	30.8	32.9	34.9	37.0	39.0	41.1	28.3	31.3	34.3	37.3	40.3	43.3	46.3			
9	137	102.5	133°	33.7	35.9	38.1	40.3	42.5	44.7	46.8	28.8	30.8	32.9	34.9	37.0	39.0	41.1	28.3	31.3	34.3	37.3	40.3	43.3	46.3			
10	140	105	133°	34.2	36.4	38.6	40.8	43.0	45.2	47.4	28.8	30.8	32.9	34.9	37.0	39.0	41.1	28.3	31.3	34.3	37.3	40.3	43.3	46.3			
11	142	107.5	133°	34.7	36.9	39.1	41.3	43.5	45.7	47.9	28.8	30.8	32.9	34.9	37.0	39.0	41.1	28.3	31.3	34.3	37.3	40.3	43.3	46.3			
12	144	109	133°	35.2	37.4	39.6	41.8	44.0	46.2	48.3	28.8	30.8	32.9	34.9	37.0	39.0	41.1	28.3	31.3	34.3	37.3	40.3	43.3	46.3			
13	146	111	133°	35.7	37.9	40.1	42.3	44.5	46.7	48.9	28.8	30.8	32.9	34.9	37.0	39.0	41.1	28.3	31.3	34.3	37.3	40.3	43.3	46.3			
14	148	113	133°	36.2	38.4	40.6	42.8	45.0	47.2	49.4	28.8	30.8	32.9	34.9	37.0	39.0	41.1	28.3	31.3	34.3	37.3	40.3	43.3	46.3			
15	150	115	133°	36.7	38.9	41.1	43.3	45.5	47.7	49.9	28.8	30.8	32.9	34.9	37.0	39.0	41.1	28.3	31.3	34.3	37.3	40.3	43.3	46.3			
16	152	117	133°	37.2	39.4	41.6	43.8	46.0	48.2	50.4	28.8	30.8	32.9	34.9	37.0	39.0	41.1	28.3	31.3	34.3	37.3	40.3	43.3	46.3			
17	154	119	133°	37.7	39.9	42.1	44.3	46.5	48.7	50.9	28.8	30.8	32.9	34.9	37.0	39.0	41.1	28.3	31.3	34.3	37.3	40.3	43.3	46.3			
18	156	121	133°	40.4	42.6	44.8	47.0	49.2	51.4	53.6	30.8	32.9	34.9	37.0	39.0	41.1	43.1	31.3	34.3	37.3	40.3	43.3	46.3	49.3			
20	160	125	133°	41.4	43.6	45.8	48.0	50.2	52.4	54.5	30.8	32.9	34.9	37.0	39.0	41.1	43.1	31.3	34.3	37.3	40.3	43.3	46.3	49.3			
22	164	129	133°	42.4	44.6	46.8	49.0	51.1	53.3	55.5	30.8	32.9	34.9	37.0	39.0	41.1	43.1	31.3	34.3	37.3	40.3	43.3	46.3	49.3			
24	167	132	133°	43.4	45.6	47.8	50.0	52.2	54.4	56.6	30.8	32.9	34.9	37.0	39.0	41.1	43.1	31.3	34.3	37.3	40.3	43.3	46.3	49.3			

Taperloc Complete Hip Stem High Offset

Size	Taperloc Complete Stem Length (mm)	Taperloc Complete Microplasty Stem Length (mm)	Neck Angle	Horizontal Offset (mm)								Vertical Offset (mm)								Neck Length (mm)							
				-6	-3	STD	+3	+6	+9	+12	-6	-3	STD	+3	+6	+9	+12	-6	-3	STD	+3	+6	+9	+12			
5	130	95	133°	39.5	41.7	43.9	46.1	48.3	50.5	52.7	28.8	30.8	32.9	34.9	37.0	39.0	41.1	33.6	36.6	39.6	42.6	45.6	48.6	51.6			
6	132	97.5	133°	40.0	42.2	44.4	46.6	48.8	51.0	53.2	28.8	30.8	32.9	34.9	37.0	39.0	41.1	33.6	36.6	39.6	42.6	45.6	48.6	51.6			
7	134	99	133°	40.5	42.7	44.9	47.1	49.3	51.5	53.7	28.8	30.8	32.9	34.9	37.0	39.0	41.1	33.6	36.6	39.6	42.6	45.6	48.6	51.6			
8	136	101	133°	41.0	43.2	45.4	47.6	49.8	52.0	54.2	28.8	30.8	32.9	34.9	37.0	39.0	41.1	33.6	36.6	39.6	42.6	45.6	48.6	51.6			
9	137	102.5	133°	41.5	43.7	45.9	48.1	50.3	52.5	54.7	28.8	30.8	32.9	34.9	37.0	39.0	41.1	33.6	36.6	39.6	42.6	45.6	48.6	51.6			
10	140	105	133°	42.0	44.2	46.4	48.6	50.8	53.0	55.2	28.8	30.8	32.9	34.9	37.0	39.0	41.1	33.6	36.6	39.6	42.6	45.6	48.6	51.6			
11	142	107.5	133°	42.5	44.7	46.9	49.1	51.3	53.5	55.7	28.8	30.8	32.9	34.9	37.0	39.0	41.1	33.6	36.6	39.6	42.6	45.6	48.6	51.6			
12	144	109	133°	43.0	45.2	47.4	49.6	51.8	54.0	56.2	28.8	30.8	32.9	34.9	37.0	39.0	41.1	33.6	36.6	39.6	42.6	45.6	48.6	51.6			
13	146	111	133°	43.5	45.7	47.9	50.1	52.3	54.5	56.7	28.8	30.8	32.9	34.9	37.0	39.0	41.1	33.6	36.6	39.6	42.6	45.6	48.6	51.6			
14	148	113	133°	44.0	46.2	48.4	50.6	52.8	55.0	57.2	28.8	30.8	32.9	34.9	37.0	39.0	41.1	33.6	36.6	39.6	42.6	45.6	48.6	51.6			
15	150	115	133°	44.5	46.7	48.9	51.1	53.3	55.5	57.7	28.8	30.8	32.9	34.9	37.0	39.0	41.1	33.6	36.6	39.6	42.6	45.6	48.6	51.6			
16	152	117	133°	45.0	47.2	49.4	51.6	53.8	56.0	58.2	28.8	30.8	32.9	34.9	37.0	39.0	41.1	33.6	36.6	39.6	42.6	45.6	48.6	51.6			
17	154	119	133°	45.5	47.7	49.9	52.1	54.3	56.5	58.7	28.8	30.8	32.9	34.9	37.0	39.0	41.1	33.6	36.6	39.6	42.6	45.6	48.6	51.6			
18	156	121	133°	48.2	50.4	52.6	54.8	57.0	59.2	61.4	30.8	32.9	34.9	37.0	39.0	41.1	43.1	36.6	39.6	42.6	45.6	48.6	51.6	54.6			
20	160	125	133°	49.2	51.4	53.6	55.8	58.0	60.2	62.4	30.8	32.9	34.9	37.0	39.0	41.1	43.1	36.6	39.6	42.6	45.6	48.6	51.6	54.6			
22	164	129	133°	50.2	52.4	54.6	56.8	59.0	61.2	63.4	30.8	32.9	34.9	37.0	39.0	41.1	43.1	36.6	39.6	42.6	45.6	48.6	51.6	54.6			
24	167	132	133°	51.2	53.4	55.6	57.8	60.0	62.2	64.4	30.8	32.9	34.9	37.0	39.0	41.1	43.1	36.6	39.6	42.6	45.6	48.6	51.6	54.6			

Offsets and Neck Lengths (cont.)

Taperloc Complete XR 123° Stem

Size	Taperloc Complete Stem Length (mm)	Taperloc Complete Microplasty Stem Length (mm)	Neck Angle	Neck Length (mm)	Horizontal Offset (mm)								Vertical Offset (mm)								Neck Length (mm)							
					-6	-3	STD	+3	+6	+9	+12	-6	-3	STD	+3	+6	+9	+12	-6	-3	STD	+3	+6	+9	+12			
4	128	93	123°	32.3	32.8	35.3	37.8	40.3	42.8	45.3	47.9	23.6	25.3	26.9	28.5	30.2	31.8	33.4	26.3	29.3	32.3	35.3	38.3	41.3	44.3			
5	130	95	123°	32.3	33.3	35.8	38.3	40.8	43.3	45.8	48.4	23.6	25.3	26.9	28.5	30.2	31.8	33.4	26.3	29.3	32.3	35.3	38.3	41.3	44.3			
6	132	97.5	123°	32.3	33.8	36.3	38.8	41.3	43.8	46.3	48.9	23.6	25.3	26.9	28.5	30.2	31.8	33.4	26.3	29.3	32.3	35.3	38.3	41.3	44.3			
7	134	99	123°	32.3	34.3	36.8	39.3	41.8	44.3	46.8	49.4	23.6	25.3	26.9	28.5	30.2	31.8	33.4	26.3	29.3	32.3	35.3	38.3	41.3	44.3			
8	136	101	123°	32.3	34.8	37.3	39.8	42.3	44.8	47.3	49.9	23.6	25.3	26.9	28.5	30.2	31.8	33.4	26.3	29.3	32.3	35.3	38.3	41.3	44.3			
9	137	102.5	123°	32.3	35.3	37.8	40.3	42.8	45.3	47.8	50.4	23.6	25.3	26.9	28.5	30.2	31.8	33.4	26.3	29.3	32.3	35.3	38.3	41.3	44.3			
10	140	105	123°	32.3	35.8	38.3	40.8	43.3	45.8	48.3	50.9	23.6	25.3	26.9	28.5	30.2	31.8	33.4	26.3	29.3	32.3	35.3	38.3	41.3	44.3			
11	142	107.5	123°	32.3	36.3	38.8	41.3	43.8	46.3	48.8	51.4	23.6	25.3	26.9	28.5	30.2	31.8	33.4	26.3	29.3	32.3	35.3	38.3	41.3	44.3			
12	144	109	123°	32.3	36.8	39.3	41.8	44.3	46.8	49.3	51.9	23.6	25.3	26.9	28.5	30.2	31.8	33.4	26.3	29.3	32.3	35.3	38.3	41.3	44.3			
13	146	111	123°	32.3	37.3	39.8	42.3	44.8	47.3	49.8	52.4	23.6	25.3	26.9	28.5	30.2	31.8	33.4	26.3	29.3	32.3	35.3	38.3	41.3	44.3			
14	148	113	123°	32.3	37.8	40.3	42.8	45.3	47.8	50.3	52.9	23.6	25.3	26.9	28.5	30.2	31.8	33.4	26.3	29.3	32.3	35.3	38.3	41.3	44.3			
15	150	115	123°	32.3	38.3	40.8	43.3	45.8	48.3	50.8	53.4	23.6	25.3	26.9	28.5	30.2	31.8	33.4	26.3	29.3	32.3	35.3	38.3	41.3	44.3			
16	152	117	123°	32.3	38.8	41.3	43.8	46.3	48.8	51.3	53.9	23.6	25.3	26.9	28.5	30.2	31.8	33.4	26.3	29.3	32.3	35.3	38.3	41.3	44.3			
17	154	119	123°	32.3	39.3	41.8	44.3	46.8	49.3	51.8	54.4	23.6	25.3	26.9	28.5	30.2	31.8	33.4	26.3	29.3	32.3	35.3	38.3	41.3	44.3			
18	156	121	123°	32.3	39.8	42.3	44.8	47.3	49.8	52.3	54.9	23.6	25.3	26.9	28.5	30.2	31.8	33.4	26.3	29.3	32.3	35.3	38.3	41.3	44.3			

All content herein is protected by copyright, trademarks and other intellectual property rights, as applicable, owned by or licensed to Zimmer Biomet or its affiliates unless otherwise indicated, and must not be redistributed, duplicated or disclosed, in whole or in part, without the express written consent of Zimmer Biomet.

This material is intended for health care professionals. Distribution to any other recipient is prohibited.

For product information, including indications, contraindications, warnings, precautions, potential adverse effects and patient counseling information, see the package insert and www.zimmerbiomet.com.

Zimmer Biomet does not practice medicine. This technique was developed in conjunction with health care professionals. This document is intended for surgeons and is not intended for laypersons. Each surgeon should exercise his or her own independent judgment in the diagnosis and treatment of an individual patient, and this information does not purport to replace the comprehensive training surgeons have received. As with all surgical procedures, the technique used in each case will depend on the surgeon's medical judgment as the best treatment for each patient. Results will vary based on health, weight, activity and other variables. Not all patients are candidates for this product and/or procedure. Caution: Federal (USA) law restricts this device to sale by or on the order of a surgeon. Rx only.

Check for country product clearances and reference product specific instructions for use. Not for distribution in France.

© 2018, 2021 Zimmer Biomet.



 **Legal Manufacturer**
Biomet Orthopedics
56 E. Bell Drive
P.O. Box 587
Warsaw, Indiana 46581-0587
USA

www.zimmerbiomet.com



CE mark on a surgical technique is not valid unless there is a CE mark on the product label.