



User's Information Manual



instinct & instinct FSB

SOLO 110-155-199 & COMBI 155-199

⚠ NOTICE

- Customer must register unit within thirty (30) days of installation in order to gain warranty coverage. See Warranty Card for details.
- Leave all documentation received with appliance with the owner for future reference.

⚠ WARNING

- To maintain the safety & longevity of your appliance, read and follow the maintenance schedule information throughout this manual.
- If the information in this manual is not followed exactly, a fire or explosion may result causing substantial property damage, serious injury, or death.
- **WHAT TO DO IF YOU SMELL GAS**
 - Do not try to light any appliance
 - Do not touch any electrical switch; do not use any phone in your building.
 - Immediately call your gas supplier from a neighbor's phone. Follow the gas supplier's instructions.
 - If you cannot reach your gas supplier, call the fire department.

FOR YOUR SAFETY

- Do not store or use gasoline or other flammable vapors and liquids in the vicinity of this or any other appliance.
- Installation and service must be performed by a qualified installer, service agency or the gas supplier.



INTENTIONALLY LEFT BLANK

TABLE OF CONTENTS

SAFETY INFORMATION	V
PRODUCT AND SAFETY INFORMATION.....	VI
PRODUCT AND SAFETY INFORMATION.....	VII
CHAPTER 1 - COMBUSTION AIR CONTAMINATION.....	1
CHAPTER 2 - MAINTENANCE SCHEDULES	3
2.1. Service Technician	3
2.2. Owner Maintenance.....	3
CHAPTER 3 - MAINTENANCE PROCEDURES	5
3.1. Owner Maintenance Procedures	5
3.2. Daily Maintenance.....	5
3.2.1 Check Surrounding Area	5
3.2.2 Check Ventilation Air Openings.....	5
3.2.3 Check Temperature Display and Pressure Gauge.....	6
3.2.4 Check CO Detectors.....	6
3.3. Monthly Maintenance	6
3.3.1 Check Vent and Combustion Air Piping	6
3.3.2 Check Pressure Relief Valve	6
3.3.3 Check Condensate Drain System	7
3.4. 6-Month Maintenance	8
3.4.1 Check Water and Gas Piping	8
3.4.2 Operate Pressure Relief Valve.....	8
CHAPTER 4 - OPERATING INSTRUCTIONS	9
CHAPTER 5 - CTRLMAX OPERATION	11
5.1. CTRLMax Navigation	11
5.2. CTRLMax Menu Structure.....	12
5.3. Home Screen.....	13
5.4. Status Line Messages.....	14
5.5. Main Menu	15
5.6. EZ Setup	15
5.7. CH / DHW Operation	16
5.8. Language Selection	17
5.9. Boiler Information	18
5.9.1 Information Items.....	19
5.10. Lockout History	20
5.10.1 Lockout Screen.....	21
5.10.2 Manual Reset Lockouts.....	22
5.10.3 Automatic Reset Blocking Lockouts.....	23

INDEX OF ILLUSTRATIONS

Fig. 1 - Condensate Drain Assembly.....	7
Fig. 2 - Condensate Retention Clip - (Solo Models only)	7
Fig. 3 - CTRLMax User Interface.....	11

SAFETY INFORMATION

CARBON MONOXIDE ALARMS

This product burns gas to produce heat. The appliance must be properly installed, operated, and maintained to avoid exposure to appreciable levels of carbon monoxide and the installer is required to confirm that at least one carbon monoxide alarm is installed in the living space before the appliance is put into operation. It is important for the carbon monoxide alarms to be installed, maintained, and replaced following the alarm manufacturer's instructions and applicable local codes.

Further to this all installed carbon monoxide alarms must comply with NFPA 720, be ANSI/UL 2034 listed, and be IAS certified. They must also be hardwired with battery backups. If it is not possible at the time of installation to have hardwired alarms battery operated alarms are allowable for up to 30 days before being replaced with hardwired alarms with battery backups.

Make sure that the carbon monoxide alarms are installed by professionals that inform you of all the maintenance required to keep the carbon monoxide alarms functional.

Consumer Product Safety Commission (CPSC) recommendations

- Some signs of problems with the appliance that the CPSC recommends being aware of are:
 - Decreased hot water supply
 - Boiler unable to heat house or runs continuously
 - Sooting, especially on appliances and vents
 - Unfamiliar, or burner odor
 - Increased moisture inside of windows

If any of these issues are seen reduce the use of the appliance to what is necessary and contact a qualified service technician immediately for corrective maintenance. The longer these issues are present the more at risk of carbon monoxide poisoning you are.

Common initial symptoms of carbon monoxide poisoning are flu like (but without the fever), they include:

- Headache
- Fatigue
- Shortness of breath
- Nausea
- Dizziness

If you suspect that you are experiencing carbon monoxide poisoning, get fresh air immediately. Leave the home and call for assistance from a neighbor's home. You could lose consciousness and die from carbon monoxide poisoning if you stay in the home.

Get medical attention immediately and inform medical staff that carbon monoxide poisoning is suspected. Call the Fire Department to determine when it is safe to re-enter the home.

For further information on carbon monoxide and its effects go to:

- <https://www.cpsc.gov/safety-education/safety-guides/carbon-monoxide/invisible-killer>
- <https://www.cpsc.gov/safety-education/safety-guides/carbon-monoxide/carbon-monoxide-fact-sheet>

PRODUCT AND SAFETY INFORMATION

IMPORTANT SAFETY INFORMATION FOR THE HOMEOWNER AND THE TECHNICIAN

This manual contains important information with respect to the operation and maintenance of the appliance.

This manual must be provided to the Homeowner, who will keep it in a safe place for future reference.

Triangle Tube accepts no liability for any damage, injury, or loss of life resulting from incorrect installation, alteration of any factory supplied parts, or the use of parts or fittings not specified by Triangle Tube. If there is a conflict or doubt about the proper installation of the unit or any factory supplied replacement parts please contact Triangle Tube Technical Support.

DEFINITIONS

The following terms are used throughout this manual to bring attention to the presence of potential hazards or to important information concerning the product.

DANGER

Indicates the presence of a hazardous situation which, if ignored, will result in substantial property damage, serious injury, or death.

WARNING

Indicates a potentially hazardous situation which, if ignored, can result in substantial property damage, serious injury, or death.

CAUTION

Indicates a potentially hazardous situation which, if ignored, can result in minor property damage, or injury.

NOTICE

Indicates special instructions on installation, operation or maintenance, which are important to the equipment but not related to personal injury hazards.

BEST PRACTICE

Indicates recommendations made by Triangle Tube for the installers, which will help to ensure optimum operation and longevity of the equipment.

STOP !

READ BEFORE SERVICING

Failure to adhere to the guidelines within this manual can result in substantial property damage, serious injury, or death.

TECHNICIAN: When calling or writing about the INSTINCT, please have the boiler model and serial number available.

DANGER

- Do not use this appliance if any part has been under water. Immediately call a qualified service technician to inspect the appliance and to replace any part of the control system which has been under water.
- Avoid electrical shock when servicing the appliance, by disconnecting the electrical supply prior to performing service or maintenance.
- Failure to comply with these instructions will result in substantial property damage, serious injury, or death.

WARNING

- The INSTINCT Installation manual is for use only by a qualified heating installer/service technician. The homeowner will use this User's Information Manual for reference.
- What to do if you smell gas:
 - Do not try to light any appliance
 - Do not touch any electrical switch; do not use any phone in your building.
 - Immediately call your gas supplier from a neighbor's phone. Follow the gas supplier's instructions.
 - If you cannot reach your gas supplier, call the fire department.
- Do not store or use gasoline or other flammable vapors and liquids in the vicinity of this or any other appliance.
- Prior to installing this product, the qualified installer must read all instructions included in this manual and all accompanying manuals/ documents with this appliance.
- All installation steps required in these manuals must be performed in the proper order given.
- This product must be maintained / serviced and inspected annually by a qualified service technician.
- Failure to comply with these instructions can result in substantial property damage, serious injury, or death.

PRODUCT AND SAFETY INFORMATION

- A byproduct of any gas fired appliance is carbon monoxide. It is required that at least two hardwired carbon monoxide alarms with battery backups are installed before the installation or operation of the appliance. One in the mechanical room where the appliance is located and another on each floor of the dwelling. For all carbon monoxide requirements see section 2.7 of the installation and Maintenance Manual or section 1.1 of the vent supplement. Consult the local authority having jurisdiction for any additional local requirements in your area. See section 2.8 of the Installation and Maintenance Manual or Chapter 5 of the vent supplement for additional requirements in Massachusetts.
- Failure to comply with these instructions can result in substantial property damage, serious injury, or death.

Service and Maintenance:

- Allow the unit to cool down prior to servicing to avoid severe burns.
- The INSTINCT must be maintained as outlined in this manual and have at least annual service performed by a qualified service technician to ensure unit / system reliability.

INSTINCT Operation

- Do not block flow of combustion air to the INSTINCT. If the combustion air blockage is easily accessible and removable, then remove it. If blockage is not obvious or cannot be removed, have the unit and system checked by a qualified service technician. If in doubt turn off your INSTINCT Boiler.
- Do not allow contaminated air to enter the unit's combustion air inlet. See *Page 5* for details.
- The INSTINCT is equipped with a low water cutoff device. The boiler and system piping must be filled and pressurized to 12 psig prior to startup. The unit will shut down if the pressure falls below 7.2 psig.
- Should overheating occur or if the gas supply fails to shut off, DO NOT turn OFF or disconnect the electrical supply to the pump. Instead, turn OFF the manual gas control valve external to the appliance.
- Combustion Readings - For your safety and to benefit from best warranty terms, ask your installer to provide combustion readings that are to be registered with Triangle Tube. See Warranty Card. Combustion readings should be checked at least annually for safe and reliable operation.

Boiler and System Water

- Have the boiler and system water chemistry checked at least annually by a qualified service technician.
- Do not use petroleum-based cleaning or sealing compounds in the boiler or system. Gaskets and seals in the system may be damaged, which can result in substantial property damage.
- Do not use any product not specifically designed for boiler / hydronic heating systems. Serious damage to the unit, piping system, personnel and / or property may result.
- Continual fresh makeup water will reduce the life of the INSTINCT. Addition of oxygen can cause internal corrosion in the system components. All leaks in the system must be repaired at once to prevent excessive makeup water.
- Do not add cold makeup water when the appliance is hot. Thermal shock can potentially cause cracks in the heat exchanger.
- Failure to comply with these instructions can result in substantial property damage, serious injury, or death.

CAUTION

- It is prohibited to carry out any modifications to the appliance without prior written consent from Triangle Tube.
- Faulty parts must only be replaced by genuine Triangle Tube factory parts.
- Failure to comply with these instructions can result in minor property damage, or injury.

NOTICE

- *The homeowner is only permitted to carry out the basic set-up operations (EZ Setup) after they have received all relevant instructions from the installer. Any other set-up must be carried out by a qualified installer.*
- *In case of any anomaly, please call your qualified service technician.*
- *Make sure to reference the unit's model number and serial number from the rating label when inquiring about service or troubleshooting.*
- *Triangle Tube reserves the right to change the technical characteristics, components and features of its products without prior notice. Check for an updated version of this manual at www.triangletube.com.*

INTENTIONALLY LEFT BLANK

WARNING

If the INSTINCT combustion air inlet is located in an area likely to cause or contain contamination, or if products which could contaminate the air cannot be removed, the combustion air must be repiped and terminated at another location. Contaminated combustion air will damage the unit and its burner system, and can result in substantial property damage, serious injury, or death.

DANGER

- Do not operate the INSTINCT if the combustion air inlet is located near a laundry room or pool facility. These areas will always contain hazardous contaminants.
- Pool, laundry, common household, and hobby products often contain fluorine or chlorine compounds. When these chemicals pass through the burner and vent system, they can form strong acids. These acids will corrode the heat exchanger, burner components, and vent system, causing serious damage and possible flue gas spillage or water leakage into the surrounding area.
- Please read the information listed below. If contaminating chemicals are located near the area of the combustion air inlet, the installer must pipe the combustion air inlet to an area free of these chemicals.
- Failure to comply with these instructions will result in substantial property damage, serious injury, or death.
- The INSTINCT boiler is classified as a Category IV appliance. This utilizes uncontaminated indoor or outdoor air for appliance combustion. A direct vent installation uses the outdoor air. Air supply, combustion chamber, heat exchanger and evacuation of POC (products of combustion) for this type of appliance is sealed with respect to the room in which the appliance is installed.
- An in-direct installation uses uncontaminated indoor air for appliance combustion.

- When the air for combustion is taken from the room an air grille must be installed by the contractor.

DANGER

- Ensure the vent grilles are free from obstruction at all times. Do not be tempted to restrict or cover the air grilles as it could cause serious injury, or death.

Potential contaminating products

- Spray cans containing chloro/fluorocarbons
- Permanent Wave Solutions
- Chlorinated wax
- Chlorine based swimming pool chemicals / cleaners
- Calcium Chloride used for thawing ice
- Sodium Chloride used for water softening
- Refrigerant leaks
- Paint or varnish removers
- Hydrochloric acid / muriatic acid
- Cements and glues
- Antistatic fabric softeners used in clothes dryers
- Chlorine-type bleaches, detergents, and cleaning solvents found in household laundry rooms
- Adhesives used to fasten building products and other similar products

Areas likely to contain these products

- Dry cleaning / laundry areas and establishments
- Beauty salons
- Metal fabrication shops
- Swimming pools and health spas
- Refrigeration Repair shops
- Photo processing plants
- Auto body shops
- Plastic manufacturing plants
- Furniture refinishing areas and establishments
- New building construction
- Remodeling areas
- Garages with workshops

INTENTIONALLY LEFT BLANK

CHAPTER 2 - MAINTENANCE SCHEDULES

2.1. Service Technician

At least on an **annual** basis the following maintenance should be performed by a qualified service technician:

General

- Attend to any reported problems.
- Inspect the interior of the boiler jacket area; clean and vacuum if necessary.
- Clean the condensate drain assembly and fill with fresh water.
- Check boiler fluid pH on systems.
- Check for leaks, both inside and outside the unit: water, gas, flue and condensate.
- Verify vent piping and air inlet piping are in good condition, sealed tight and properly supported.
- Check boiler water pressure, piping and expansion tank.
- Check control settings.
- Check ignition electrode (sand off any white oxide; clean and reposition).
- Check ignition wiring and ground wiring.
- Check all control wiring and connections.
- Check burner flame pattern (stable and uniform).
- Check carbon monoxide detectors.

Additional items if combustion or performance is poor:

- Clean heat exchanger and flue ways.
- Remove burner assembly and clean burner head using compressed air only.

Service Technician maintenance procedures can be found in Chapter 17 of the INSTINCT Installation and Maintenance manual.

Once the maintenance items are completed, review the service with the owner.

2.2. Owner Maintenance

Periodically:

- Check the area around the unit.
- Check and remove any blockage from the combustion air inlet and ventilation openings.
- Check the temperature and pressure gauges.
- Check CO detectors.

Monthly:

- Check vent piping.
- Check combustion air inlet piping or air grilles.
- Check the pressure relief valve.
- Check the condensate drain system.

Every 6 months:

- Check boiler piping and gas supply piping for corrosion or potential signs of leakage.
- Operate the pressure relief valve.



Follow the maintenance procedures given in Chapter 3 on page 5 of this manual. Failure to perform the service and maintenance or follow the directions in this manual can result in damage to the INSTINCT or system components, resulting in substantial property damage, serious injury, or death.

INTENTIONALLY LEFT BLANK

3.1. Owner Maintenance Procedures



The INSTINCT must be inspected and serviced annually, preferably at the start of the heating season, by a qualified service technician. In addition, the owner maintenance and care of the unit as outlined in *Chapter 2 on page 3* and further explained in this chapter should be performed to assure maximum safety, efficiency and reliability of the unit. Failure to service and maintain the INSTINCT and the system components can result in equipment failure, resulting in substantial property damage, serious injury, or death.



In the case of In-direct vent installation the air openings provided by the installer to supply ventilation and combustion air are essential for safe operation of the appliance. The user must respect the importance of these air openings and ensure that they are not partially or fully blocked under any condition. Failure to ensure free uncontaminated air flow through the openings can result in substantial property damage, serious injury, or death.

NOTICE

The following information provides detailed instructions for completing the owner maintenance items outlined in the maintenance schedule in Chapter 2 on page 3.

3.2. Daily Maintenance

3.2.1 Check Surrounding Area



Eliminate all the materials listed in *Chapter 1 on page 1* from the area surrounding the unit and from the vicinity of the combustion air inlet.

If contaminates are found:

- Remove products immediately from the area. If they have been there for an extended period, call a qualified service technician to inspect the unit for possible damage from corrosion.
- If products cannot be removed, immediately call a qualified service technician to re-pipe the combustion air inlet piping and locate the combustion air intake away from the contaminated areas.

Failure to comply with these instructions can result in substantial property damage, serious injury, or death

- Verify that the area surrounding the INSTINCT is free of combustible / flammable materials or flammable vapors or liquids. Remove immediately if found.
- Verify that combustion air inlet area is free of any contaminates. Refer to the materials listed in *Chapter 1 on page 1* of this manual. If any of these products are in the area from which the unit takes its combustion air, they must be removed immediately or the combustion air intake must be relocated to another area.



3.2.2 Check Ventilation Air Openings

Verify that all ventilation openings to the mechanical room or building are open and unobstructed.

Check and verify that the vent termination and the combustion air intake are free of debris and obstructions. Remove any debris on the air intake or flue exhaust openings. If removing the debris does not allow the unit to operate correctly, contact a qualified service technician to inspect the unit and the vent / combustion air system.

3.2.3 Check Temperature Display and Pressure Gauge

- Ensure the pressure reading on the pressure gauge does not exceed 25 psig. Higher pressure readings may indicate a problem with the expansion tank.
- Ensure the temperature on the display panel does not exceed 194°F. Higher temperature readings may indicate a water flow problem.
- Contact a qualified service technician if problem persists.



The annual service and inspection must ensure the venting and air supply are maintained in a correct and safe working condition. Damaged vent and air supply can result in serious injury, or death.



3.2.4 Check CO Detectors

Inspect all CO alarms, making sure that they are powered and functional. Follow the manufacturers maintenance and testing instructions for periodic alarm testing.

If any are not functional follow the manufacturers instruction for any remedial corrections. If these do not correct the issue contact a qualified service technician and replace the CO detectors as soon as possible.

3.3. Monthly Maintenance

3.3.1 Check Vent and Combustion Air Piping

- Visually inspect the venting system and combustion air piping for blockage, deterioration of gaskets or leakage. Contact a qualified service technician immediately if any problems are found.



In the case of In-direct vent installation the air openings provided by the installer to supply ventilation and combustion air are essential for safe operation of the appliance. The user must respect the importance of these air openings and ensure that they are not partially or fully blocked under any condition. Failure to ensure free uncontaminated air flow through the openings can result in substantial property damage, serious injury, or death.



Failure to inspect the vent system and combustion air inlet piping and to have any conditions repaired, will result in serious injury, or death.

3.3.2 Check Pressure Relief Valve

1. Visually inspect the pressure relief valve and the relief valve discharge pipe for signs of weeping or leakage.
2. If the pressure relief valve weeps often, the expansion tank may not be operating properly. Immediately contact a qualified service technician to inspect the unit and system.

CHAPTER 3 - MAINTENANCE PROCEDURES

3.3.3 Check Condensate Drain System

1. Ensure condensate drain assembly is firmly secured to bottom of the unit. See Fig. 1 on the right. Ensure the retention clip is secure. See Fig. 2 (Solo Models only).



WARNING

Do not operate the boiler without the factory-supplied condensate drain assembly installed. Operation of the boiler without the condensate drain assembly installed can result in property damage, serious injury, or death.

2. While the unit is running, check the discharge end of the condensate drain tubing. Ensure no flue gas is leaking from the condensate drain tubing by holding your fingers near the opening.
3. If you notice flue gas leaking, turn off the unit and contact a qualified service technician to inspect the unit and condensate drain assembly.
4. Ensure the condensate drain tubing is not blocked by pouring water through the fill plug port on the condensate drain assembly. The water should flow out of the end of the drain tubing. If water does not appear at the end of the drain tubing, contact a qualified service technician to inspect and clean the condensate drain assembly.
5. To fill the condensate drain assembly, remove the fill plug from the condensate assembly. Slowly pour water into the assembly until water appears at the end of the drain tubing. Stop filling and replace plug.

NOTE

To access the condensate siphon on the Floor Standing models remove the front panel. Gain access to the siphon by removing the securing screw holding the siphon cover plate.

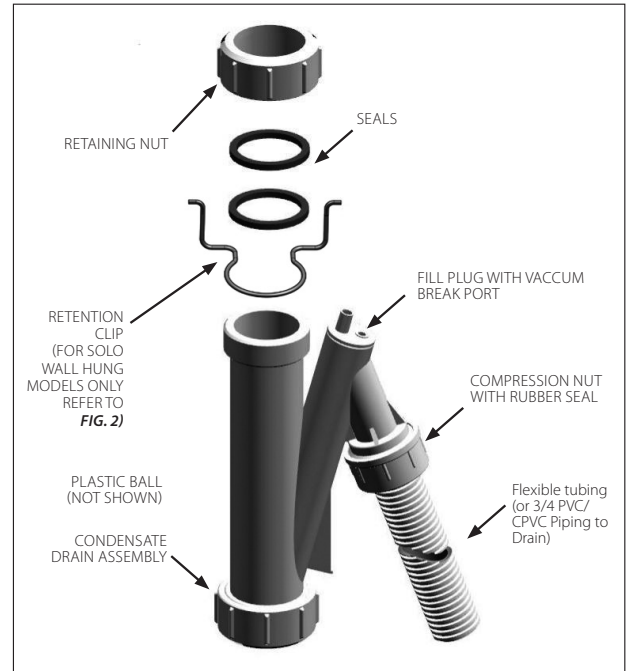

Fig. 1 - Condensate Drain Assembly

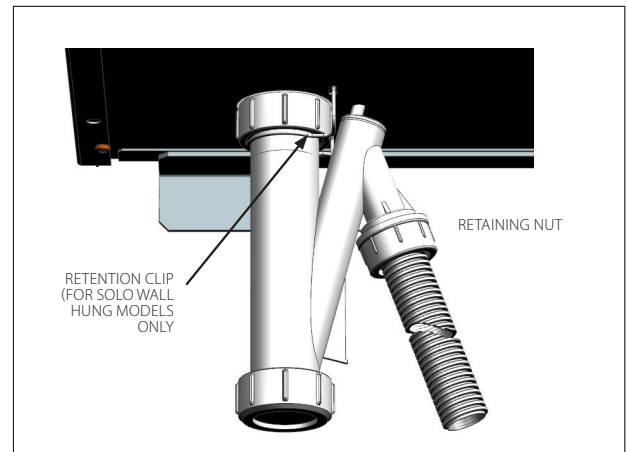

Fig. 2 - Condensate Retention Clip -
(Wall Hung Solo Models only)

3.4. 6-Month Maintenance

3.4.1 Check Water and Gas Piping

1. Remove the boiler front jacket panel and perform a gas leak inspection per steps 1 through 6 of the Operating Instructions on **page 9**. If gas odor or a leak is detected, immediately shut down the unit following procedures on **page 9**. Call a qualified service technician.
2. Visually inspect for leaks around the internal boiler water connections and around the heat exchanger. Visually inspect the external system piping, circulators, and system components and fittings. Immediately call a qualified service technician to repair any leaks.



Have leaks fixed at once by a qualified service technician. Failure to comply can result in substantial property damage, serious injury, or death.

3.4.2 Operate Pressure Relief Valve

1. Before proceeding, verify that the relief valve outlet has been piped to a safe place, avoiding any possibility of scalding from hot water.



To avoid water damage or scalding, a discharge line must be connected to the relief valve outlet and directed to a safe place of disposal. This discharge line must be installed by a qualified service technician in accordance with the INSTINCT installation manual. The discharge line must be terminated so as to eliminate possibility of severe burns or property damage should the valve discharge. Failure to comply can result in substantial property damage, serious injury, or death.

2. Read the pressure gauge to ensure the system is pressurized. Lift the relief valve top lever slightly, allowing water to relieve through the valve and discharge piping.

3. If water flows freely, release the lever and allow the valve to seat. Watch the end of the relief valve discharge pipe to ensure that the valve does not weep after the line has had time to drain. If the valve weeps, lift the lever again to clean the valve seat. If the valve does not properly seat and continues to weep afterwards, contact a qualified service technician to inspect the valve.
4. If water does not flow from the valve when you lift the lever completely, the valve or discharge line may be blocked. Immediately shut the unit down per the instructions on **page 9**. Call a qualified service technician to inspect the valve and discharge line.

FOR YOUR SAFETY READ BEFORE OPERATING



If you do not follow these instructions exactly, a fire or explosion may result, causing property damage, personal injury or loss of life.

- A. This appliance does not have a pilot. It is equipped with an ignition device which automatically lights the burner. Do not try to light the burner by hand.
- B. **BEFORE OPERATING**, smell all around the appliance area for gas. Be sure to smell next to the floor because some gas is heavier than air and will settle on the floor.
 - WHAT TO DO IF YOU SMELL GAS**
 - Do not try to light any appliance.
 - Do not touch any electric switch; do not use any phone in your building.
 - Immediately call your gas supplier from a neighbor’s phone. Follow the gas supplier’s instructions.
- **If you cannot reach your gas supplier, call the fire department.**
- C. Use only your hand to turn the external manual gas valve. Never use tools. If the valve will not turn by hand, don’t try to repair it; call a qualified service technician. Force or attempted repair may result in a fire or explosion.
- D. Do not use this appliance if any part has been under water. Immediately call a qualified service technician to inspect the appliance and to replace any part of the control system and any gas control which has been under water.

OPERATING INSTRUCTIONS

1. **STOP!** Read the safety information above. This appliance is equipped with an ignition device which automatically lights the burner. DO NOT try to light the burner by hand.
2. Set room thermostat(s) to lowest setting. Turn the external manual gas valve handle clockwise ↻ to “CLOSE” (valve handle must be perpendicular to gas piping).
3. Turn off all electrical power to the appliance.
4. Remove the front jacket panel on the unit.
5. Wait five (5) minutes to clear out any gas. If you then smell gas in the jacket enclosure or around the unit, **STOP!** Follow “B” in the safety information above. If you don’t smell gas, go to the next step.
6. Turn the external manual gas valve handle counter clockwise ↻ to “OPEN” gas supply (valve handle shall be parallel to gas piping).
7. Turn on all electrical power to the appliance.
8. Set room thermostat(s) to desired setting(s).
9. The appliance control panel display will show the current operating status on the Status Line at the bottom of the screen. “Standby” means there is no call for heat (all thermostats are satisfied). “CH Demand” indicates a space heating call has been received. “DHW Demand” indicates a domestic hot water call has been received. A flame icon will be displayed when the unit is fired.
10. If the unit will not operate, follow the instructions “To Turn Off Gas to Appliance” and call your service technician or gas supplier.
11. Replace the front jacket panel. Make sure the panel is seated firmly in place and all mounting screws are tightened.

TO TURN OFF GAS TO APPLIANCE

1. Set the room thermostat to lowest setting.
2. Turn off all electrical power to the appliance if service is to be performed.
3. Turn the external manual gas valve handle clockwise ↻ to “CLOSE” (valve handle must be perpendicular to gas piping).

INTENTIONALLY LEFT BLANK

CHAPTER 5 - CTRLMAX OPERATION

The CTRLMax Boiler Management System is designed to be flexible yet easy to use. CTRLMax monitors and controls the INSTINCT to provide heat as efficiently as possible.





All CTRLMax features are easy to use through a graphical display where information is presented either graphically or in plain English, so code charts are not required. Fig. 3 **below** shows an CTRLMax display example of the INSTINCT Solo fired for a domestic hot water demand.

5.1. CTRLMax Navigation

The CTRLMax navigation is performed through soft keys that react to the touch and emit a short beep when tapped.

NOTICE

Exert a light and short touch (tap) on the soft keys to activate their function. Holding the touch too long will not generate any reaction from the CTRLMax, unless it is a combination of soft keys meant to be touched simultaneously for a determined duration, as instructed in this manual. The arrow keys can also be held longer to increase or decrease values faster.

Navigation is performed through four arrow soft keys , , ,  with a center soft key  (OK/Reset functions) for making selections and entering information.



The Main Menu can be entered from the Home Screen by touching the center soft key .

To shut down the unit, touch the  soft key.

DANGER

When touching the  soft key, the unit shuts down but is not isolated from power supply. Therefore, live current is still present in the unit. For your safety, disconnect electrical power supply to the unit before servicing or making any electrical connections to avoid possible electric shock hazard. Failure to do so can cause serious injury, or death.

NOTICE

- *When shutting down using the  soft key, the appliance will not react to any heat demand. However, the basic appliance protection functions (such as frost protection, etc.) remain active.*
- *In addition, the arrow soft keys are no longer illuminated, and the  soft key lighting is dimmed.*

The menu system utilizes icons to represent each selection. The current selected menu is displayed as a reversed image with a text description shown at the top of the display. Menus can be entered by selecting the the desired icon (highlights) using the arrow soft keys.

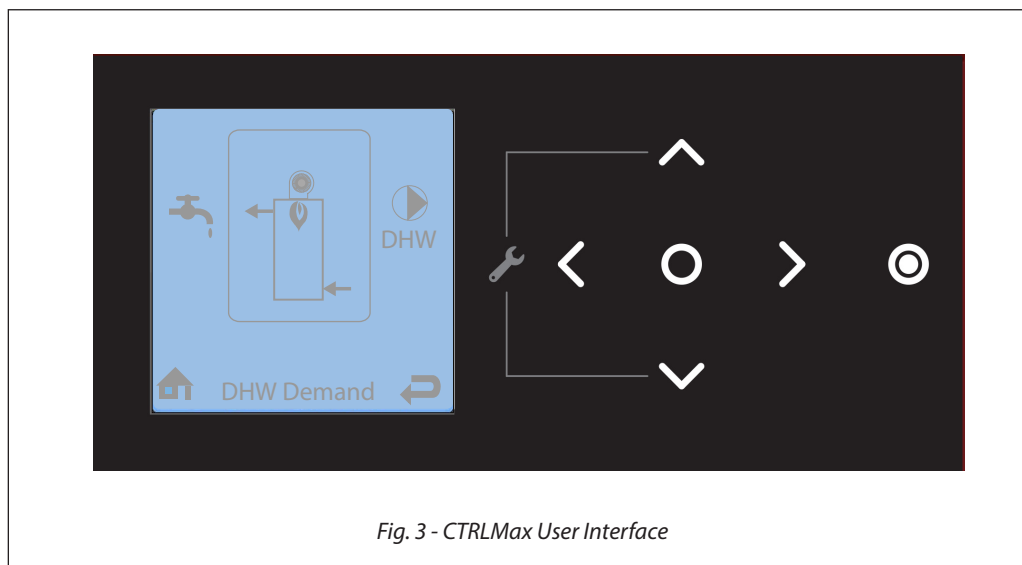
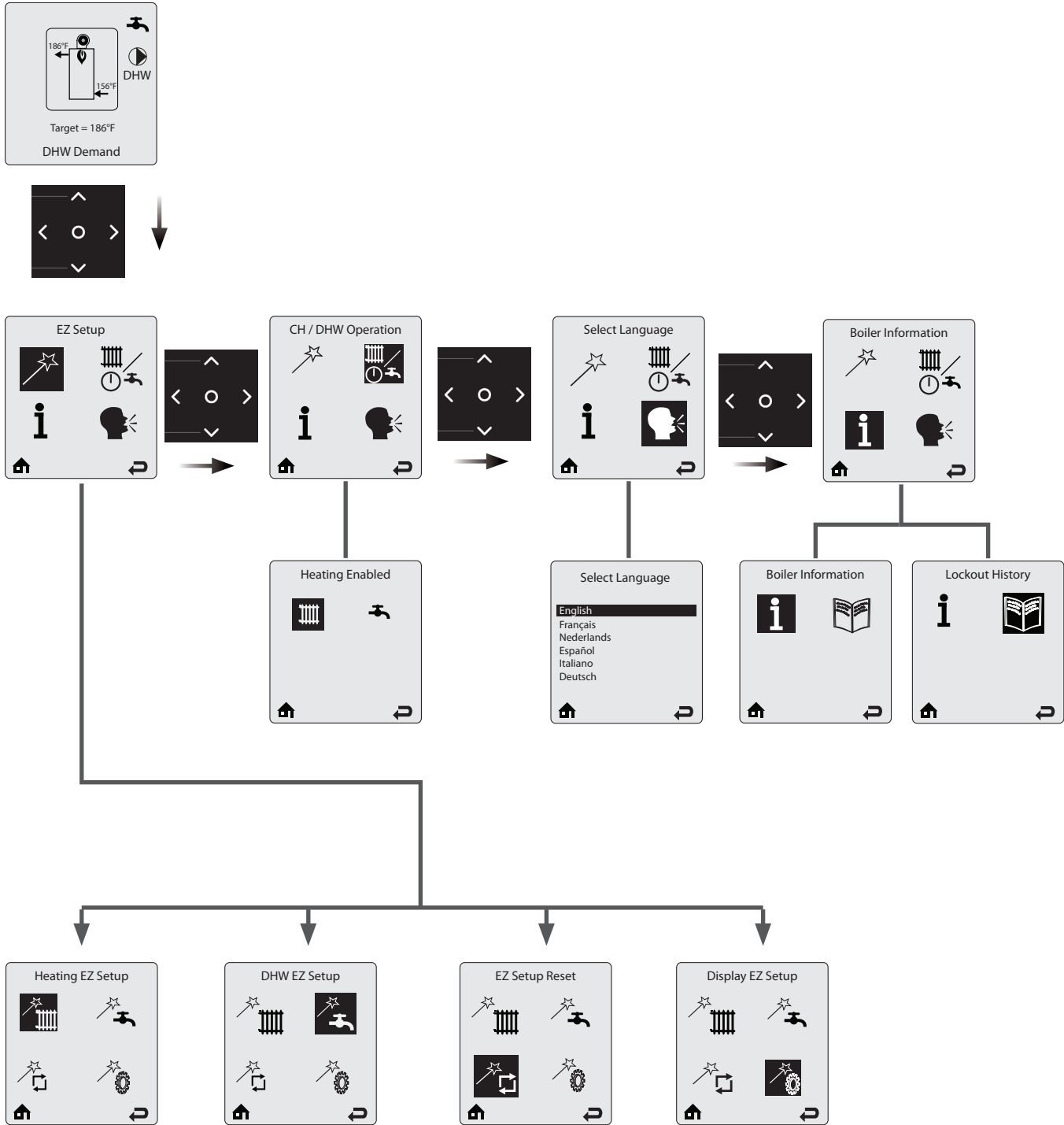

Fig. 3 - CTRLMax User Interface

CHAPTER 5 - CTRLMAX OPERATION

5.2. CTRLMax Menu Structure







CHAPTER 5











CHAPTER 5 - CTRLMAX OPERATION

5.3. Home Screen

The Home Screen presents status information in a very user friendly way so that the current state of the boiler can be quickly accessed.

- **Screen backlight** - it will illuminate when any soft key is touched, and remain illuminated for five minutes.
- **Screen brightness** - it can be adjusted at the Home screen by touching and holding simultaneously the  and  soft keys for 2 seconds. Touch the  and  soft key to increase or decrease the contrast. Touch  to end the process.

Main Icons of CTRLMax display



-  **Central Heating** - indicates information related to central/space heating.
-  **DHW** - indicates information related to Domestic Hot Water.
-  **Home** - to go back to the home screen.
-  **Back** - to go back to the previous screen.
-  **Warm Weather Shutdown** - displays on the home screen when the outdoor temperature reaches the Warm Weather Shutdown temperature.
-  **Reset** - to reset the system to the factory settings.
-  **Settings** - to access controller settings (language, units, etc.).
-  **Easy Setup** - to quickly adjust the most common settings.
-  **CH/DHW operation** - to enable/disable the central/space heating or Domestic Hot Water functions
-  **Information** - to get information on the boiler.

The model is indicated at the top of the screen.

The INSTINCT is represented in the center of the Home Screen. Basic operating information such as supply and return temperatures are displayed as well as current burner status.

Radiator icon: indicates that a central heating call has been received. A small number 1 or 2 indicates which CH calls are active

A flame symbol is displayed when the unit is fired. The flame size changes to indicate the current firing rate.

Basic information: The user can toggle through items using the  and  soft keys to view Target, Supply, Return, Domestic, Outdoor, System and Mix Zone temperatures, DHW flow.

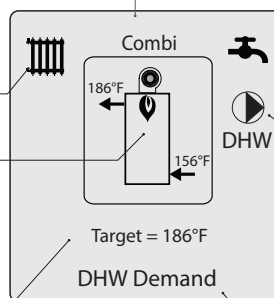

Faucet icon: indicates that a DHW call has been received.

Circulator icons: indicate which circulators are currently powered.

Status line: displays the current operating state of the boiler.

CHAPTER 5 - CTRLMAX OPERATION

5.4. Status Line Messages

Standby - Indicates that the INSTINCT is ready to respond when a demand is received.

CH Demand - A central heating call has been received.

DHW Demand - A domestic hot water call has been received.

CH/DHW Demand - Central heating and domestic hot water calls are being received simultaneously. Both calls are being satisfied simultaneously because domestic hot water priority has been disabled.

DHW Priority - Central heating and domestic hot water calls are being received simultaneously. Domestic hot water call is being satisfied first because it has priority over central heating calls.

Priority Timeout - Central heating and domestic hot water calls are being received simultaneously. The domestic hot water priority time limit has been exceeded. Priority will now switch back and forth between central heating and domestic hot water calls until one call is satisfied.

External Demand - An external modulation call has been received.

Slave Operation - The INSTINCT is a slave in a cascade system.

Manual Operation - The burner or circulators have manually been enabled in the Installer Menu.

CH Burner Delay - The burner will not fire until the call blocking time has elapsed.

DHW Burner Delay - The burner will not fire until the call blocking time has elapsed.

CH Setpoint Reached - The burner is not fired because the supply/system water temperature exceeds the setpoint. The central heating circulator(s) continue(s) to operate and the burner will fire again once the supply/system water temperature drops below the setpoint.

DHW Setpoint Reached - The burner is not fired because the supply/system water temperature exceeds the setpoint. The domestic circulator(s) continue(s) to operate and the burner will fire again once the supply/system water temperature drops below the setpoint.

CH Post Pump - The central heating circulator(s) is/are running to remove heat from the INSTINCT at the completion of a call.

DHW Post Pump - The domestic hot water circulator(s) is/are running to remove heat from the INSTINCT at the completion of a call.

Freeze Protection - The burner is fired because the freeze protection feature has been activated. Freeze protection will end once the supply/system water temperature is raised to 60°F [16°C].

Boiler Protection - The burner firing rate is being reduced because of an excessive difference between the boiler supply and return temperatures. The firing rate will begin increasing once the temperature difference is less than 45°F [25°C].

Low Water Pressure - The system pressure has dropped to 10.1 psi. The INSTINCT will still respond to calls until the pressure drops below 7.2 psi. Increase system pressure to 14.5 psi to clear Low Water Pressure warning

Lockout Description - The lockout which currently has the INSTINCT shut down is displayed.

CHAPTER 5 - CTRLMAX OPERATION

5.5. Main Menu

The Main Menu can be entered from the Home Screen by touching the  soft key.

The menu system utilizes icons to represent each selection.

The currently selected menu is displayed as an inverted image with a text description shown at the top of the display.

Menus can be entered by scrolling through the icons using the arrow soft keys, highlighting the desired icon and touching the  soft key.

5.6. EZ Setup

The EZ Setup menu provides a simple way to quickly customize CTRLMax for each installation. EZ Setup prompts the user to make selections which allows the INSTINCT to be setup very quickly without searching through long lists of settings and manually making adjustments.

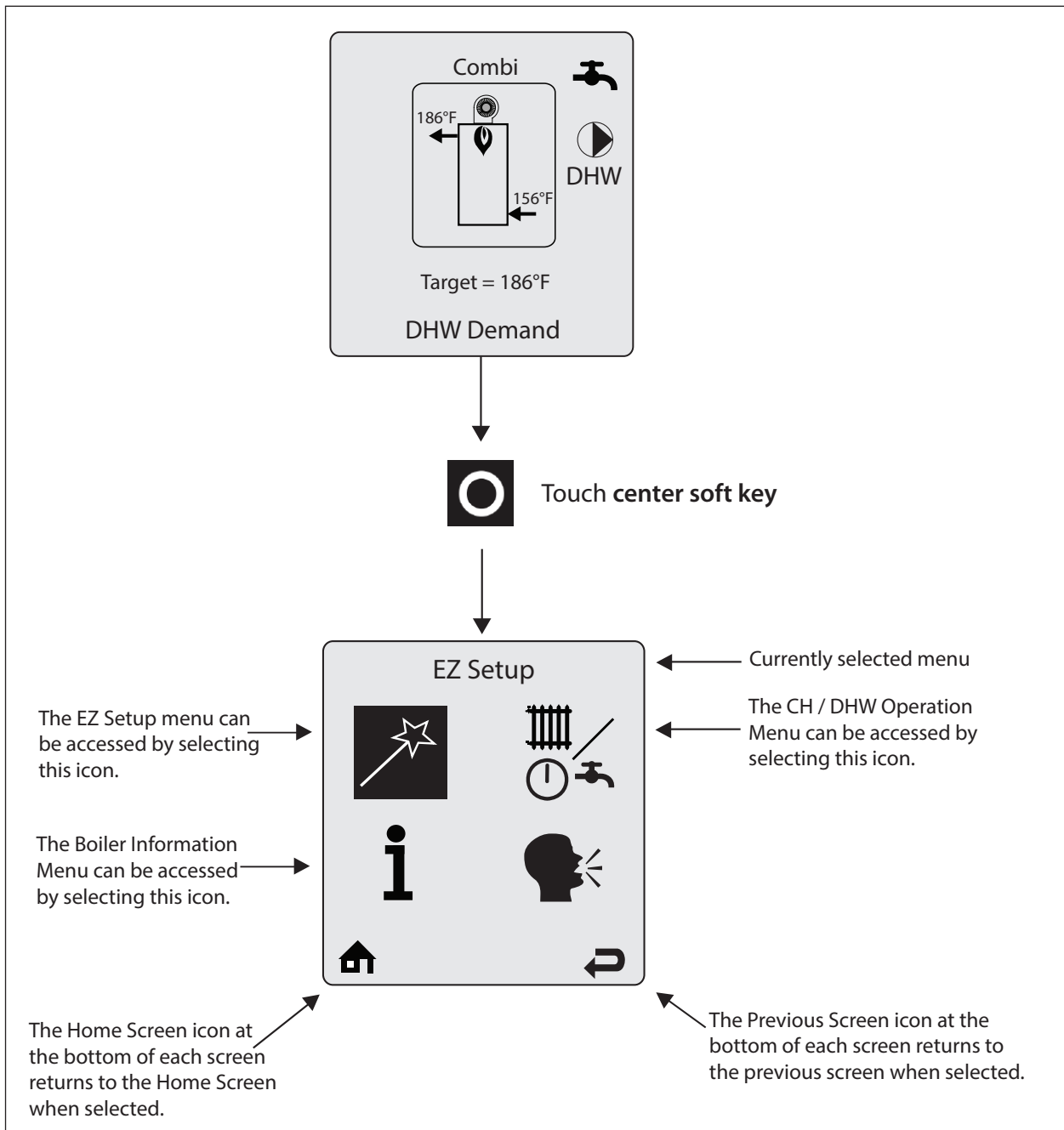

5.7. CH / DHW Operation

The CH / DHW Operation Menu can be entered from the Main Menu by selecting the CH / DHW Operation icon and touching the  soft key. The CH / DHW Operation Menu provides a simple way to disable either the central heating or domestic hot water functions of the INSTINCT.

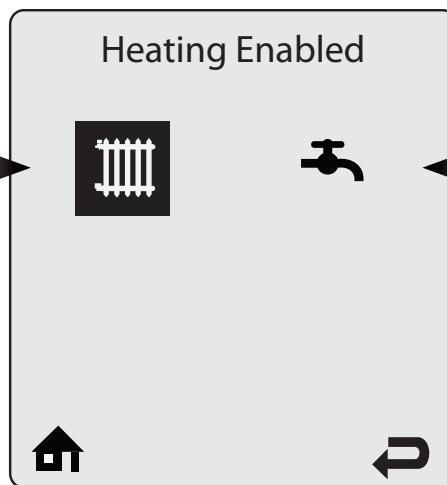
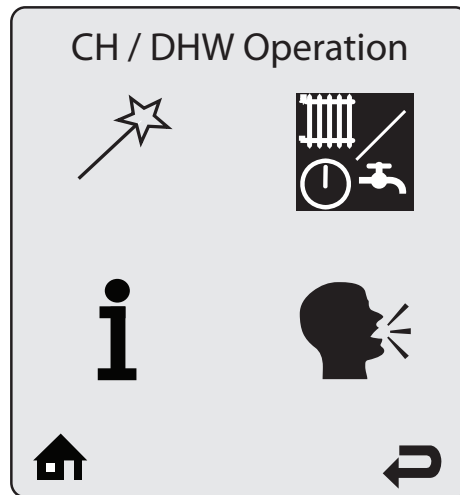

Heating Operation can be enabled and disabled by selecting the radiator icon and touching the  soft key to toggle operation between enabled and disabled.

A radiator icon with an X through it indicates that the heating function is disabled.

This icon is also displayed on the Home Screen when disabled.

Domestic Hot Water Operation can be enabled and disabled by selecting the faucet icon and touching the  soft key to toggle operation between enabled and disabled.

A faucet icon with an X through it indicates that the domestic hot water function is disabled.

This icon is also displayed on the Home Screen when disabled.

5.8. Language Selection

The Select Language Menu can be entered from the Main Menu by selecting the Select Language icon and touching the  soft key. The Select Language Menu provides a simple way to select the language used on the display (nine different languages: English, French, Dutch, Spanish, Italian, German, Czech, Polish and Russian).

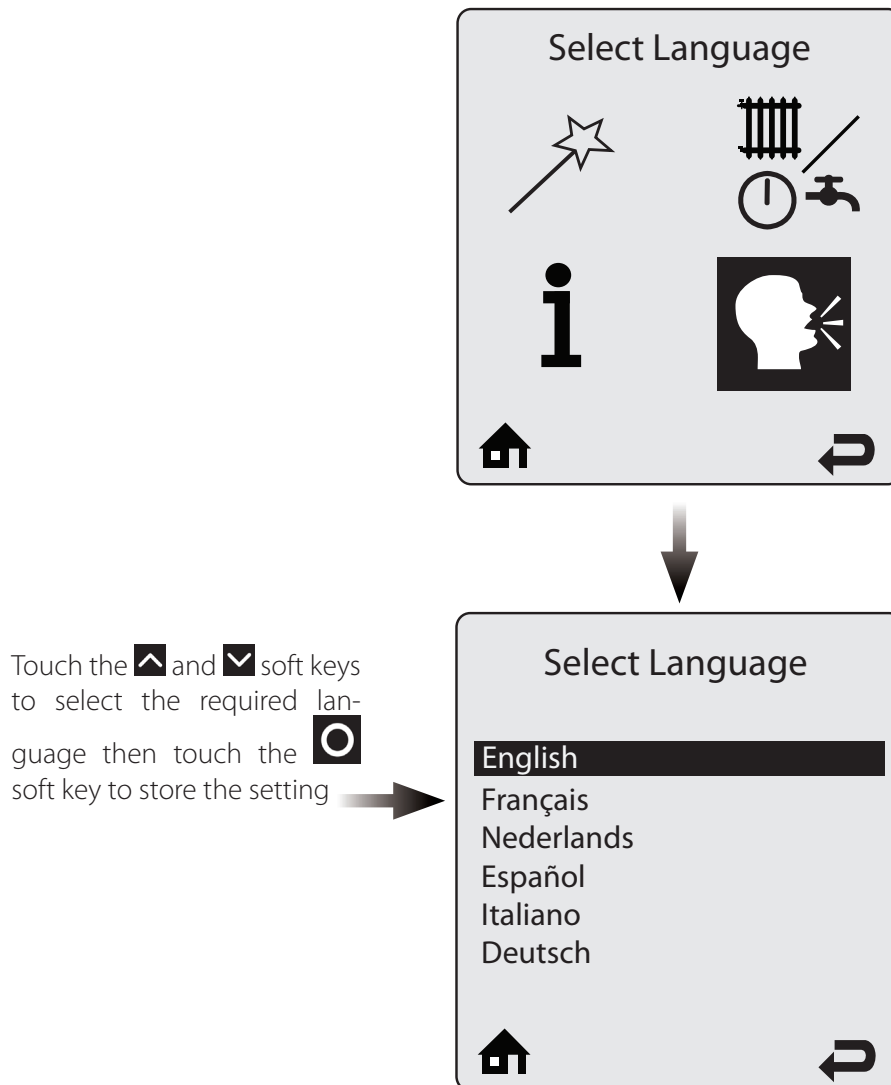

5.9. Boiler Information

Boiler Information can be viewed by selecting the Boiler Information icon and pressing the **OK** button. Boiler Information provides real time operating information of the INSTINCT.

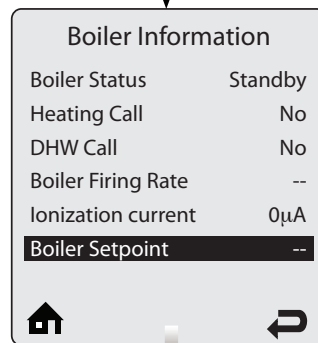
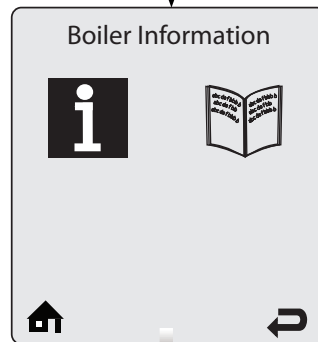
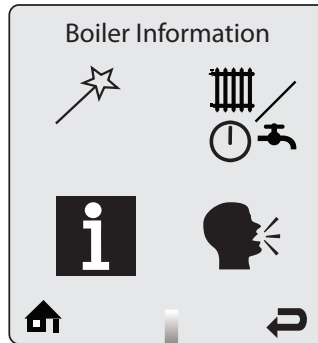

Boiler Information displays six boiler readings at a time. Each line contains an information item followed by its current value. Touch the and soft key to scroll through additional information items.

Some information items include a logging function.

Select the information item then touch the soft key to view its graph.

One sample is recorded every 12 minutes to produce a graph of the last 24 hours.

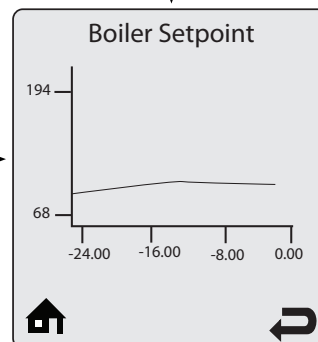

The following items have a logging function:

- Boiler Firing Rate
- Ionization Current
- Boiler Setpoint
- Boiler Supply Temperature
- Boiler Return Temperature
- Boiler Flue Temperature
- Outdoor Temperature
- DHW Storage Temperature
- External Modulation Signal
- Pressure

CHAPTER 5 - CTRLMAX OPERATION

5.9.1 Information Items

Information Item	Description
Boiler Status	Displays the current operating state of the INSTINCT. This is the same as the status line on the home screen.
Heating Call	Displays if a central heating call is present.
DHW Call	Displays if a domestic hot water call is present.
Boiler Firing Rate	Displays the current firing rate of the INSTINCT.
Ionization Current	Displays the current flame ionization current from the ignitor.
Boiler Setpoint	Displays the current setpoint of the INSTINCT.
Supply Temp.	Displays the current supply temperature of the INSTINCT.
Return Temp.	Displays the current return temperature to the INSTINCT.
Boiler Flue Temp.	Displays the current flue temperature of the INSTINCT.
Outdoor Temp.	Displays the current outdoor temperature.
DHW Storage Temp.	Displays the current DHW storage temperature when Indirect Water Heater Sensor PSRKIT22 is installed.
External Modulation Signal	Displays the current external modulation signal being received from an external controller.
Pressure	Displays the current system water pressure.
CH Ignitions	Displays the number of central heating ignitions since the unit was installed. This counter increases in increments of twenty.
CH Runtime	Displays the number of hours the INSTINCT has run for a central heating call since the unit was installed.
DHW Ignitions	Displays the number of domestic hot water ignitions since the unit was installed. This counter increases in increments of twenty.
DHW Flowrate	Displays the Domestic Hot Water flow rate
DHW Runtime	Displays the number of hours the INSTINCT has run for a domestic hot water call since the unit was installed.
Mix Zone Temperature	Displays the current low temperature mix zone temperature.

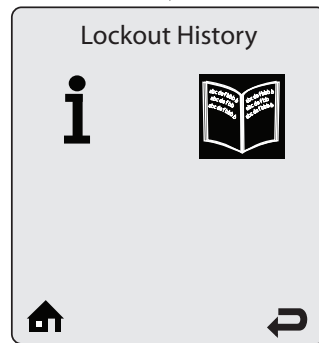
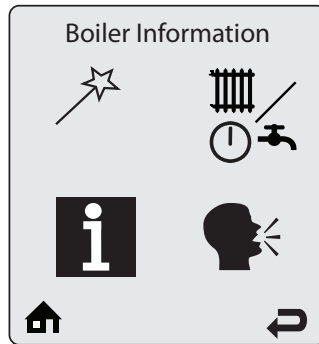

5.10. Lockout History

Lockout History can be viewed by selecting the Lockout History icon and pressing the **OK** button. The Lockout History Screen lists the last eight lockouts along with how long ago they occurred.



Lockout History displays the last eight lockouts. The newest lockout is displayed at the top of the screen.

The lockout message is followed by how long ago the error occurred.

Touch the  and  soft keys to scroll through additional lockouts.

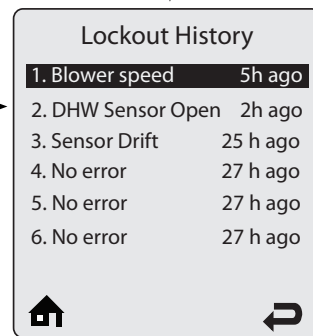

Lockout Details displays the lockout at the top of the screen followed by a snapshot of the boiler information recorded at the time of the lockout.

Touch the  and  soft keys to scroll through additional information items.

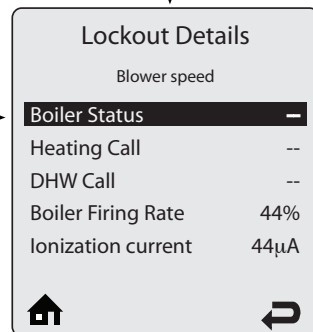

CHAPTER 5 - CTRLMAX OPERATION

5.10.1 Lockout Screen

If a problem occurs, the Lockout Screen replaces the Home Screen. The backlight will remain on until the lockout is reset.

Pressing any arrow button will return to the Home Screen so that additional troubleshooting can be performed. See *Sections 5.10.2 on page 22 and 5.10.3 on page 23* for a list of lockouts and descriptions.

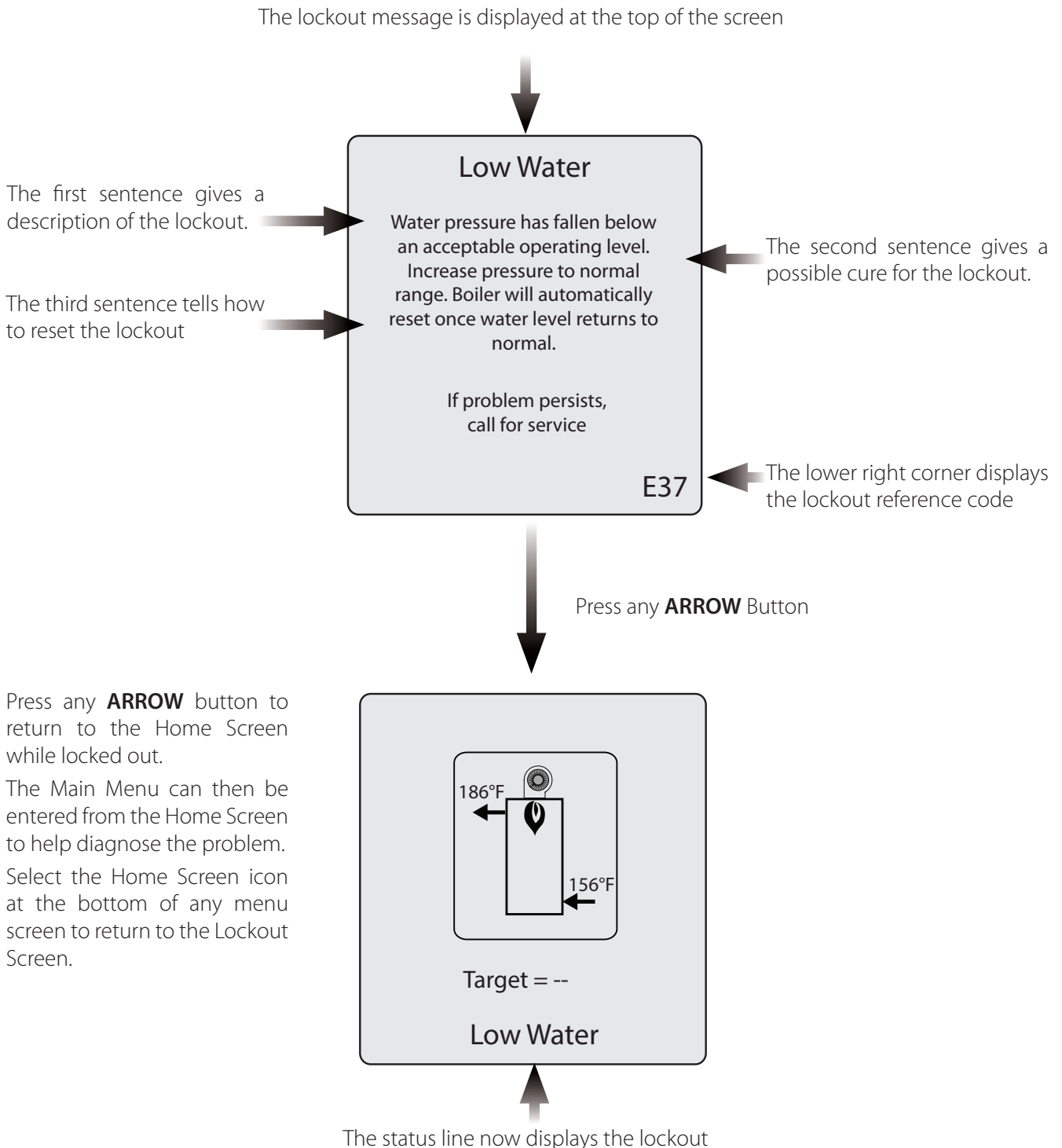

CHAPTER 5 - CTRLMAX OPERATION

5.10.2 Manual Reset Lockouts

Code	Lockout Message	Description
E1	Failed Ignition	The burner failed to light after 5 ignition attempts.
E2	False Flame	Flame detected prior to ignition.
E3	High Boiler Temperature	Boiler temperature has reached 210°F [99°C] or 102°F [39°C].
E5	Blower Speed	Blower is not at correct speed or speed signal is not being received by control module.
E8	Flame Circuit Error	Flame circuit test failed.
E9	Gas Valve Circuit Error	Gas valve circuit test failed.
E13	Reset Limit Reached	Resets are limited to 5 every 15 minutes.
E15	Sensor Drift	Supply or return sensor reading has drifted.
E16	Supply Sensor Stuck	Supply sensor reading is not changing.
E17	Return Sensor Stuck	Return sensor reading is not changing.
E18	Sensor Failure	Supply or return sensor reading changed very rapidly.
E19	Flame Failure During Startup Phase	Flame lost after startup
E21	Internal Control Fault	A / D conversion error.
E30	Supply Sensor Shorted	A short circuit has been detected in the boiler supply temperature sensor circuit.
E31	Supply Sensor Open	An open circuit has been detected in the boiler supply temperature sensor circuit.
E43	Return Sensor Shorted	A short circuit has been detected in the boiler return temperature sensor circuit.
E44	Return Sensor Open	An open circuit has been detected in the boiler return temperature sensor circuit.
E47	Water Pressure Sensor Error	Water pressure sensor is disconnected or broken.
E80	Return > Supply	Return temperature is higher than supply temperature.
E83	Delta T Protection	Excessive difference between boiler supply and return temperatures has occurred 5 times
E87	External Limit Open	An external manual reset limit has opened

CHAPTER 5 - CTRLMAX OPERATION

5.10.3 Automatic Reset Blocking Lockouts

Code	Lockout Message	Description
E7	High Flue Temperature	Flue temperature exceeds high limit.
E12	Internal Control Fault	EEPROM misconfiguration.
E25	Internal Control Fault	CRC check error.
E32	DHW Sensor Shorted	A short circuit has been detected in the DHW temperature sensor circuit.
E33	DHW Sensor Open	An open circuit has been detected in the DHW temperature sensor circuit.
E34	Low Voltage	Line voltage has fallen below an acceptable operating level.
E37	Low Water	Water pressure has fallen below 7.2 psi.
E45	Flue Sensor Shorted	A short circuit has been detected in the boiler flue temperature sensor circuit.
E46	Flue Sensor Open	An open circuit has been detected in the boiler flue temperature sensor circuit.
E76	External Limit Open	An external automatic reset boiler limit has opened.
E77	High Mix Circuit Temperature	Mix circuit temperature exceeds Mix zone high limit setting.
E78	Mix Circuit Sensor Shorted	A short circuit has been detected in the mix circuit temperature sensor circuit.
E79	Mix Circuit Sensor Open	An open circuit has been detected in the mix circuit temperature sensor circuit.
E81	Sensor Drift	Supply and return temperatures are not equal.
E82	Delta T Protection	Excessive difference between the boiler supply and return temperatures.
E89	Incorrect Setting	A parameter setting is in conflict with another setting.
E90	Firmware Mismatch	Control module and display firmware versions are incompatible.
E91	System Sensor Shorted	A short circuit has been detected in the system temperature sensor circuit.
E92	System Sensor Open	An open circuit has been detected in the system temperature sensor circuit.
E93	Outdoor Sensor Shorted	A short circuit has been detected in the outdoor temperature sensor circuit.
E94	Internal Display Fault	Display memory error.
E95	Supply Sensor Error	Supply sensor reading is invalid.
E96	Outdoor Sensor Open	An open circuit has been detected in the outdoor temperature sensor circuit.
E97	Cascade Mismatch	Cascade configuration has changed.
E98	Cascade Bus Error	Communication with other boilers has been lost.
E99	Controller Bus Error	Communication between boiler display and control module has been lost.

Additional quality water heating equipment available from Triangle Tube

Maxi-Flo Pool and Spa Heat Exchangers



- Constructed of high quality corrosion resistant stainless steel (AISI 316) or titanium
- Specially designed built-in flow restrictor to assure maximum heat exchange
- Compact and light weight
- Available in 8 sizes to accommodate any size pool or spa

SMART 316 Indirect Fired Water Heaters



- Exclusive Tank-in-Tank design
- Stainless steel construction
- Available in 7 sizes
- Limited LIFETIME residential warranty
- 6 Year limited commercial warranty
- Self cleaning/self descaling design

TTP Brazed Plate Heat Exchangers

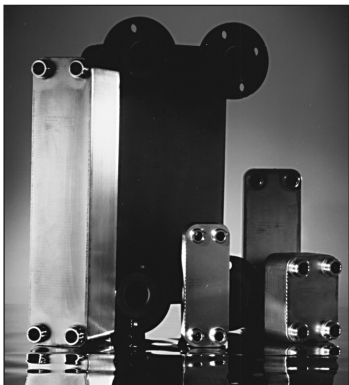

- For domestic water, snow melting, radiant floor
- Plates made of stainless steel, with 99.9 % copper brazing, ensuring a high resistance to corrosion
- Self cleaning and self descaling
- Computerized sizing available from Triangle Tube
- Available in capacities from 25,000 BTU/hr to 5,000,000 BTU/hr



Triangle Tube - 1240 Forest Parkway, Suite 100, West Deptford NJ 08066

Tel: (856) 228 8881 - Fax: (856) 228 3584 - E-mail: info@triangletube.com