



Marquis User's Manual

Model

TWH200 / TWH200LP
Gas Condensing Water Heater

- Natural Gas(NG) – TWH200
- Liquid Propane Gas (LP) – TWH200LP



WARNING

Read the Installation Manual carefully and be sure that your water heater has been properly assembled, installed and maintained. Failure to follow these instructions exactly could result in a fire or explosion, serious bodily injury and/or property damage.

Installation and service must be performed by a qualified plumber, a licensed gas fitter, or a professional technician in accordance with all local codes.

Improper installation and/or operation by an unqualified person will void the warranty.

If the information in these instructions is not followed exactly, a fire or explosion may result, causing property damage, personal injury, or death.

- Do not store or use gasoline or other flammable vapors and liquids in the vicinity of this or any other appliance.
- **WHAT TO DO IF YOU SMELL GAS**
 - Do not try to light any appliance.
 - Do not touch any electrical switch; do not use any phone in your building.
 - Immediately call your gas supplier from a neighbor's phone. Follow the gas supplier's instructions.
 - If you cannot reach your gas supplier, call the fire department.
- Installation and service must be performed by a qualified installer, service agency or the gas supplier.

Table of Contents

Product and Safety Information

Marquis Operation	1
Definitions	1
Operating Instructions	2-4

Method of Operation

Before Operation	5
Operation	5
Display Panel	6
LCD Display	7
Operating Mode	8
DHW Setpoint Change Modes	9
Error Mode	10
Information Mode	11
Installer Mode	12

Maintenance

Regular Maintenance	13
Maintenance Procedures	13-15

Troubleshooting

Troubleshooting	16
Diagnostics	17-18

Error Codes

Error Codes	19-21
Control Logic	22-24

Product & Safety Information

Marquis Operation

Cold water is heated by the burner as it passes through the stainless steel heat exchanger. The burner firing rate constantly adjusts to maintain the DHW setpoint temperature.

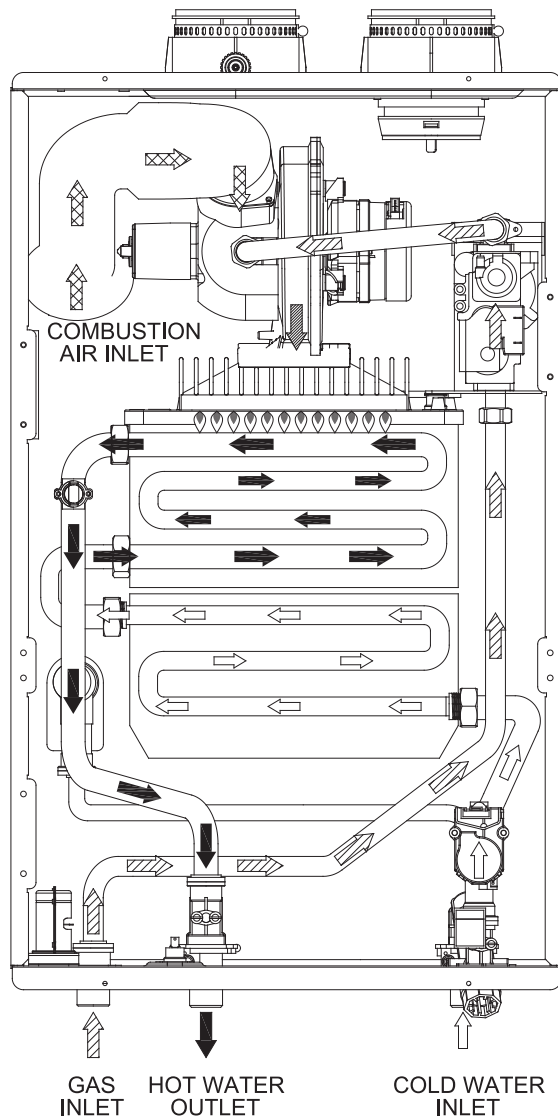

⚠ WARNING

To avoid product damage, personal injury, or even possible death, carefully read, understand, and follow all the instructions in the Marquis Installation manual before installation, operation, or service.

ACV-Triangle Tube cannot anticipate every circumstance that might involve a potential hazard. Therefore, all possible incidents are not included in our warnings. Proper installation, operation, and service are your responsibility.

You must be satisfied that the operation and settings of the Water Heater are safe for you and for others.

Definitions

Safety Symbols are provided in the manual. When a user fails to adhere to the following requirements, it may cause death, serious damage, or great property loss.

⚠ DANGER

Indicates an imminently hazardous situation which, if not avoided, will result in death or serious injury.

⚠ WARNING

Indicates a potentially hazardous situation which, if not avoided, could result in death or serious injury.

⚠ CAUTION

Indicates a potentially hazardous situation which, if not avoided, may result in minor or moderate injury. It is also used to alert against unsafe practices and hazards involving only property damage.

⚠ WARNING

**FOR YOUR SAFETY READ
BEFORE OPERATING**

If you do not follow these instructions exactly, a fire or explosion could result causing property damage, personal injury or loss of life.

A. This appliance does not have a pilot. It is equipped with an ignition device which automatically lights the burner. Do not try to light the burner by hand.

B. BEFORE OPERATING smell all around the appliance area for gas. Be sure to smell next to the floor because some gas is heavier than air and will settle on the floor.

WHAT TO DO IF YOU SMELL GAS

- Do not try to light any appliance.
- Do not touch any electric switch; do not use any phone in your building.
- Immediately call your gas supplier from a neighbor's phone. Follow the gas supplier's instructions.
- If you cannot reach your gas supplier, call the fire department.

C. Use only your hand to push in or turn the gas control knob. Never use tools. If the knob will not push in or turn by hand, don't try to repair it, call a qualified service technician. Force or attempted repair may result in a fire or explosion.

D. Do not use this appliance if any part has been under water. Immediately call a qualified service technician to inspect the appliance and to replace any part of the control system and any gas control which has been under water.

This appliance must be installed in accordance with local codes if any; if not, follow ANSI Z223.1/NFPA 54 or CAN/CSA B149.1, Natural Gas and Propane Installation Code, as applicable.

OPERATING INSTRUCTIONS

1. STOP! Read the safety information above on this label.
2. Set the thermostat to lowest setting.
(Do not use Water Heater unless it is completely filled with water.)
3. Turn OFF electrical power supply to the Water Heater.
4. This Water Heater is equipped with an ignition device which automatically lights the main burner. Do not try to light the burner by hand.
5. Turn gas shut-off valve clockwise to "OFF" position. Do not force
6. Wait five (5) minutes to clear out any gas. If you then smell gas, STOP! Follow step "B" above on this label. If you don't smell gas, go to next step.
7. Turn manual gas shut-off valve to "ON" position.
8. Turn ON electrical power to the appliance.
9. Wait until default temperature (120°F) is displayed. Set desired water temperature. Turn hot water faucet on.
10. Set thermostat to desired setting.
11. If the appliance will not operate, follow the instructions "To Turn Off Gas To Appliance" and call your service technician or gas supplier.

NOTE : AUTOMATIC GAS SHUT OFF VALVE IS RESET BY TURNING WATER FLOW "OFF" THEN "ON" AGAIN.

⚠ WARNING

TO TURN OFF GAS TO APPLIANCE

1. Set the thermostat to lowest setting.
2. Turn off all electric power to the appliance if service is to be performed.
3. Turn manual gas shutoff valve to "OFF" position

Product & Safety Information

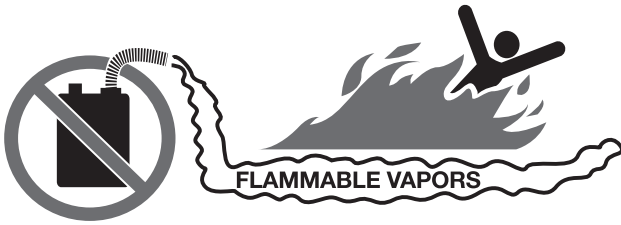

⚠ DANGER

- Vapors from flammable liquids can explode and catch fire causing death or severe burns.

Do not use or store flammable products such as gasoline, solvents or adhesives in the same room or area near the appliance.

Keep flammable products

- Far away from Water Heater
- In approved containers
- Tightly closed
- Out of children's reach

Vapors

- Cannot be seen
- Are heavier than air
- Spread on the floor
- Can spread from other rooms to the main burner by air currents

Do not install the appliance where flammable products will be stored.

Read and follow Water Heater warnings and instructions. If owner's manual is missing contact the retailer or manufacturer.

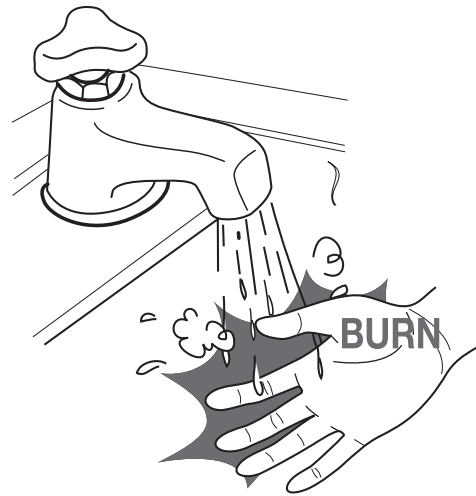

⚠ DANGER

Use this Water Heater at your own risk. The outlet temperature of the Marquis Water Heater is factory preset to 120°F (49°C). The temperature can only be changed by using the control panel.

Hot water temperature over 125°F (52°C) can cause severe burns instantly or death from scalding. Children, disabled, and elderly are at the highest risk of being scalded. Do not leave children or the infirm unsupervised. Check temperature of hot water before taking a shower or bath. To control water temperature to a particular faucet, temperature limiting valves can be installed by your service professional.

Product & Safety Information

WARNING

- The Marquis Water Heater must be installed by a qualified plumber, a licensed gas fitter, or a professional service technician. Improper installation or operation can cause serious injury or death. It also voids the warranty.
 - The National Fuel Gas Code NFPA 54 / ANSI Z223.1
 - National Electric Code ANSI/NEPA 70
 - All applicable local, state, national and provincial codes, regulations, and laws.
- Proper care is your responsibility. Carefully read and understand the Operating Information in this manual before operating the Marquis Water Heater.
- Be aware of the location of the gas shut-off valve and operation method.

Close the gas shut-off valve immediately if the appliance is subjected to fire, overheating, flood, physical damage, or any other damaging condition that might affect the operation of the unit.

The Water Heater must be checked by a qualified technician before resuming operation.
- DO NOT use this Water Heater if any part has been submerged under water. Call a qualified technician immediately for inspecting the Water Heater and for replacing any part of the control system and any gas control which has been under water.
- Do not power up the unit unless the gas and water supply valves are fully opened. Make sure that fresh air intake port and exhaust gas port are opened and functional.

- DO NOT attempt to install, repair, or service the Water Heater by yourself. Contact a qualified technician if the Water Heater needs repair or maintenance.
- DO NOT use spray paint, hair spray, or any other flammable spray near the Water Heater or the exterior fresh air inlet port. DO NOT place any items in or around the exterior exhaust gas outlet port and/or fresh air inlet port. It could restrict or block the flow in or out of the vent system.
- After installing the water heater, safety device must be tested.

CAUTION

While repairing controls, all wires are labeled. Also, they must be connected in accordance with the instructions.

Wiring errors can cause improper and dangerous operation.

- Verify proper operation after servicing.
- The gas ignition system components must be protected from water (dripping, spraying, rain, etc.) during appliance operation and service (circulator replacement, condensate trap, control replacement, etc.).

Method of Operation

Before Operation

1. Check the Gas Type (NG/LP)

When using the unit for the first time, check if gas type matches with the gas type of the Water Heater. (Check whether the gas type which is supplied is NG or LP and also check the Water Heater gas type.) The gas type is indicated on the rating plate on side of the Water Heater.

2. Check the Power (120V 60Hz)

Check whether the appliance is connected properly.

3. Check the Cold Water Inlet valve

Open the appliance water inlet valve. The appliance will not ignite when insufficient water or no water is present at the cold water inlet.

4. Check the Gas valve

Check if the manual gas shut-off valve to the appliance is opened.

5. Check the Area Around the Appliance

Remove any combustible or flammable materials and do not place any wet laundry on the exhaust vent.

Operation

1. Check for Gas leak

Check for gas leak at the gas connection with soapy water.

2. Check Ventilation

Make sure that there is sufficient inflow and outflow of ventilation air while using the unit. If the ventilation is improper, then the combustion condition deteriorates inside the appliance and it may cause shortened life of the appliance.

3. Burn Warning

Be careful not to burn yourself by the flue or pipes. They are getting extremely hot during operation.

4. Combustibles Warning

Do not use the appliance for any other purpose than for heating hot water. Do not store combustibles or flammable material such as gasoline near the appliance.

Method of Operation

■ Display panel

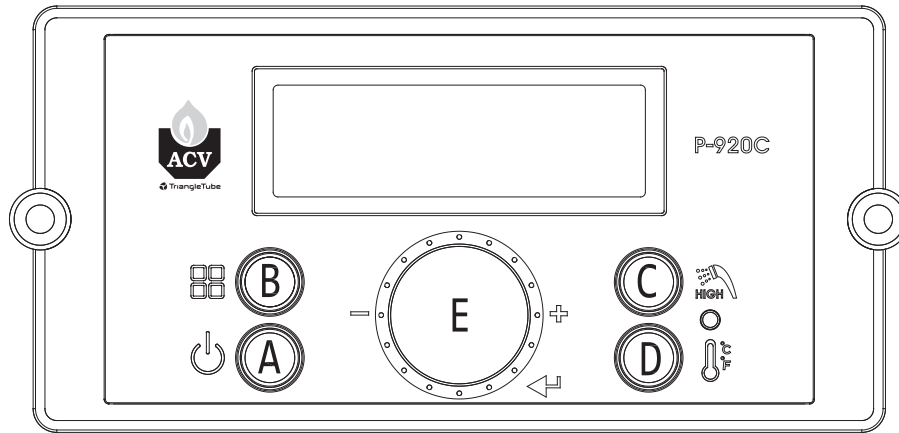

Buttons	Functionality	
	Push (under 5 seconds)	Hold (more than 5 seconds)
A	ON/OFF	N/A
B	N/A	Information mode with power ON. Installer mode with power OFF.
C	Adjust set point (95°-125°)	Adjust set point (125°-140°)
D	N/A	Change temperature unit (°C / °F)
E	Menu Scroll & Setting Adjustments	N/A

Method of Operation

■ LCD Display

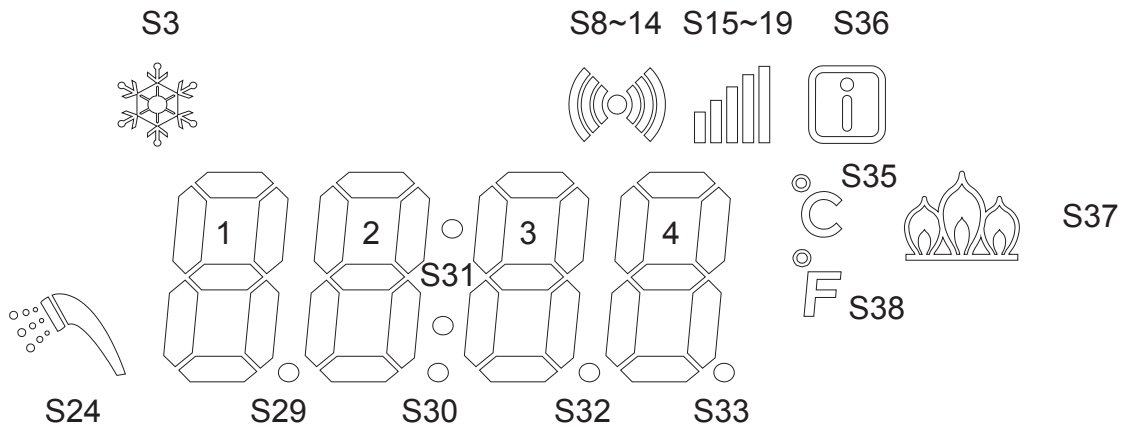

Segment	Name	Description
S3	Anti-freeze mode	Anti-Freeze mode indicated
S8,S11,S14	Lock mode	Lock mode indication
S15 ~ S19	Communication state	Communication state indication
S24	DHW mode	Water heater operating indication
S29 ~ S33	Dot, colon	Separate indication
S35	Celsius mode	Celsius temperature reading
S36	Installer mode	Unused
S37	Flame signal	Flame Signal indication
S38	Fahrenheit mode	Fahrenheit temperature reading
1A ~ 4G	8 segment	Number and character indication

LCD has a backlight that will illuminate:

- When a user action has been detected (a button is pressed)
- The timeout is approximately 20 seconds.

Method of Operation

■ Operating Mode

After power on, the display shows a sequence of information during start-up. The following indications will appear:

Indicate on digits	Show Time	Examples
LCD test: All segments ON	1 seconds	
LCD test: All segments OFF	0.5 seconds	
Text "Pdn"	1 seconds	
Show product number of control family	1 seconds	Number "16"
Text "SFn"	1 seconds	
Show software version of control family	1 seconds	Number "1.01"
Text "Hdn"	1 seconds	
Show Hardware version of control family	1 seconds	Number "0001"

After start-up, the standby mode will be displayed as shown below.

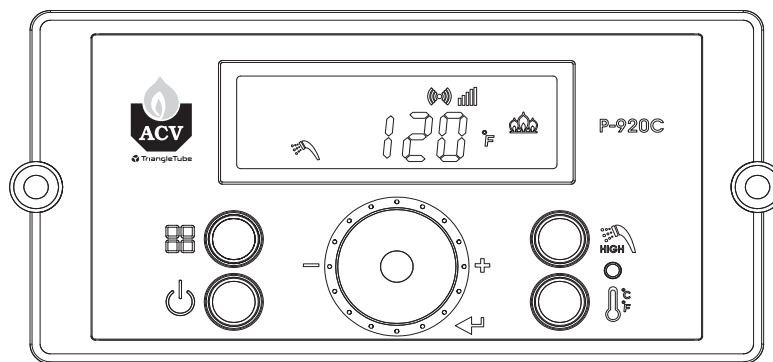

Indicate	Indicator
Current DHW temperature setpoint	1 ~ 4
If the flow is present	S24
If flame detected	S37
If lock mode is activated	S8, S11, S14
Temperature sign Celsius or Fahrenheit	S35 or S38
Communication state indicate	S15 ~ S19

Method of Operation

■ DHW Setpoint Change Mode

The display shows the following information during water heating temperature setpoint changes.

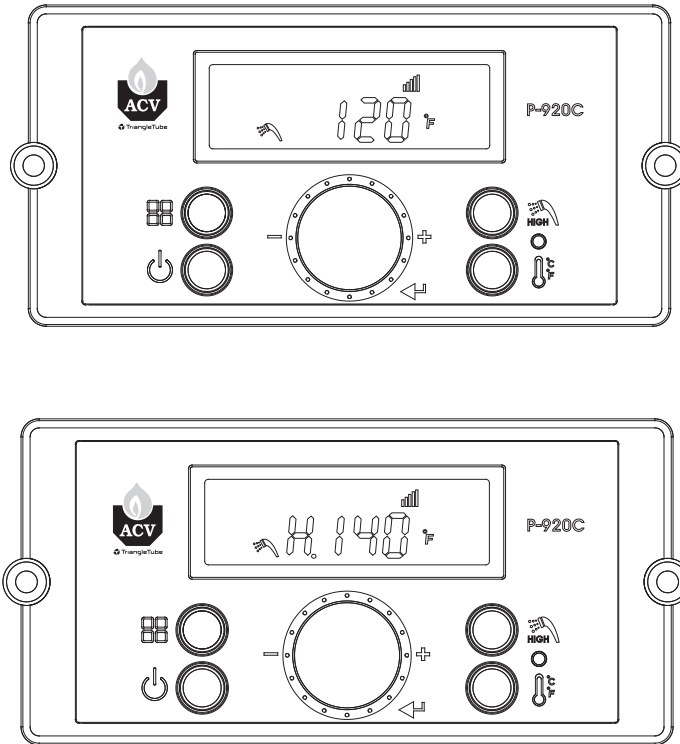

Indicate	Indicator
Current setpoint temperature	2, 3, 4
Temperature sign Celsius or Fahrenheit	S35 or S38
If display is connected to main controller, normally the communication state will be indicated.	S15 ~ S19
When DHW setpoint range is high : from 125°F (52°C) to 140°F (60°C)	1(H), S29
DHW display blinks.	S24

* Initial DHW setpoint is 120°F (49°C)

* 1st DHW set-point range is 95 ~125°F (35 ~ 52°C)

When button C  is pressed shortly at standby mode (not blinking), current DHW setpoint will be displayed and DHW icon will be blinking.

* 2nd DHW set-point range is 125 ~140°F (52 ~ 60°C).

When button C  is pressed continuously at standby mode (not blinking), current DHW setpoint will be displayed and DHW icon will be blinking. Also, caution mark(H.) will be presented.

Current DHW setpoint can be changed by rotating dial.

■ After changing temperature, user should press E button  (enter) in order to save the value.

- Changing temperature unit

When button D  is pressed continuously (more than 5 seconds), the temperature units will toggle. s

Method of Operation

■ Error mode

The display will show the following information when an Error occurs.

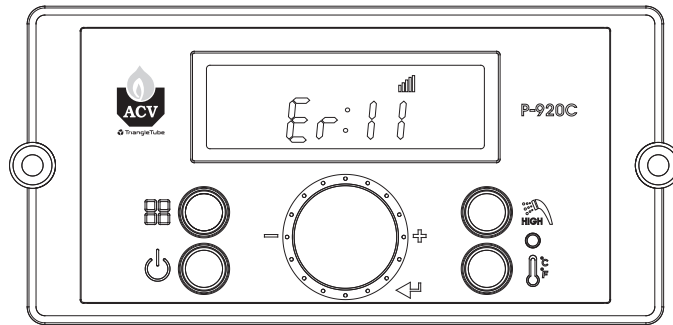

Indicate	Indicator
Error 'Er : ' sign Segment 1 is blinking at 1Hz	1, 2 ,S30
Error Code	3, 4
If display is connected to main controller, normally the communication state will be indicated.	S15 ~ S19

Method of Operation

Information mode

When button 'B'  is pressed shortly in standby mode, information display mode will be activated.

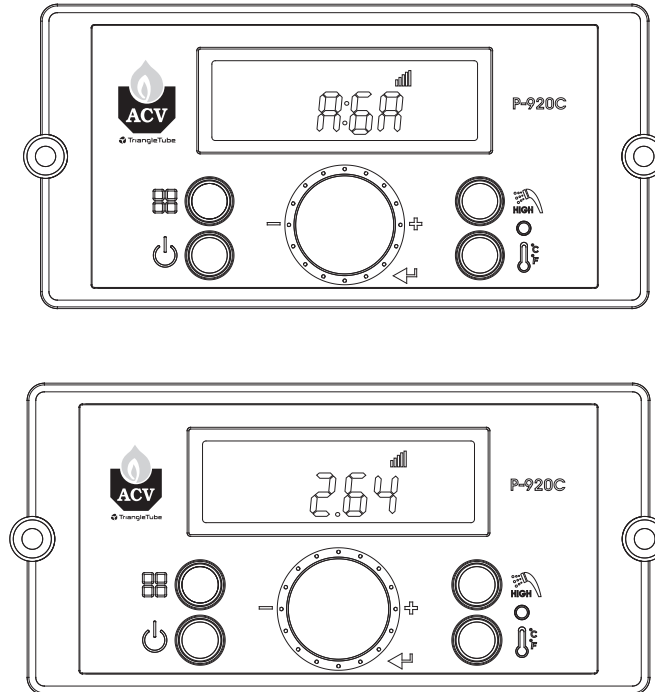

Index	Parameter	Description
A: Li or A: GA	DHW Flow	Current flow value(Li: L/m, GA: GPM)
b: Fr	Fan rpm	Current fan rpm value
C: Lc	Lock Mode	Lock mode is (On) or (oFF)
d: OP	OP Temperature	Current Operating Temperature
E: dH	DHW temperature	Current DHW temperature
F: Eh	Exhaust Temperature	Current Exhaust temperature
h: In	Inlet Temperature	Current Inlet Temperature
L:rt	Running Time	Display Running Time
L:rt	1: PH	Power Supply Time
	2: rh	Burner Operating Time
	3: rH	Burner Operating Time
	4: It	Ignition Attempts Number
	5: IH	Ignition Attempts Number
J: AG	AGM Position	AGM calibration

Scroll through items by turning the dial . Press the dial to view the currently selected item.

Method of Operation

■ Installer Mode

When button 'B'  is pressed for 5 seconds with the unit turned off via button 'A', installer mode will be activated.

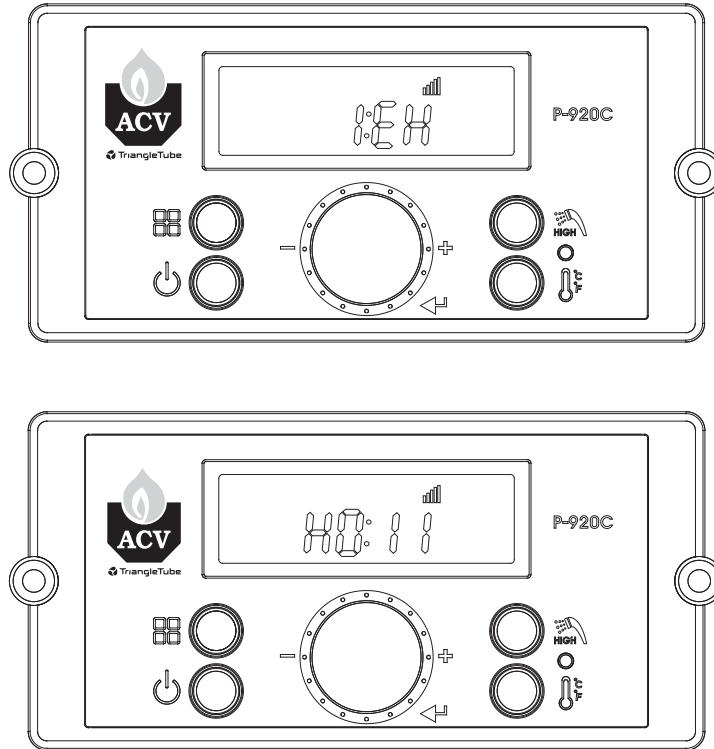

Index Numbers	Parameter	Description
1: EH	Error History	Previous fault codes (H0~H9)
2: cE	Clear Error History	Clears error history
3: In	System initialize	System reset
4: Fu	Flow units	L/m or GPM
5: FH	N/A	DO NOT ADJUST
6: FL	N/A	DO NOT ADJUST
7: dr	Reset Running time	Reset running time YES/No
8: dl	Reset igniting times	Reset igniting times YES/No
9: HA	High Altitude	High Altitude Setting (0: Nomal <1< 2<4 :High Altitude)
10: Cn	N/A	N/A
11: Cl	N/A	N/A
12: Eh	N/A	N/A

Scroll through items by turning the dial E .

Select an item to change by pressing button E . Then, the user can change the value by rotating dial E .

After changing, press button E to save the setting.

When button B is pressed again, installer mode will be changed back to power off mode.

Maintenance

■ Regular Maintenance

- This manual should remain with the Water Heater. After Water Heater installation is completed, the installation manual should be placed in a location near the Water Heater. Maintenance instructions should be carried out following the guidelines:

Daily	Check installation location. Check if water heater casing is closed. Check power source.
Monthly	Check vent pipe. Check air inlet pipe. Check relief valve. Check condensate outlet.
Every 6 Months	Check water heater piping (gas and water) Operate relief valve
No plan for long-term use.	Do not shut Water Heater down.

■ Maintenance procedures [Daily]

- Check installation location
To prevent potential severe personal injury, death or substantial property damage, remove all contaminated materials.
If contaminants are found :
Remove products immediately from the area.
In order to check the status of Water Heater, call a qualified service technician to inspect the Water Heater for possible damage from corrosion.
DO NOT store combustible materials, gasoline or any other flammable vapors or liquids near the Water Heater. Remove them immediately or store them other places.
- Check if WATER HEATER casing is closed.
Check if there is any problem with the Water Heater casing and the two upper and lower screws are tightened well. Water Heater casing must be closed while it is running.

■ Maintenance procedures [Daily]

- Check power source.
Make sure that the power cord is correctly connected. The power line is connected to the manual switch inside the Water Heater.
- Check status of the control panel.
Check for any debris on the buttons or display.

■ Maintenance procedures [Monthly]

- Check vent pipe.
Visually inspect the flue gas vent piping for any signs of blockage, leakage or deterioration of the piping. Contact a qualified service technician immediately if you find any problem.
- Check air inlet pipe.
Visually inspect the air inlet for obstructions. Inspect entire length of air piping to ensure the piping is intact and all joints are properly sealed. Call your qualified service technician if you notice any problems.
- Check relief valve.
Inspect the Water Heater relief valve and the relief valve discharge pipe for any signs of weeping or leakage. If the relief valve often weeps, immediately contact your qualified service technician for inspecting the Water Heater system.
- Check the condensate outlet.
While the Water Heater is running, check the discharge end of the condensate drain tubing.
Make sure that no flue gas is escaping from the condensate drain tubing.
If flue gas is continuously escaping, it is a serious problem. Call your qualified service technician for inspecting the Water Heater and condensate line.
- Check vent terminal screen.

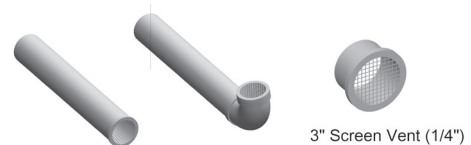

- Inspect vent terminal screen for debris.
Remove any debris found.

Maintenance

- Cleaning Air Intake Filter

- To properly maintain the water heater, you should clean air intake filter every month. A dirty air intake filter could cause unreliable operation.

To clean air intake filter:

1. Press Power button on the control panel to turn off the water heater.
2. Disconnect power supply to water heater.
3. Remove front cover of water heater.
4. Pull the filter out of air intake adapter.

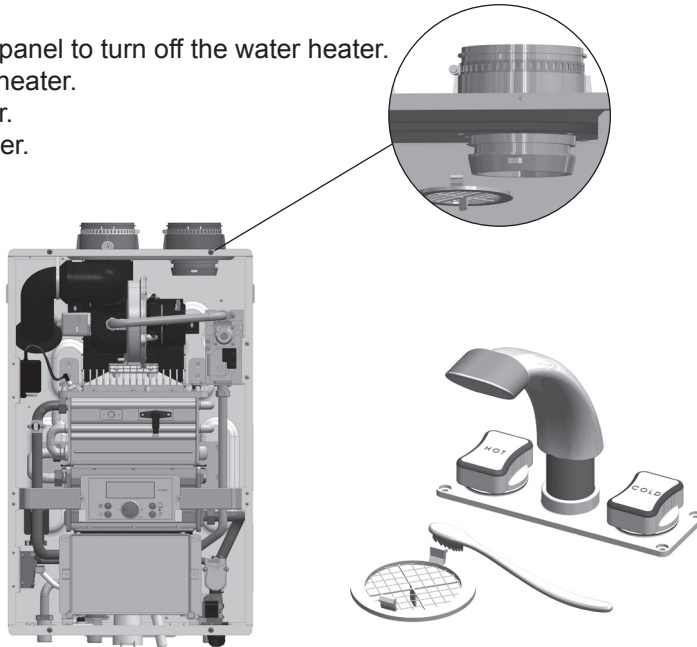

5. Remove the filter from the plastic assembly and clean it with a toothbrush and clean running water.
6. Dry the filter completely and then reinsert the filter into the plastic assembly.
7. Replace the front cover and then reconnect the power supply to the water heater.
8. Press Power button on the front panel to turn on water heater.

- Cleaning cold water Inlet Filter

1. Place a bucket under the appliance to collect the residual water inside the water heater.
2. Press Power button on the front control panel to turn off the electrical power to the water heater and then turn off the gas valve.
3. Close water supply valve on the inlet to the appliance. If there is no valve, turn off main water valve.
4. Open the hot water faucets completely.
5. Remove the cold water inlet filter. And then clean it with a toothbrush and clean running water.

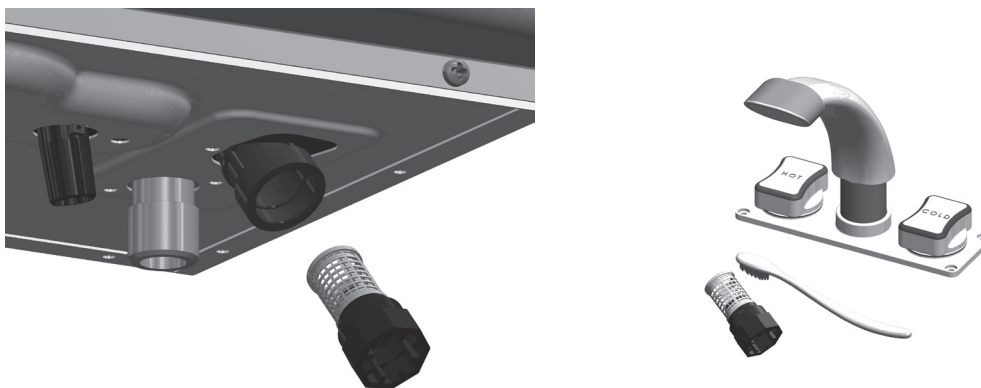

6. To refill the water heater, follow the steps of "Cleaning cold water Inlet Filter" in reverse.

Maintenance

- Flushing the Water Heater

Flushing the Heat Exchanger of the water heater is required for optimal performance. Refer to the following instructions carefully before attempting the procedure. If you do not understand the procedure, contact an authorized technician or licensed professional. Keep in mind that improper maintenance can void your warranty.

1. Disconnect electric power to the water heater.
2. Close the shutoff valves on both hot water outlet and cold water inlet lines. (V1 & V2)
3. Connect one hose "D1" to the valve "V3" and place the free end in the bucket. Connect another hoses "D3" to the circulation pump outlet and the cold water inlet line at the valve "V4". Connect other hose "D2" to the circulation pump inlet and place the free end in the bucket.

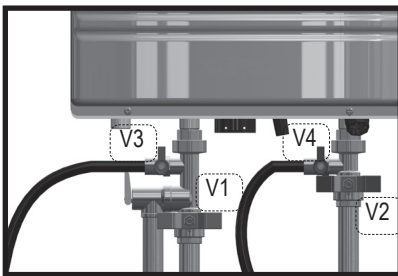

4. Pour the instantaneous water heater cleaning solution into the bucket. Place the hose (D1) and hose (D2) to the pump inlet into the cleaning solution.
5. Open service valves (V3 & V4) on the hot water outlet and cold water inlet lines.
6. Turn on the circulation pump (Operate the pump and allow the cleaning solution to circulate through the water heater for at least 1 hour at a rate of 4 gallons per minute.)
7. Rinse the cleaning solution from the water heater as follows:
 - Remove the free end of the drain hose (D1) from the bucket.

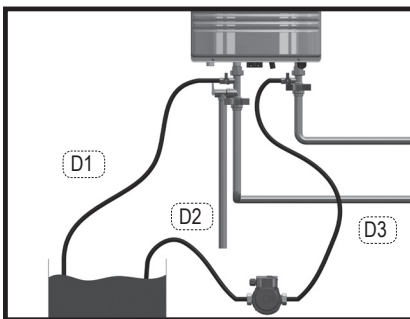

- Close service valve, (V4), and open shutoff valve, (V2). Do not open shutoff valve, (V1).
 - Allow water to flow through the water heater for 5 minutes.
 - Close shutoff valve (V2).
8. Disconnect all hoses.
 9. Remove the cold water inlet filter from the water heater and clean out any residues.
 10. Reinsert the filter and ensure the filter cap is securely tightened.
 11. Connect electrical power to the water heater.

■ Maintenance procedures [Every 6 Months]

- Check piping. (gas and water)

Visually inspect for leaks around internal water piping. Also inspect external water piping, circulators, relief valve and fittings. Immediately call a qualified service technician to repair any leaks.

Leaks must be fixed by a qualified service technician immediately. Failure to comply with this instruction could result in severe personal injury, death or substantial property damage.

⚠ WARNING

Leaks must be fixed by a qualified service technician immediately. Failure to comply with this instruction could result in severe personal injury, death or substantial property damage. This discharge line must be installed by a qualified heating installer or a service technician.

- Operate relief valve

Before following the procedure, verify that relief valve outlet has been piped to a safe place of discharge, avoiding any possibility of scalding from hot water. If water flows freely, release the lever and allow the valve to seat. Watch the end of the relief valve discharge pipe to ensure that the valve does not weep after the line has had time to drain. If the valve weeps, lift the seat again to attempt to clean the valve seat. If the valve continues to weep, contact your qualified service technician for inspecting the valve and system. If water does not flow from the valve even though you have lifted the lever completely, the valve or discharge line may be blocked. Shut down the Water Heater immediately. Call your qualified service technician to inspect the water heater and system.

Troubleshooting

■ Troubleshooting

Symptom	Possible Causes
Burner does not ignite even if hot water is opened.	Make sure that the ON/OFF button on the Control Panel has been turned ON.
	If the monitor on the Control Panel is blank, make sure the power cord is plugged in and fuses on the main controller are good.
	Make sure that water flows to the unit. The heater will be running when the inlet water flow sensor detects flow over 0.5gpm.
	Make sure the cold and hot water pipes are not plumbed in reverse.
	Make sure that water and gas supply lines are opened.
	Make sure that water lines are not frozen.
Outlet water is not hot enough.	Make sure that the temperature setting on the unit is not too low.
	Make sure that the filter in the cold water inlet line is not clogged with debris.
	Make sure that the gas supply type is correct.
	Check if the supply and manifold gas pressures are in accordance with specifications.
	Make sure that the water flow sensor with three wires has been properly connected on the top of heat exchanger.
Outlet water is too hot.	Make sure that the temperature setting on the unit is not too hot.
	Make sure that the filter in the cold water inlet line is not clogged with debris.
	Make sure that the gas supply type is correct.
Hot water temperature	Make sure that the filter in the cold water inlet line is clean.
	Check if the supply gas pressure is sufficient.
The blower is still operating after the combustion stops.	This is normal because the blower keeps operating for 3 minutes.
I can't change the temperature setting above 125°F on the Control Panel.	This is a safety device to prevent scalding. Hot water temperature over 125°F can cause severe burns instantly or death.
Abnormal sounds come from unit during operation.	A leak of combustion gas between sealed chamber and exhaust duct inside the unit.
	Improper venting termination, make sure that the venting termination complies with specification.
	Check if the supply gas pressure is sufficient. Insufficient gas pressure can cause unstable burner flame and noise.

Troubleshooting

■ Diagnostics and suggested corrective actions

This controller is able to record information about the water heater condition at the time of the ten previous faults or error. The control will display the following information.

Display	Condition	Diagnostic	Corrective Action(s)
Nothing shown on display and blower running at full speed.	Control is not receiving power.	Check wiring for short circuit or incorrect wiring.	Correct wiring per wiring diagram.
		Check for 14V output of panel wire.	Push the 'A' button of control panel.
Nothing is shown on display and no other Water Heater components are operating.	Control is not receiving 120V power.	Is there 120 Volts at the manual switch?	Correct the power supply from the manual switch.
		Check the water heater inside power manual switch.	Turn on the manual power switch inside the water heater case.
		Check for 120 volts at the line voltage terminal inside the water heater case.	Correct wiring inside the water heater case using the wiring diagram in this manual.
Nothing is shown on control panel, but water heater is operating.	Occurs when the communication is lost from the control to the display.	Check for loose connections and proper pin alignment/ engagement on the Control's plug.	Check for continuity on the wire harness from the display to the control panel. See repair parts section for proper replacement part.
		Cycle power off and on using water heater power switch and check for operation.	Replace with new display module. See repair parts section for proper replacement part.
TEMPERATURE RISE TOO QUICKLY	Occurs when supply water temperature in heat exchanger rises faster than 2°F per second during the first two minutes the burner is on.	Automatically resets after a few minutes delay or use manual reset.	See TEMPERATURE SENSOR and follow procedures for loose connections.
TEMPERATURE SENSOR	Occurs when a temperature sensor has electrically shorted (SHORT) or has become disconnected (OPEN).	Reset by pressing the On/Off button on the display.	Check all the temperature readings of the water heater in the information menu to determine if any sensors are currently displayed as SHORT or OPEN.
			Check wire harness for loose connections and pin engagement at sensor Connection and Control module.
			If problem persists after checking items above, replace Control.

Troubleshooting

Display	Condition	Diagnostic	Corrective Action(s)
FLAME FAULT	Occurs when flame is detected when there should be no flame	Reset using manual switch. Reset screen on control panel. (Power button)	Burner may be operating too hot due to incorrect combustion.
			Check for flame at burner through observation port with burner off. If flame continues after shutdown, replace gas valve.
BLDC Fan FAULT	BLDC Fan is unable to reach required speed or 0 RPM when it is turned off.	Reset using manual switch. Reset screen on control panel. (Power button)	Check wire harness for loose connections and pin engagement at blower connections.
			Water heater is in standby mode and fan is not running. If FAN SPEED is not 0 RPM then replace the fan.
IGNITION FAULT	Water heater failed to light after 10 attempts.	Reset using manual switch. Reset screen on control panel. (Power button)	Check for spark through sight glass.
			Check incoming gas pressure to water heater when off and during ignition. Adjust within limits on rating plate.
			Check for vent pipe and intake pipe restrictions or blockage
			Check burner fasteners and gaskets
			Check air intake pipe and orifice
GAS VALVE FAULT	The Control has detected a problem with its gas valve output circuit	Reset using manual switch. Reset screen on control panel. (Power button)	Check wire harness connections between gas valve and Control.
			If lockout reoccurs, replace Gas valve.

Error Codes

Error codes

Error Code	Error Code Description	Possible Remedies	Lockout Type
11	Ignition has Failed 10 (Ten) Times	<p>Press the Power button to clear the Error Code.</p> <p>If Error happens again:</p> <ol style="list-style-type: none"> 1. Monitor the gas pressure to the water heater while in operation. Ensure pressure is between 3.5 and 14" WC. 2. Check gas valve wire. Ensure connection is secure. 3. Check flame detection sensor. Ensure connections are secure. Normal operating settings are more than 2.5DC before ignition, less than 2.5DC after ignition. 4. Check igniter transformer for proper connection. 5. Clean the igniter with steel wool to remove oxides. Ensure proper separation (3-4 mm). 6. Replace the spark igniter if damaged. 7. Assure that the flame is stable when lit. 8. If the problem persists, replace the main control. 	Hard Lock
16	Operating Temperature Sensor or DHW Sensor detects Water Temperature Greater than 199°F (93°C)	<p>This Error Code will go away when the DHW temperature decreases.</p> <p>If Error happens again:</p> <ol style="list-style-type: none"> 1. Check if dip switch High Fire setting is ON. Switches 6 and 7 should be OFF for normal operation. 2. Check if DHW pipe is blocked. Ensure there is enough water flowing to the water heater. 3. Check DHW sensor at DHW outlet. If resistance is zero, replace the sensor. 4. Check Operating Temperature sensor at the heat exchanger. If resistance is zero, replace the sensor. 5. If the problem persists, replace the main control. 	Soft Lock
20	High Limit Overheat Switch – Closed is Normal, Open is Fault	<p>Press the Power button to clear the Error Code.</p> <ol style="list-style-type: none"> 1. Inspect the High Limit Overheat switch. Ensure proper connections. 2. Check High Limit Overheat switch resistance. If resistance is zero, replace the switch. 3. If the problem persists, replace the main control. 	Hard Lock
29	APS/Condensate – Closed is Normal, Open is Fault (Condensate Drain Trap)	<p>Press the Power button to clear the Error Code.</p> <ol style="list-style-type: none"> 1. Check APS/Condensate and main controller connections. Ensure all are secure. 2. Check APS/Condensate resistance. If resistance is zero, replace the switch. 3. Check APS/Condensate hose. Ensure it is connected and in good condition. 4. Check condensate line and termination for blockages. 5. Check exhaust vent for blockages. 6. If the problem persists, replace the main control. 	Hard Lock
31	Inlet Water Sensor Open or Short	<p>This Error Code will go away when inlet water temperature decreases.</p> <p>If Error happens again:</p> <ol style="list-style-type: none"> 1. Check inlet water temperature sensor. Ensure connections are secure. 2. Check sensor resistance. If resistance is zero, replace the sensor. 3. If the problem persists, replace the main control. 	Soft Lock
32	DHW Sensor Open or Short	<p>This Error Code will go away when outlet water temperature decreases.</p> <p>If Error happens again:</p> <ol style="list-style-type: none"> 1. Check DHW outlet temperature sensor. Ensure connections are secure. 2. Check sensor resistance. If resistance is zero, replace the sensor. 3. If the problem persists, replace the main control. 	Soft Lock

Error Codes

Error Code	Error Code Description	Possible Remedies	Lockout Type
33	Operating Temperature Sensor Open or Short	This Error Code will go away when operating water temperature decreases. If Error happens again: 1. Check operating temperature sensor. Ensure connections are secure. 2. Check sensor resistance. If resistance is zero, replace the sensor. 3. If the problem persists, replace the main control.	Soft Lock
35	Exhaust Sensor Open or Short	This Error Code will go away when exhaust temperature decreases. If Error happens again: 1. Check exhaust temperature sensor. Ensure connections are secure. 2. Check sensor resistance. If resistance is zero, replace the sensor. 3. Check exhaust vent for blockage. 4. If the problem persists, replace the main control.	Soft Lock
39	Flame Detected after Exiting a Flame On Condition	This Error Code will go away when the false flame condition is remedied. If Error happens again: 1. Check the water heater cover. Ensure it is secure. Flame detection sensor can detect an external light source. 2. Check flame detection sensor. Ensure connections are secure. Normal operating settings are more than 2.5DC before ignition, less than 2.5DC after ignition. 3. If the problem persists, replace the main control.	Soft Lock
40	Gas Leakage is Detected for 10 Minutes, or three times within One Hour (Greater than 5 Seconds Each Time)	IMPORTANT: If you smell gas, STOP! Follow the instructions on the cover of this manual, and call a qualified service technician or the gas utility. Press the Power button to clear the Error Code. If Error happens again: 1. Check the water heater cover. Ensure it is secure. 2. Check gas connections for leakage with a soapy solution. Fix any leaks. 3. Check condition of the burner assembly. 4. If the problem persists, replace the main control.	Hard Lock
41	Fan Speed too High with Flame On	Press the Power button to clear the Error Code. If Error happens again: 1. Check the vent connections for blockages. 2. Check the burner assembly. 3. Check fan operation. If fan appears to be operating normally but RPMs are too low or too high, replace the fan. 4. If the problem persists, replace the main control.	Hard Lock
43	Burner Overheat Switch Open	Press the Power button to clear the Error Code. If Error happens again: 1. Check burner overheat switch connections. Ensure connections are secure. 2. Check switch resistance. If resistance is zero, replace the switch. 3. If the problem persists, replace the main control.	Hard Lock
61	Fan Speed Feedback Signal Abnormal	This Error Code will go away when the condition is remedied. If Error happens again: 1. Check the connections to the fan. Ensure all are secure. 2. If the fan does not rotate during the ignition sequence, check for 120V power at the fan connection. If 120V power is present at the control, replace the fan. If the blower does not have 120V power, check power at the control. If 120V power is not present at the control, replace the control. 3. If the problem persists, replace the main control.	Soft Lock

Error Codes

Error Code	Error Code Description	Possible Remedies	Lockout Type
65	Supply Water Valve Error	<p>Press the Power button to clear the Error Code.</p> <p>If Error happens again:</p> <ol style="list-style-type: none"> 1. Turn power OFF and ON at the main power switch internal to the water heater. 2. Check wiring connections to supply water valve. Ensure all are secure. 3. Replace supply water valve. 4. If the problem persists, replace the main control. 	Hard Lock
66	Mixing Valve Error	<p>Press the Power button to clear the Error Code.</p> <p>If Error happens again:</p> <ol style="list-style-type: none"> 1. Turn power OFF and ON at the main power switch internal to the water heater. 2. Check wiring connections to mixing valve. Ensure all are secure. 3. Replace mixing valve. 4. If the problem persists, replace the main control. 	Hard Lock
67	AGM Error	<p>Press the Power button to clear the Error Code.</p> <p>If Error happens again:</p> <ol style="list-style-type: none"> 1. Turn power OFF and ON at the main power switch internal to the water heater. 2. Ensure fan inlet hole is completely open after turning the power OFF and ON. 3. Check wiring connections to the AGM. Ensure all are secure. 4. Check AGM operation. 5. Replace AGM. 6. If the problem persists, replace the main control. 	Hard Lock
72	Flame Signal Detected before Ignition	<p>This Error Code will go away when the condition is remedied.</p> <p>If Error happens again:</p> <ol style="list-style-type: none"> 1. Check the water heater cover. Ensure it is secure. Flame detection sensor can detect an external light source. 2. Check flame detection sensor. Ensure connections are secure. Normal operating settings are more than 2.5DC before ignition, less than 2.5DC after ignition. 3. If the problem persists, replace the main control. 	Soft Lock
73	DIP Switch is abnormal	<p>This Error Code will go away when the condition is remedied.</p> <p>If Error happens again:</p> <ol style="list-style-type: none"> 1. Check dip switches. Ensure switches match the ratings plate requirements of the water heater. 2. If the problem persists, replace the main control. 	Soft Lock
76	Poor Communication	<p>This Error Code will go away when the condition is remedied.</p> <p>If Error happens again:</p> <ol style="list-style-type: none"> 1. Check connections from main control to display panel. 2. If the problem persists, replace the display and/or the main control. 	Soft Lock
94	Exhaust NTC detects Vent Temperature is Greater than 149°F (65°C)	<p>This Error Code will go away when the condition is remedied.</p> <p>If Error happens again:</p> <ol style="list-style-type: none"> 1. Check if dip switch High Fire setting is ON. Switches 6 and 7 should be OFF for normal operation. 2. Check exhaust temperature sensor. Ensure connections are secure. 3. Check sensor resistance. If resistance is zero, replace the sensor. 4. Check exhaust vent for blockage. 5. If the problem persists, replace the control. 6. If the problem persists, replace the heat exchanger. <p>* In Case Of PVC Vent Setting, Exhaust NTC detects Vent Temperature is Greater than 149°F (65°C)</p>	Hard Lock

Error Codes

1. Flame Detection

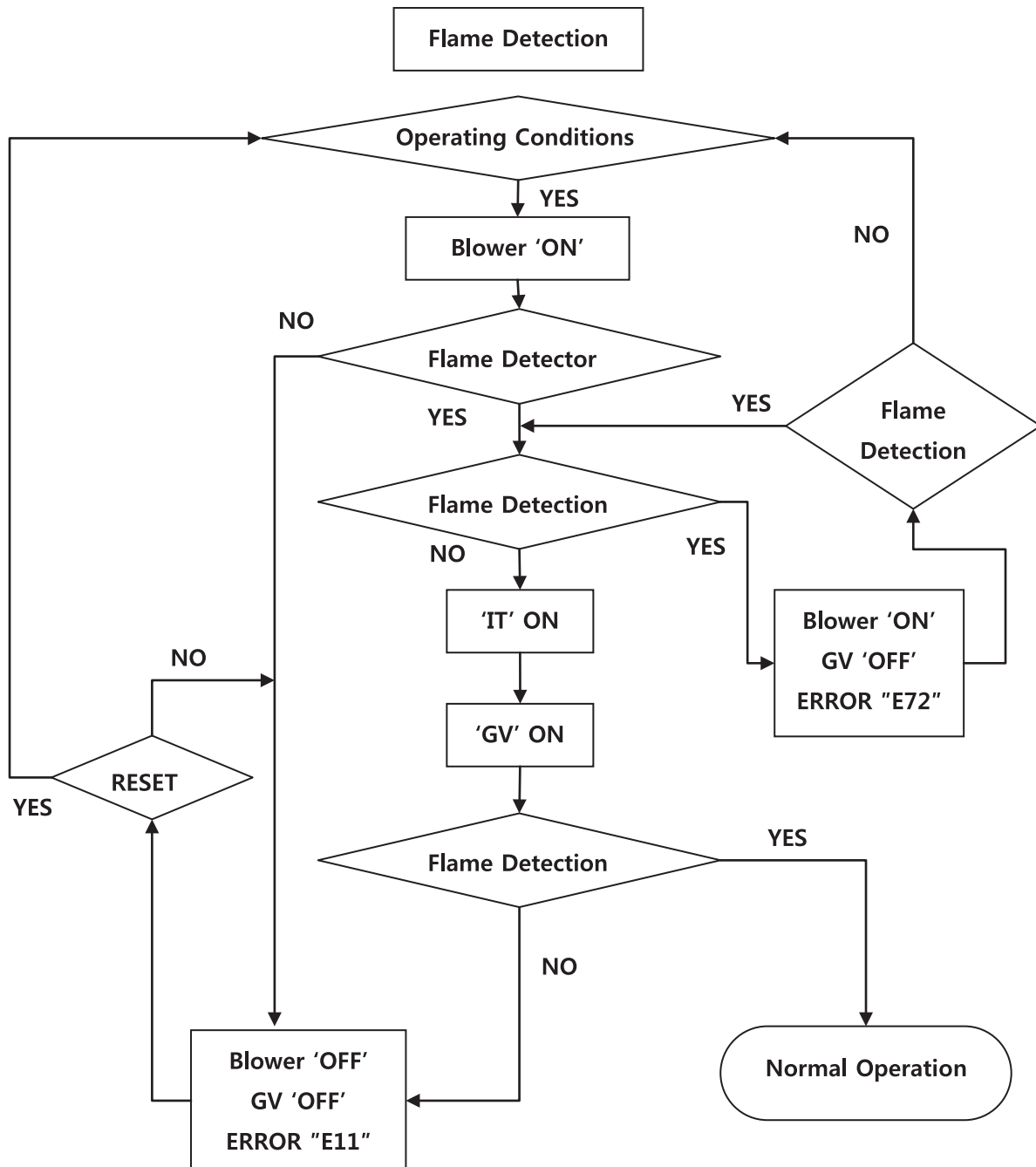

Error Codes

2. Gas Detection

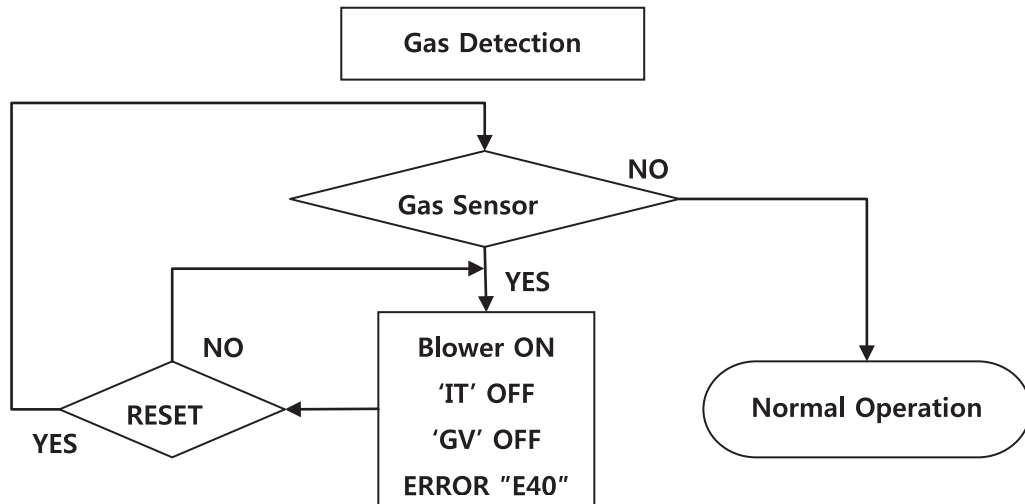

3. Sensing air pressure.

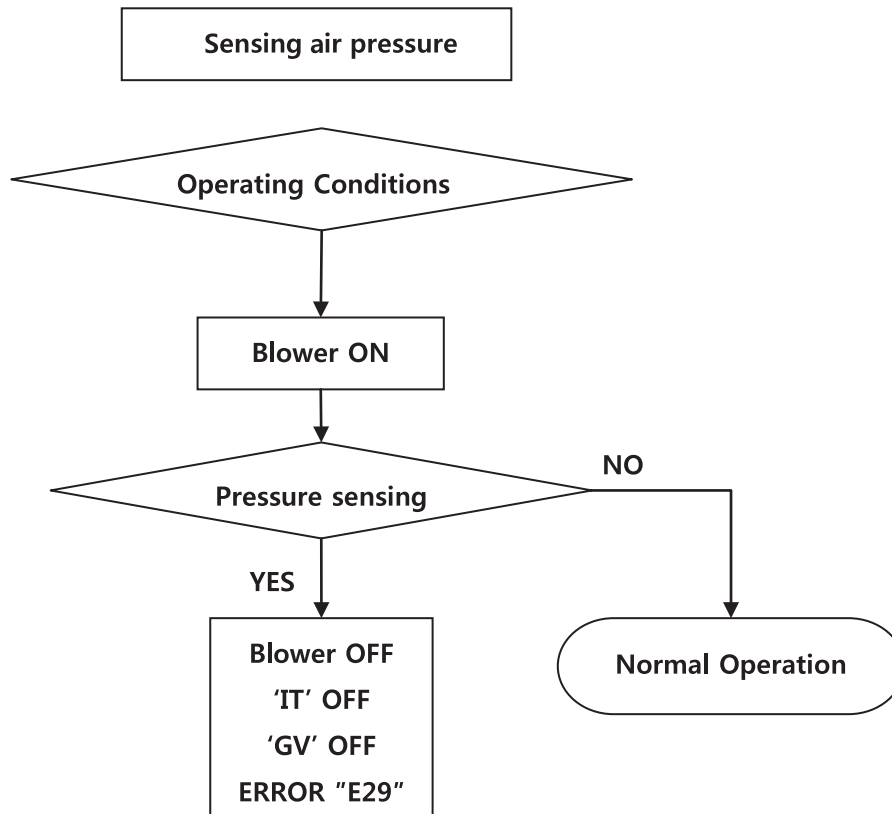

Error Codes

4. 'I/T', 'DHW', 'OP' Sensor detects

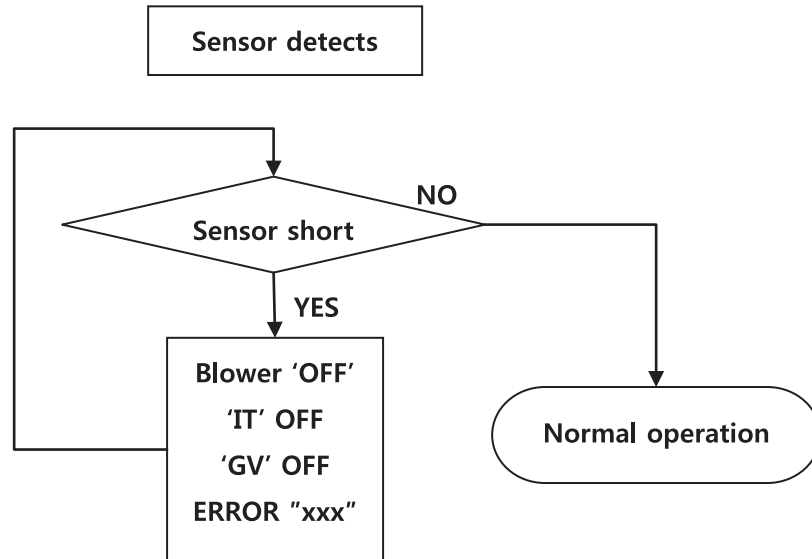

Error code	contents
E31	Inlet water NTC open or short
E32	DHW NTC open or short
E33	OP NTC open or short
E35	Exhaust NTC open or short

Additional quality water heating equipment available from Triangle Tube

SMART INDIRECT FIRED WATER HEATERS



- Exclusive Tank-in-Tank design
- Stainless steel construction
- Available in 7 sizes
- Limited LIFETIME residential warranty
- 6 year limited commercial warranty
- Self cleaning/self descaling design

TTP BRAZED PLATE HEAT EXCHANGERS

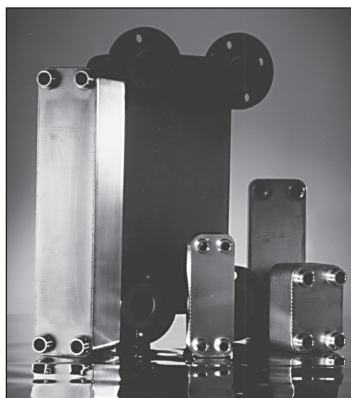

- For domestic water, snow melting, radiant floor
- Plates made of stainless steel, with a 99.9% copper and brazed, ensuring a high resistance to corrosion
- Self cleaning and self descaling
- Computerized sizing available from Triangle Tube/Phase III
- Available in capacities from 25,000 BTU/hr to 5,000,000 BTU/hr

PRESTIGE CONDENSING WALL MOUNTED BOILER



- 95% AFUE
- Fully modulating
- Natural gas or propane
- Stainless steel construction
- Direct vent with standard schedule 40 PVC
- Outdoor Reset



1240 Forest Pkwy, Suite 100 • West Deptford, NJ 08066
p (856) 228 8881 f (856) 228 3584 www.triangletube.com