

QAA73.210

Programmable Room Unit

For Single Boiler Installations

**INSTALLATION, COMMISSIONING AND
SERVICING INSTRUCTIONS**

IMPORTANT NOTE

**THESE INSTRUCTIONS MUST BE READ
AND UNDERSTOOD BEFORE INSTALLING,
COMMISSIONING, OPERATING OR
SERVICING EQUIPMENT**

Customer After Sales Services

Telephone: **01202 662555** E-mail: **service@hamworthy-heating.com** Fax: **01202 662522**

Technical Enquiries

To supplement the detailed technical brochures, technical advice on the application and use of products in the Hamworthy Heating range is available from our technical team in Poole and our accredited agents.

Site Assembly

Hamworthy offer a service of site assembly for many of our products where plant room access is restricted. Using our trained staff we offer a higher quality of build and assurance of a boiler built and tested by the manufacturer.

Commissioning

Commissioning of equipment by our own engineers, accredited agents or specialist sub-contractors will ensure the equipment is operating safely and efficiently.

Service Contracts

Regular routine servicing of equipment by Hamworthy service engineers inspects the safety and integrity of the plant, reducing the risk of failure and improving performance and efficiency. Service contracts enable you to plan and budget more efficiently.

Breakdown service, repair, replacement

Hamworthy provide a rapid response breakdown, repair or replacement service through head office at Poole and accredited agents throughout the UK.

Spare Parts

We offer a comprehensive range of spare parts, providing replacement parts for both current and discontinued products. Delivery options are available to suit you. Please refer to our website for more details.

QAA73.210 PROGRAMMABLE ROOM UNIT

For Single Boiler Applications

**Installation, Commissioning
and Operating Instructions**

**NOTE: THESE INSTRUCTIONS SHOULD BE READ AND UNDERSTOOD BEFORE
ATTEMPTING TO INSTALL, COMMISSION OR OPERATE THIS UNIT**

**PUBLICATION NO. 500001305
ISSUE 'B'
June 2022**

CONTENTS

	PAGE
1.0 Introduction	1
2.0 Handling and Installation	2
2.1 Location	
2.2 Installation	
2.3 Electrical installation	
3.0 Commissioning	5
4.0 Operation	10
4.1 Display	
4.2 Programming BMU parameters	
4.3 Room unit settings	
4.4 Time switch program	
4.5 Cooling circuit	
4.6 Domestic Hot Water	
4.7 Configuration	
4.8 Functions	
5.0 Fault Finding	12
6.0 Technical Data	12
7.0 Single Heating Zone Installations	13
8.0 Single Heating Circuit with Domestic Hot Water	27
9.0 Twin Heating Circuits with Domestic Hot Water	30
Appendix A: Sensors	34

1.0 Introduction

The Hamworthy QAA73.210 is a digital multi-functional room unit for one or 2 heating circuits and d.h.w. control.

The boiler control LMU64 delivers the outside temperature and other information to the QAA73.210 room unit via the OpenTherm communication interface. Based on the outside temperature, the room temperature and a number of other parameters, the interface calculates the required flow temperature setpoints for one or 2 heating circuits and transmits them to the boiler control. In addition, the d.h.w. temperature setpoint is transmitted to the boiler control.

The optimization and weather compensation functions offer energy savings without sacrificing comfort. The room sensor required for that purpose is integrated within the unit.

Features

- Operating sections (operating levels) based on ergonomic and functional considerations
- Clear assignment of basic functions:
- Operating mode, setpoint adjustment and occupancy button
- A number of actual values can be accessed via the Info button
- Additional functions can be programmed after opening the cover
- Special service level with protected access
- Every setting or change is displayed and thus acknowledged
- Yearly clock with automatic summer- / wintertime changeover
- One heating program per heating circuit with up to 4 heating periods per day can be selected on an individual basis
- D.h.w. program with up to 4 heating periods per day can be selected on an individual basis



- Holiday program
- The heating programs and the d.h.w. program can be reset to their default settings
- Programming lock (e.g. for child-proofing)
- Special mode for setting the parameters of Siemens boiler control systems
- Weather-compensated flow temperature control while giving consideration to the building's thermal dynamics
- Weather-compensated flow temperature control with room compensation
- Pure room temperature control
- Effect of room temperature deviation can be adjusted
- Optimum start / stop control
- ECO functions (24-hour limit switch, automatic summer / winter changeover)
- Room temperature switching differential for limiting the room temperature
- Adjustable maximum limit of flow temperature (especially in connection with floor heating systems)
- Limitation of the rate of increase of the flow temperature setpoint
- Frost protection for the building, frost warning
- D.h.w. control with release and pre-selection of setpoint for the boiler controller
- Anit-legionella function
- Integrated yearly clock with a reserve of at least 12 hours
- Elegant housing made of recyclable plastic
- Communication with the boiler control via OpenTherm interface
- Power supply via OpenTherm interface

Range of Products

- Boiler Management Unit Premix TOP LMU64
- Third party boiler control with OpenTherm interface Room unit with OpenTherm interface QAA73.210

Product Liability

- When using the products, all requirements specified under 'Technical Data' must be observed
- The local regulations for electrical installation must be complied with.

2.0 Handling and installation

2.1 Location

- In the main occupancy room or reference room
- The place of installation should be chosen so that the sensor can capture the room temperature as accurately as possible, without being affected by direct solar radiation or other heating or cooling sources
- Mounting height should be approximately 1.5 meters above the floor
- The unit can be fitted to most commercially available recessed conduit boxes or directly on the wall

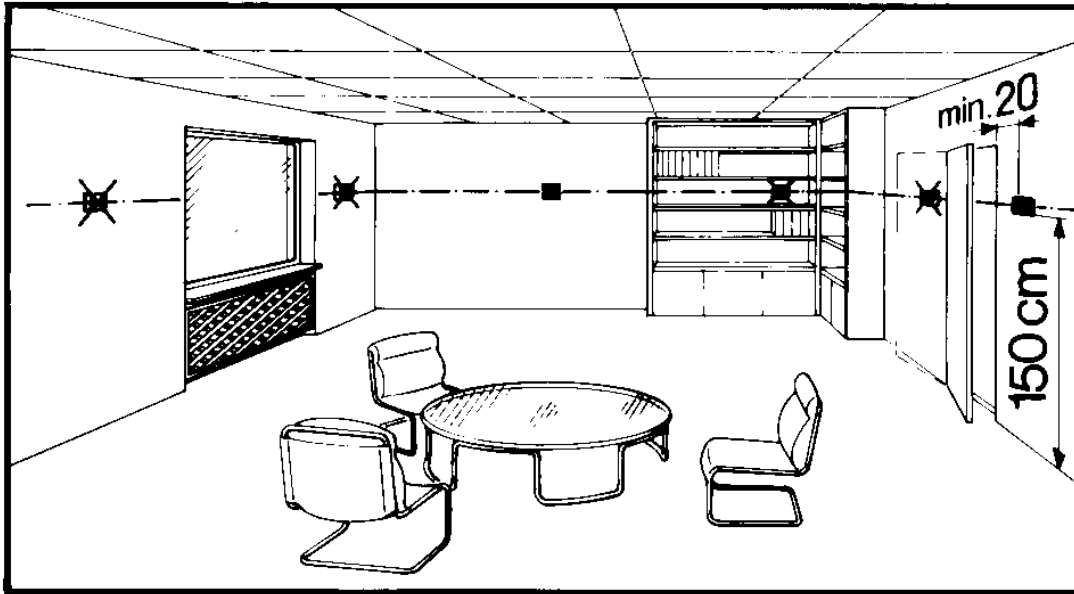

2.2 Installation

- Wall
- Boiler control panel (with the help of clips)

The controller may not be exposed to dripping water
Permissible ambient temperature: 0...50 °C

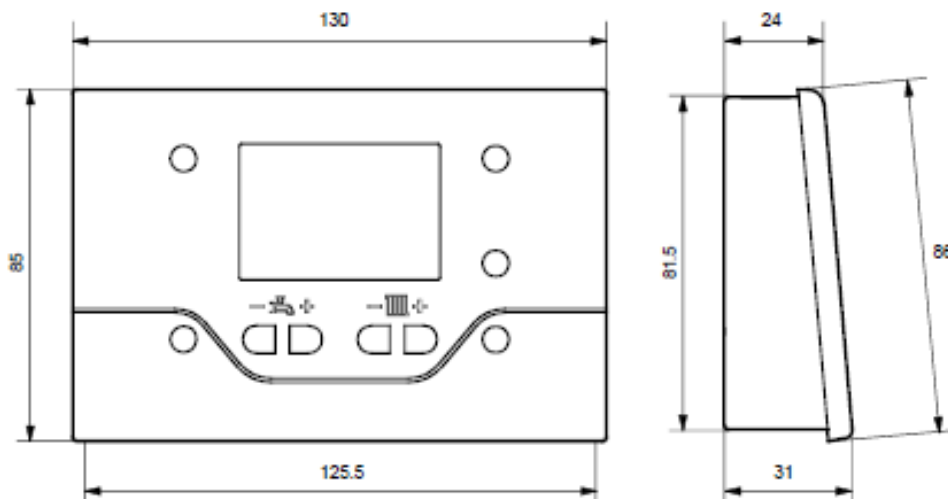

Wall Mounting

Open the unit at the bottom and remove the base from the housing front.



Pull the interface cable through the opening of the base and connect it to the screw terminals.



Fit the base to the walls with screws



Engage the housing front at the top of the base and close the unit to the bottom.



2.3 Electrical Installation

The local regulations for electrical installations must be complied with.



- 1 COA Open Therm terminal A (interchangeable)
- 2 COB Open Therm terminal B (interchangeable)

Note: 23mA max.

OpenTherm Communication Interface

For protection of the OpenTherm interface from electromagnetic disturbance, cables used for the OPENTHERM INTERFACE connections should be completed using shielded two core cable. Preference should be given to wire mesh shielded twisted cables.

In the installation the two ends of the cable must be connected to a reference potential (building ground).

To further protect the OPENTHERM INTERFACE from electromagnetic disturbance these should be separated from mains cables, preferably run in separate conduits or ducts. Where mains cables and OPENTHERM INTERFACE cables must be run in the same duct a central divider should be used to separate the OPENTHERM INTERFACE cables from the mains cables.

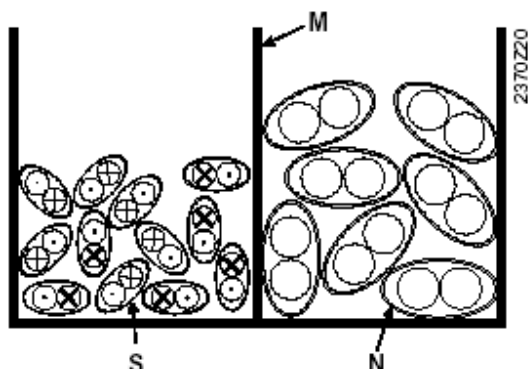

OPENTHERM INTERFACE Power Supply

The power supply for the OpenTherm communication interface and the QAA73 room controller is supplied from the boiler LMU64 controller.

Cables used for installing the OpenTherm communication interface power supply must have cross-sectional area of 1.5mm².

OpenTherm Communication Interface Cable Lengths

Using non interchangeable copper cable 1.5mm² the maximum permitted Interface cable length, including all branches, is 50 metres.

Connecting the Interface cable

The OpenTherm communication interface cable must be connected to terminals GND(-) and LINE(+) of the LMU64 and terminals 1 & 2 of the QAA73 room controller. The room controller terminals are volt free therefore polarity is not critical.

Communication with boiler control

For communication between the QAA73.210 and boiler control, the OpenTherm Plus protocol is used.

The parameters displayed only in OpenTherm Plus mode are appropriately identified in the parameter lists.

The following descriptions of the individual parameters refer to the use of OpenTherm Plus and are based on the assumption that the relevant functions are supported by boiler control. Only then is the full functionality of the QAA73.210 ensured so that the most common applications can be fully covered

If a parameter is not supported by boiler control, the display shows 3 strokes – – – in place of a value

- S = Signal Lines
- N = Mains Cables
- M = Metal Duct with Metal Wall

3.0 Commissioning

Prior to commissioning the controller, make the following checks:





- Correct mounting
- Correct connection to OpenTherm interface
- End user parameters are set as required
- Heating engineer parameters are set in compliance with plant requirements
- OEM parameters are set in compliance with technical requirements

The heating plant is started up via boiler control. To make the functional check, the individual functions of the room unit are checked in the plant.

Parameter Settings for the End user.

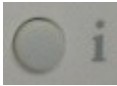
The following settings can be made to meet the individual needs of the end user.

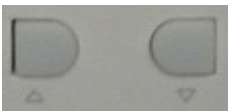

For specific applications and details regarding which parameters to change please refer to the relevant section of this manual.

	Buttons	Explanation
1		Press the Info button for at least 3 seconds. This will take you directly to the programming level "End user".
2		The display shows a number of operating pages. Press the line selection buttons to select the required operating page. To confirm, press OK.
3		The display shows a number of operating pages. Press the line selection buttons to select the required operating line. To confirm, press OK.
4		The display shows the value flashing. Press the line selection buttons until value is correct. To confirm, press OK
5		By pressing the ESC button, you come back to operating page selection.
6		By pressing the ESC button, you leave the programming level.

If no buttons are pressed for approx. 1 minute, the room unit will automatically leave the programming level.

User levels:

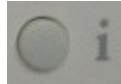
The user levels only allow authorized user groups to make settings. To reach the required user level, proceed as follows:

	Buttons	Explanation
1		Press the Info button for at least 3 seconds. This will take you directly to the programming level "End user".
2		Press the Info button for at least 3 seconds. This will take you to the user level selection.
3		You are now given a choice of user levels. Press the line selection buttons to select the required user level. To confirm, press OK. You are now on the required user level.

The following user levels are available

USR = End user

INST = Heating engineer

OEM = OEM

To reach the OEM level, the relevant code must be entered.

The table opposite shows all available settings up to the heating engineer level. However, certain operating lines may be hidden, depending on the type of unit.

E = End user, F = Heating engineer, O = OEM

Overview of user Parameters:

Operating line	Operating level	Function	Factory setting	Range	Unit
TIME					
hh:mm	E	Hours/minutes		00:00...23:59	hh:mm
DAY	E	Week day		1...7	
TSPHC					
MO...SU	E	Day selection	MO	1...7	
ON 1	E	1st phase on	06:00	00:00...23:59	hh:mm
OF 1	E	1st phase off	22:00	00:00...23:59	hh:mm
ON 2	E	2st phase on	24:00	00:00...23:59	hh:mm
OF 2	E	2st phase off	24:00	00:00...23:59	hh:mm
ON 3	E	3st phase on	24:00	00:00...23:59	hh:mm
OF 3	E	3st phase off	24:00	00:00...23:59	hh:mm
ON 4	E	4st phase on	24:00	00:00...23:59	hh:mm
OF 4	E	4st phase off	24:00	00:00...23:59	hh:mm
TSPCC 1)					
MO...SU	E	Day selection	MO	1...7	
ON 1	E	1st phase on	10:00	00:00...23:59	hh:mm
OF 1	E	1st phase off	18:00	00:00...23:59	hh:mm
ON 2	E	2st phase on	24:00	00:00...23:59	hh:mm
OF 2	E	2st phase off	24:00	00:00...23:59	hh:mm
ON 3	E	3st phase on	24:00	00:00...23:59	hh:mm
OF 3	E	3st phase off	24:00	00:00...23:59	hh:mm
ON 4	E	4st phase on	24:00	00:00...23:59	hh:mm
OF 4	E	4st phase off	24:00	00:00...23:59	hh:mm
TSPHW					
ON 1	E	1st phase on	06:00	00:00...23:59	hh:mm
OF 1	E	1st phase off	22:00	00:00...23:59	hh:mm
ON 2	E	2st phase on	24:00	00:00...23:59	hh:mm
OF 2	E	2st phase off	24:00	00:00...23:59	hh:mm
ON 3	E	3st phase on	24:00	00:00...23:59	hh:mm
OF 3	E	3st phase off	24:00	00:00...23:59	hh:mm
ON 4	E	4st phase on	24:00	00:00...23:59	hh:mm
OF 4	E	4st phase off	24:00	00:00...23:59	hh:mm
HEAT					
COMFR	E	Comfort setpoint	20	5...35	°C
ECONM	E	Reduced setpoint	18	5...35	°C
NOFRS	E	Frost protection setpoint	5	5...35	°C
HC SL	O	Flow temp setpoint manual	80	20...80	°C
HC MX	F	Flow temp setpoint max OEM	80	20...80	°C
HC MN	F	Flow temp setpoint min	20	20...80	°C
SLOPE	F	Heating curve slope	1,5	0,1...4	
SUWI	F	Summer/winter heating limit	18	8...30	°C

Continued on next page...

Continued from previous page...

Operating line	Operating level	Function	Factory setting	Range	Unit
ECO24	F	24-hour heating limit	0	-10...+10	°C
KORR	F	Room influence	4	0...20	
BUILD	F	Time constant building	3	0...10	
AMBON	F	Room influence ON/OFF 0 = OFF, 1 = ON	1	0-1	
QSETB	F	Quick setback ON/OFF 0 = OFF, 1 = ON	1	0-1	
SDR	F	Room temp limitation	0,5	0,5...4,0	°C
HC2SR 2)	F	Room temperature setpoint for heating circuit 2	20	5...35	°C
HC2SF 2)	F	Flow temperature setpoint heating circuit 2	80	20...80	°C
COOL 1)					
COMFR	E	Comfort setpoint	22	5...30	°C
ECONM	E	Reduced setpoint	24	5...30	°C
DHW					
COMFR	F	Nominal setpoint	55	35...70	°C
ECONM	F	Reduced setpoint	35	35...70	°C
SHOWR	O	Shower function setpoint	40	35...70	°C
HW MX	F	DHW setpoint max	65	35...70	°C
HW MN	F	DHW setpoint min	35	35...70	°C
L FCT	F	Legionella function 0 = OFF, 1 = ON	0	0...2	
L TIME	F	Legionella function dwelling time	1	1...180	Min
L TEMP	F	Setpoint of legionella function	65	35...70	°C
CONF					
HW PR	F	DHW program	1	0...2	
COOL	F	COOLING ON/OFF 0 = OFF, 1 = ON	0	0-1	
RESET	O	Reset to default parameters 0 = NO, 1 = YES	0	0-1	

1) This menu is only visible if parameter COOL is ON

2) Only active when supported by BMU

The above table shows all available settings up to the heating engineer level. However, certain operating lines may be hidden, depending on the type of unit.
E = End user, F = Heating engineer, O = OEM

4.0 Operation



	Operating element	Function
①	Heating circuit operating mode button and associated symbols	Operating mode changes to: Automatic operation Continuous operation Protection Temporary function
②	D.h.w. operating mode button with associated symbol	D.h.w. heating ON / OFF
③	Setpoint buttons Heating	Adjustment of room temperature setpoint
④	Setpoint buttons D.H.W.	Adjustment of D.H.W. temperature setpoint
⑤	Info button	Change of info display
⑥	Occupancy button	Changeover of operating level
⑦	LCD	Display of data and operating mode

	DHW mode ON
	Boiler operation for DHW heat demand
	Maintenance message
	Holiday function
	Heating to Comfort setpoint
	Heating to Reduced setpoint
	Boiler on

	Space heating mode ON
	Boiler operation for heating circuit heat demand
	Automatic operation
	Temporary function
	Continuous operation
	Protection

4.1 Display:

Please see the previous table for the descriptions of the individual display icons.

Display

Display of all symbols and segments.

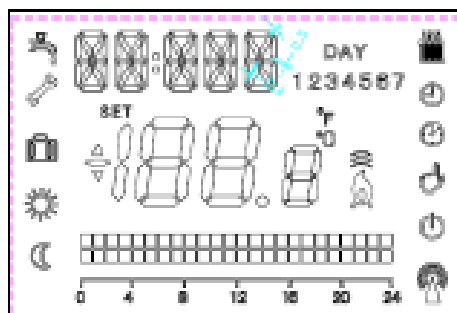

Selection of space heating mode

This setting is used to switch between the different operating modes. The selection made is indicated by a bar which appears below the respective symbol.

Automatic mode

Automatic mode controls the room temperature according to the time program.

Characteristics of automatic mode:

- Heating mode according to the time program
- Temperature setpoints according to the heating program "Comfort setpoint" or "Reduced setpoint"
- Protective functions active
- Automatic summer / winter changeover and automatic 24-hour heating limit (ECO functions) active

Continuous operation

Continuous operation maintains the room temperature at the selected operating level.

Characteristics of continuous operation:

- Heating mode with no time program
- Protective functions active
- Automatic summer / winter changeover and 24-hour heating limit (ECO functions)

inactive in the case of continuous operation with Comfort setpoint

Protection

When using Protection mode, the heating system is off, but it remains protected against frost (frost protection temperature) provided there is no power failure.

Characteristics of Protection:

- Heating off
- Temperature according to frost protection
- Protective functions active
- Automatic 24-hour heating limit (ECO functions) active

Cooling mode (if activated)

Cooling mode controls the room temperature in accordance with the time program.

Characteristics of cooling mode:

- Manual cooling mode
- Cooling mode based on time program
- Temperature setpoint based on "Comfort setpoint" or "Reduced setpoint"

Selecting the DHW heating mode



The button is used to switch DHW heating mode on and off.

DHW heating mode

- On
The DHW is heated according to the selected switching program. A setpoint is generated based on the demand for heat and the settings and passed on to the BMU.
- Off
No DHW heating

DHW shower

This function allows to set a temporary setpoint.
Triggering is effected by keeping the DHW operating mode button for at least 3 seconds.
The setpoint remains active during 55 minutes -> tap symbol is blinking.

Notes

- To deactivate the function before the end of the 55 min press DHW button
- The d.h.w. operating mode and the different d.h.w. functions are active only if supported by boiler control and if communicated in OpenTherm Plus mode



Caution

The QAA73.110 has no frost protection function for d.h.w. heating. Frost protection for d.h.w. must be ensured by boiler control.

Adjusting the room temperature setpoint "tAMB"

- / +



Push the + /- buttons to increase or decrease the **Comfort** setpoint.
The **Reduced** setpoint can be adjusted in programming level.

Adjusting the DHW temperature setpoint "HW SP"

- / +



Push the + /- buttons to increase or decrease the **Nominal** setpoint.
The **Reduced** setpoint can be adjusted in programming level.

Presence button



If you do not use the rooms for a certain period of time, you can press the presence button to reduce the room temperature, thus saving heating energy.
When the rooms are occupied again, press again the presence button to resume heating operation.

- The presence button is only active in automatic operation
- The current selection is active until the next switching action according to the heating program takes place

During the holiday period, the heating circuit operating level changes to frost protection.



The setting range is between 10 minutes and 45 days.

- This function is only active in automatic mode.
- The function can be cancelled by pressing any button

Displaying information

i

Various data can be displayed by pressing the info button. Depending on the type of unit, configuration and operating state, some of the info lines listed below may not appear.

Display:

Description	Name	Unit
- Boiler temperature	BOILR	°C
- Water pressure	P BAR	Bar
- Outside temperature	EXT T	°C
- Domestic hot water temperature	DHW	°C
- Domestic hot water temperature 2	DHW 2	°C
- Domestic hot water flow rate	DHWFR	l/min
- Relative boiler power	PWR	%
- Fan speed	S FAN	Rpm
- Exhaust temperature	T EXH	°C
- Return temperature	RETUR	°C
- Calculated flow temperature setpoint	CH SP	°C

During boiler operation it is possible to see the actual boiler modulation level on 4 different levels.

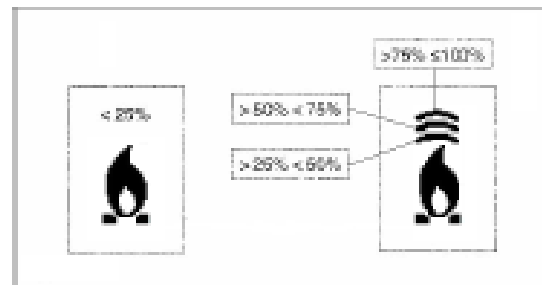

Indication of faults

The room unit indicates faults that may have occurred in the unit itself or in the system

If a fault is indicated 'ERROR' and the error code followed by the letter 'E' are visualized in the display.

These faults cannot be reset. They will be cleared only when rectified.

Error code	Description
60	Room sensor
88	Communication
95	Clock
127	Legionella setpoint not reached 1)

1) Can be reset by pressing OK button

Other fault displays

Depending on the type of boiler control, the room unit also displays other error codes. For detailed information, please refer to the technical documentation of the boiler controller used.

Boiler lockout

During boiler lockout, 'ERROR'.and '>>>OK' are blinking alternatively and the error code followed by the letter 'E' are visualized in the display.



For resetting the BMU press the OK button
If the reset was successful 'RESET' followed by '>>>OK' are visualized in the display.



Chimney sweep





Is activated / deactivated on the BMU
Boiler temperature is visualized on the QAA

Controller stop

Is activated / deactivated on the BMU
Modulation level can be set by up down buttons

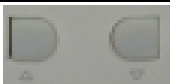
4.2 Programming BMU Parameters

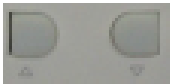
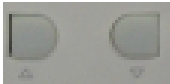
This functionality is available only on some BMU's.

	Buttons	Explanation
1		Press the line selection buttons for at least 3 seconds. This will take you directly to the programming level "Enduser".
2		The display shows a number of operating pages. Press the line selection buttons to select the required operating page. To confirm, press OK.
3		The display shows a number of operating pages. Press the line selection buttons to select the required operating line. To confirm, press OK.
4		The display shows the value flashing. Press the line selection buttons until value is correct. To confirm, press OK.
5		By pressing the ESC button, you come back to operating page selection.
6		By pressing the ESC button, you leave the programming level.

If no button is pressed for about 1 minutes, the room unit will automatically leave programming level.

The user levels only allow authorized user groups to make settings. To reach the required user level, proceed as follows:

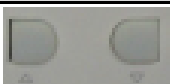
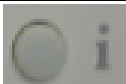
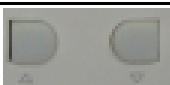
	Buttons	Explanation
1		Press the line selection buttons for at least 3 seconds. This will take you directly to the programming level "Enduser".
2		Press the Info button for at least 3 seconds. This will take you to the user level selection.
3		You are now given a choice of user levels. Press the line selection buttons to select the required user level. To confirm, press OK. You are now on the required user level.

The following user levels are available

- USR = End user
- INST = Heating engineer
- OEM = OEM

To reach the OEM level, the relevant code must be entered.

For detailed information, please refer to the technical documentation of the boiler controller used.

4.3 Description of room unit settings

4.3.1 Time & day (Time)

To ensure proper functioning of the heating program, the time switch with the time of day and the weekday must be correctly set.

Time of day and weekday are important, ensuring that the heating program, the cooling program and the d.h.w. program operate as required.

4.4 Time switch program (TSPHC, TSPCC, TSPHW)

4.4.1 Day Selection

With this setting, you select the weekdays or the day block for which the switching times of the time switch program apply.

- This setting must be made before the switching times are entered!
- For every day on which other switching times shall apply, the pre-selection of the individual day with subsequent entry of the switching times must be repeated

Entry of the 7 day block:

Entry of the switching times on lines 'ON 1' through 'OFF 4' is identical for every day from Monday through to Sunday .

Example of a time switch program valid for all weekdays

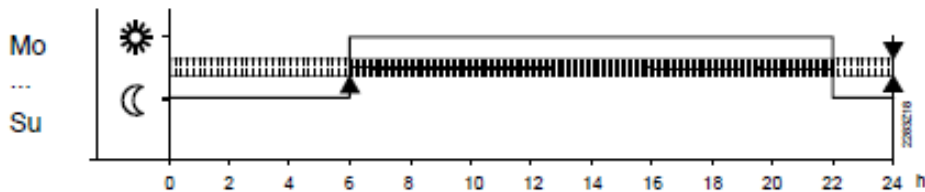

Entry of individual days:

Entry of the switching times on lines 'ON 1' through 'OF 4', are only entered for the individual day selected here

Example of a 7-day time switch program:

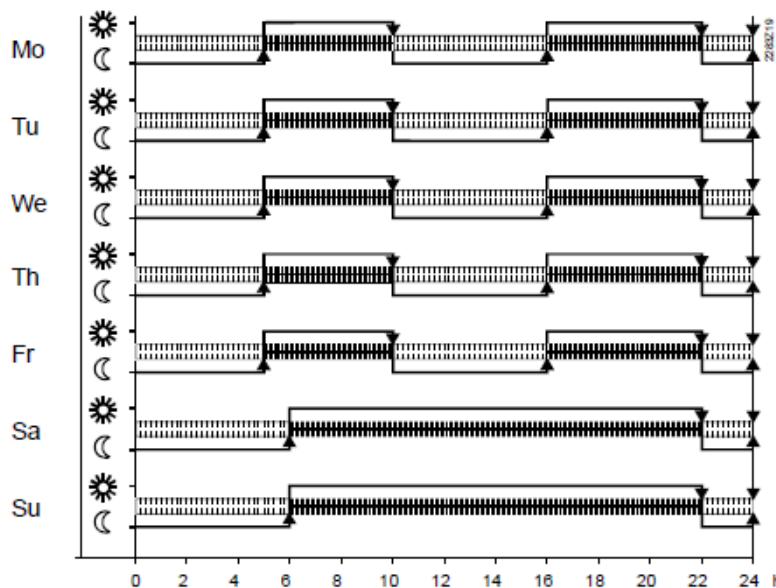

Tip: First, choose enter the switch- the majority of individual days to adjustments.

the 7-day block to ing times required for days; then, select the make the required

4.4.2 Switching Times

This setting defines the switching times for space heating and d.h.w. heating. The temperature setpoints of the 2 heating circuits and the d.h.w. usage times change at the times set.

Note: First, select the weekday for which the switching times shall be entered!

4.5 Heating Circuit (HEAT)

In comfort operation, the comfort room temperature setpoint is maintained.

The comfort room temperature setpoint is adjusted with the buttons for the comfort temperature, which are located on the controller front for direct access by the user. When a button is pressed, the current room temperature setpoint is displayed and when pressed further – readjusted.

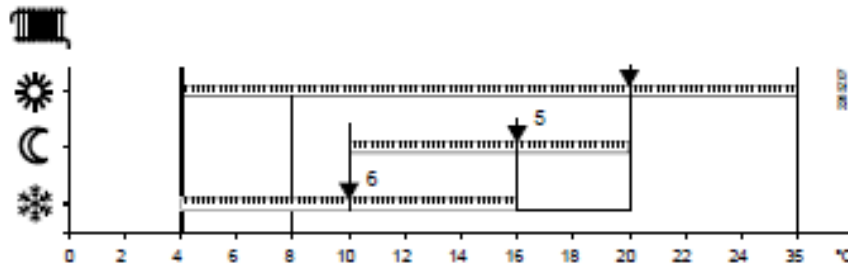

Room temperature ranges:

setpoint setting

- 5 Reduced room temperature setpoint (ECONM)
- 6 Frost protection setpoint of the room temperature (NOFRS)

When the comfort room temperature setpoint is active, the rooms will be heated according to the adjustment made with the setpoint buttons.

The adjustment made with the buttons is only active in automatic and continuous operation.

The comfort phases depend on the settings made on lines 'ON 1' through 'OF 4'.

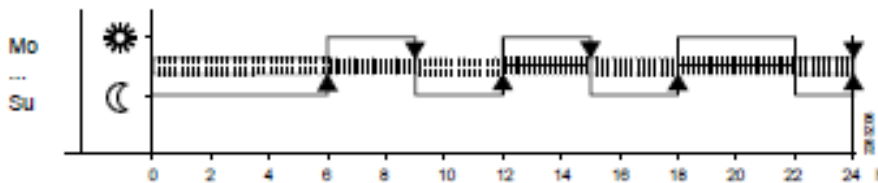

Comfort temperature and reduced temperature phases for heating circuit.

The reduced room temperature setpoint (ECONM) ensures a lower room temperature during the night, for instance, to save energy.

It is not possible to set the reduced setpoint above the adjustment made on comfort room temperature setpoint. During the reduced phases, the reduced room temperature setpoint is maintained. Any lower comfort temperature is given priority however.

The frost protection room temperature setpoint (NOFRS) function prevents the room temperature from falling below the adjusted frost protection setpoint.

This setting will change the frost protection setpoint of the room temperature.

- This function is ensured only when the heating plant operates properly!
- Frost protection for the boiler and the d.h.w. must be ensured by the boiler control

Minimum and maximum limitation define the range within which the flow temperature setpoint may vary. They prevent too low or too high flow temperatures.

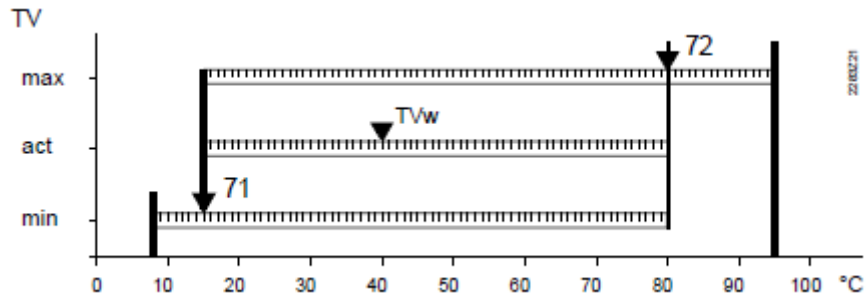

TVw Current flow temperature setpoint.

temperature set-

- 71 minimum limitation of flow temperature (CH MN)
- 72 maximum limitation of flow temperature (CH MX)

These settings provide maximum or minimum limitation of the flow temperature.

Note: Maximum limitation is NOT to be regarded as a safety function as required with underfloor heating systems, for example.

Heating curve slope (SLOPE) . The room unit generates the flow temperature setpoint based on the selected heating curve. The result is a constant room temperature irrespective of outside temperature variations.

By changing the setting, the slope of the heating curve will be increased or decreased with the following effects:

Increase: The flow temperature will be raised when the outside temperature drops

Decrease: The flow temperature will be raised less when the outside temperature drops

The following settings produce the following effects:

- 2.5...40.0 The room unit delivers a weather-compensated flow temperature for the respective heating circuit
- .- The relevant heating circuit is deactivated

Note:

The programmed heating curve is based on a room setpoint of 20°C. If the room setpoint is adjusted, the heating curve automatically adapts to the new value.

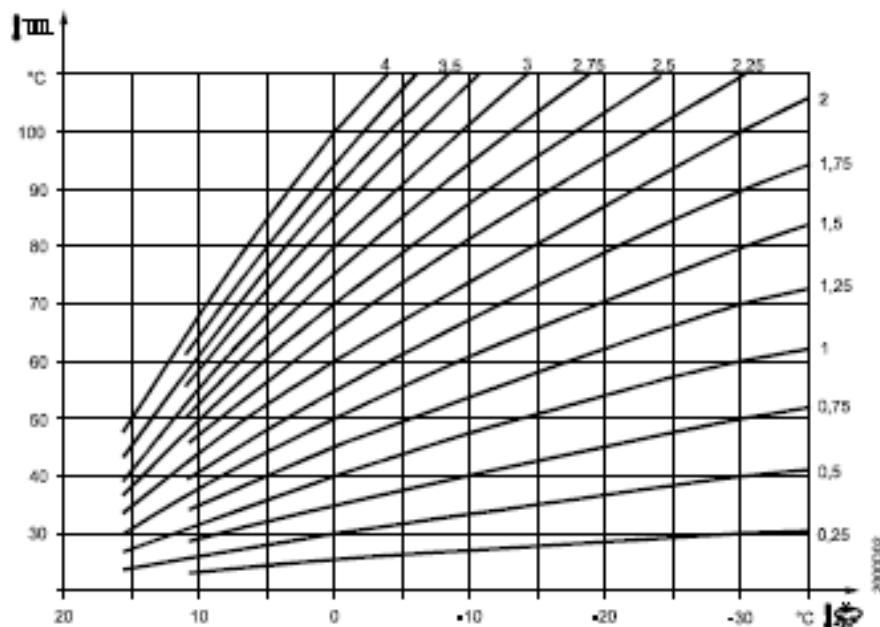

Summer / winter changeover temperature (SUWI) :

The summer / winter changeover temperature is the criterion for automatic summer / winter changeover of the heating plant.

It offers the following benefits:

- Fully automatic operation throughout the year
- The heating will not be switched on when the outside temperature drops for short periods of time
- Additional savings function

By changing the setting, the respective periods of time will be shortened or extended. The change will only affect the heating circuit.

Increase: Winter operation will start *earlier* Summer operation will start *later* .

Decrease: Winter operation will start *later* Summer operation will start *earlier*

To determine changeover, the setting of the summer / winter changeover temperature (± a fixed switching differential) is compared with the attenuated outside temperature.

Heating OFF (from winter to summer)	$T_{aged} > SuWi + 1 \text{ } ^\circ\text{C}$
Heating ON (from summer to winter)	$T_{aged} < SuWi - 1 \text{ } ^\circ\text{C}$

Note: This function only acts in automatic mode.

This func-

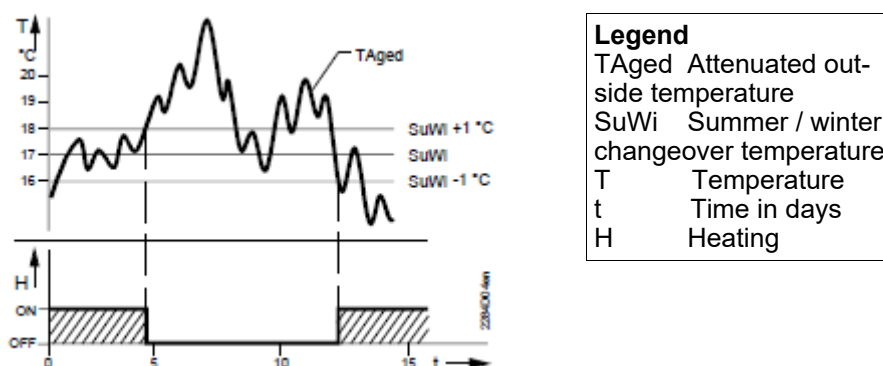

The 24-hour heating limit is used to switch the heating on and off in the course of the day, depending on the outside temperature. This function is used primarily during spring and autumn to respond to short-term temperature variations.

Example:

Setting line	e.g.
Comfort setpoint (TRw)	22 °C
24-hour heating limit (THG)	-3 °C
Changeover temperature (TRw-THG) heating off	= 19 °C
Switching differential (fixed)	-1 °C
Changeover temperature heating on	= 18 °C

By changing the value entered, the respective heating periods will be shortened or extended.

Increase: Heating mode will start *earlier*, changeover to ECO *later*.

Decrease: Heating mode will start *later*, changeover to ECO *earlier*.

Note:

- The function is not active in operating mode "Continuously Comfort temperature"
- To give consideration to the building's thermal dynamics, the outside temperature will be attenuated



Gain factor of room influence (KORR):

Defines the influence of room temperature setpoint deviations on the controlled system. The room influence can be activated and deactivated (operating line 75).

Changing this setting has the following impact:

- Increase: Authority of room influence will increase
- Decrease: Authority of room influence will decrease

The following example shows how and according to which formula the room temperature setpoint will be corrected.

Room temperature setpoint :
TRw = Actual room temperature
TRx = 22°C
Correction factor KORR = 8

$$TRwk = TRw + KORR/2 (TRw - TRx) \quad TRwk = 20 \text{ °C} + 4 (20 \text{ °C} - 22 \text{ °C}) = 12 \text{ °C}$$

KORR Constant for room influence
TRx Actual value of the room temperature
TRw Room temperature setpoint
TRwk Room temperature setpoint (readjusted)

As the example shows, if the room temperature is 2 °C too high, the room influence temporarily shifts the room temperature setpoint down to a level of 12 °C.

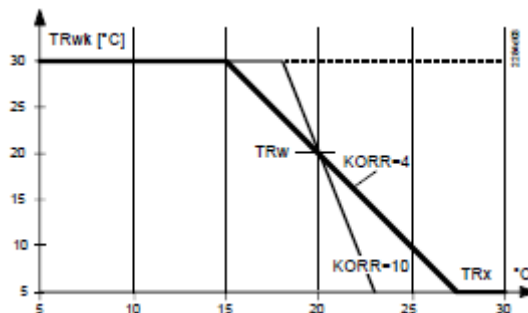

Note: KORR works only if vated.

the room temperature influence is acti-

Type of building construction (BUILD):

Enables the control system's rate of response to be matched to the type of building construction.

When the outside temperature varies, the room temperature changes at different rates, depending on the building's thermal storage capacity. The above setting ensures that the generation of the composite outside temperature will be matched to the type of building construction. Also refer to "Composite outside temperature".

5...10 Heavy building structures:

The room temperature will respond slower to outside temperature variations

1...5 Light building structures:

The room temperature will respond quicker to outside temperature variations

Room Influence (AMBON):

Owing to the temperature checkback signal received from the room, a constant room temperature is maintained and, if required, quick setback enabled.

Room temperature deviation is the temperature differential between actual room temperature and room temperature setpoint.

The setting will activate the room influence on the heating circuit.

Deviations of the actual room temperature from the setpoint are acquired and taken into account by temperature control.

To be able to use the control variant "Weather compensation with room influence", the following conditions must be satisfied:

- An **outside sensor** must be connected to boiler control
- Room influence **must** be enabled to act on the relevant heating circuits
- There may be **no thermostatic radiator valves** in the reference room (If such valves are present, they must be set to their fully open position).

Quick Setback (QSETB):

During quick setback, the heating circuit pump is deactivated.

Function with room sensor:

When using the room sensor, the function keeps the heating switched off until the room temperature has dropped to the level of the reduced setpoint or the frost level.

When the room temperature has fallen to the reduced level or the frost level, the heating circuit pump will be activated and the mixing valve will be released.

Function without room sensor:

Quick setback switches the heating off for a certain period of time, depending on the outside temperature and the building time constant.

Example

Duration of quick setback when Comfort setpoint minus Reduced setpoint = 2 °C
(e.g. Comfort setpoint = 20 °C and Reduced setpoint = 18 °C)

Outside temperature composite:	Building time constant:						
	0	2	5	10	15	20	50
15 °C	0	3.1	7.7	15.3	23	30.6	76.6
10 °C	0	1.3	3.3	6.7	10	13.4	33.5
5 °C	0	0.9	2.1	4.3	6.4	8.6	21.5
0 °C	0	0.6	1.6	3.2	4.7	6.3	15.8
-5 °C	0	0.5	1.3	2.5	3.8	5.0	12.5
-10 °C	0	0.4	1.0	2.1	3.1	4.1	10.3
-15 °C	0	0.4	0.9	1.8	2.6	3.5	8.8
-20 °C	0	0.3	0.8	1.5	2.3	3.1	7.7
Duration of quick setback in hours							



- T Quick setback is possible with or without a room sensor

Room temperature maximum limitation (SDR):

It is used for room temperature limitation. This function prevent rooms from getting overheated.

The switching differential for 2-position control will be changed.

- . -- Switching differential is inactive
 - The pump always remains activated

- Decrease: Switching differential will become smaller
 - The pumps are switched on and off more often
 - The room temperature varies within a narrower band

- Increase: Switching differential will become greater
 - The pumps are switched on and off less often
 - The room temperature varies within a wider band

With pump heating circuits, the amount of heat supplied is controlled by switching the pumps on and off. This is accomplished with 2-position control by means of the room temperature's switching differential.

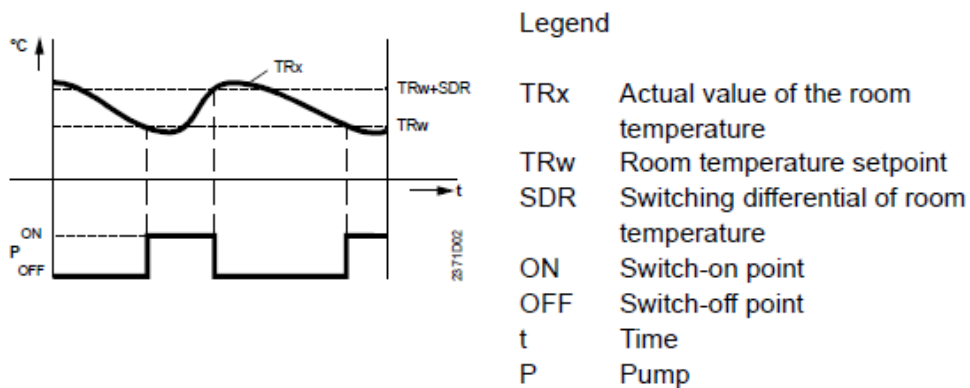

Pump ON
 $TRx = TRw$
 Pump OFF
 $TRx = TRw + SDR$

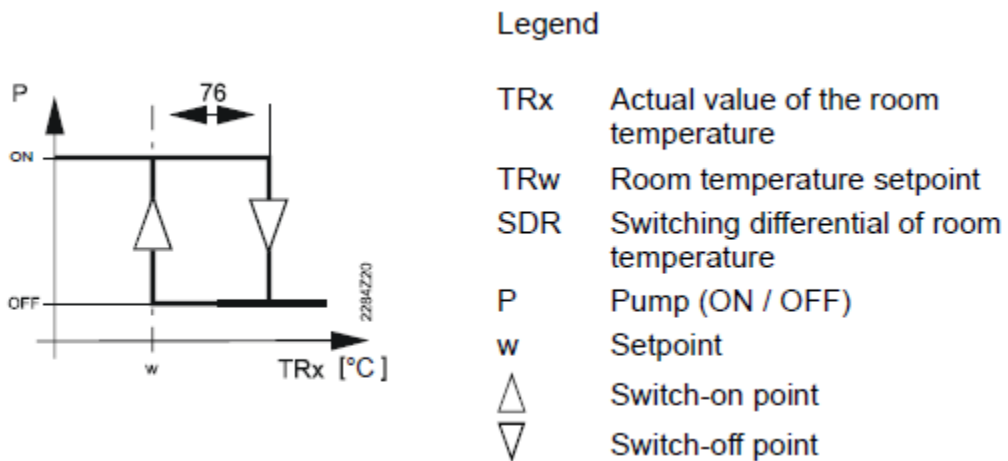

Note: The heating circuit pumps are controlled not directly by the QAA73.110, but by boiler control. For this reason, this functionality is not ensured by the room unit alone.

(HC2SR) Room temperature setpoint for heating circuit 2. Active only if supported by BMU.

(HC2SF) Flow temperature setpoint for heating circuit 2. Active only if supported by BMU.

4.5 Cooling Circuit (COOL):

Comfort room temperature setpoint (COMFR)

In comfort operation, the comfort room temperature setpoint is maintained.

The comfort room temperature setpoint is adjusted with the buttons for the comfort temperature, which are located on the controller front for direct access by the user.

When a button is pressed, the current room temperature setpoint is displayed and – when pressed further – readjusted.

Reduced room temperature setpoint (ECONM)

The reduced room temperature setpoint ensures a higher room temperature during the night, for instance, to save energy.

4.6 Domestic Hot Water (DHW)

Nominal DHW temperature setpoint (COMFR)

During nominal operation, the nominal d.h.w. setpoint is maintained. It is possible to use 2 different d.h.w. temperature setpoints.

The temperature setpoint during normal d.h.w. operation will be changed.

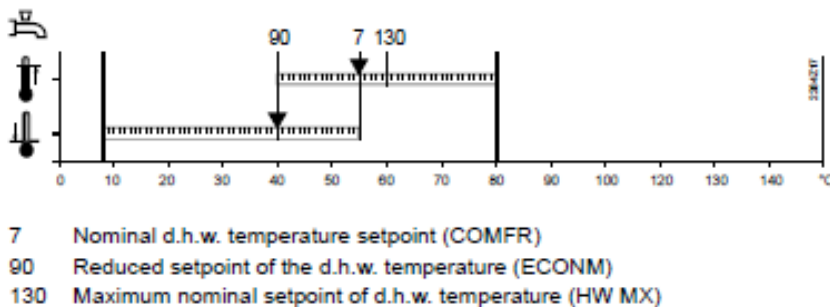

Reduced DHW temperature setpoint (ECONM)

Reduction of the d.h.w. temperatures outside main occupancy times. The time switch integrated in the room unit automatically switches between main and secondary occupancy times.

D.h.w. is at a high temperature level only if required. This saves energy by reducing the temperature when not in use.

The temperature setpoint during reduced d.h.w. operation will be changed

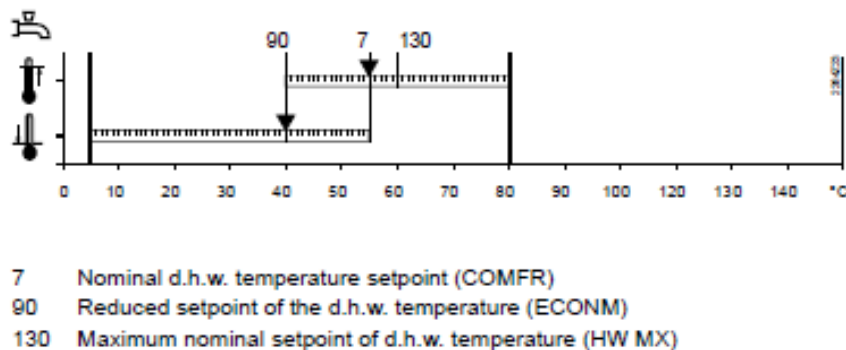

Maximum setpoint (HW MX):

DHW temperature

Function for limiting the maximum settable nominal setpoint of the d.h.w. temperature.

Note: A d.h.w. setpoint maximum (TBWmax) of a BMU transmitted via OpenTherm is given priority and replaces that of the room unit (setting 130).

Minimum DHW temperature setpoint (HW MN):

Function for limiting the minimum settable nominal setpoint of the d.h.w. temperature.

Note: A d.h.w. setpoint minimum (TBWmin) of a BMU transmitted via OpenTherm is given priority and replaces that of the room unit (setting 130).

Legionella function (L FCT):

The legionella function ensures that the d.h.w. in the storage tank will periodically be raised to a temperature higher than nominal setpoint.

The setting activates or deactivates the legionella function. Entry:

OFF Function inactive

Weekly ON: Function is activated every Monday morning when d.h.w. is heated up for the first time and lasts a maximum of 2.5 hours. The d.h.w. is heated up to the adjusted legionella setpoint.

Daily Function is activated every day when d.h.w. is heated up for the first time and lasts a maximum of 2.5 hours. The d.h.w. is heated up to the adjusted legionella setpoint.

Notes:

- If on the starting day of the legionella function, d.h.w. is not heated, or if the function is aborted, it will be repeated the next day when d.h.w. is heated for the first time.
- This function is possible only when d.h.w. heating is released by the d.h.w. heating program.

Dwelling time at legionella function setpoint (L TIME):

The setpoint of the legionella function (operating line 92) is maintained for at least the period of time set here.

--- Function deactivated (no dwelling time)

The dwelling time starts as soon as the legionella setpoint is reached.

During the entire dwelling time, the temperature may not fall below the legionella setpoint by more than the set BMU d.h.w. switching differential. The legionella function is terminated when this criterion is met.

Setpoint of the legionella function (L TEMP):

The setpoint of the legionella function is an adjustable temperature level to which the d.h.w. temperature is raised when the legionella function is activated.

The setting changes the d.h.w. setpoint during the period of time the d.h.w. is heated up as a result of the legionella function.

4.7 Configuration (CONF)

TSP DHW enable (HW PR)

The setting activates or deactivates time switch program.

0: DHW OFF

1: DHW always ON

2: DHW time switch program active

Cooling enable (COOL)

The setting activates or deactivates the cooling function

Default parameters (RESET)

All parameters can be reset to their default values.

4.8 Functions

Introduction

The functions described below require no settings. They are performed automatically but have an impact on the plant.

For the rectification of faults, planning and plant maintenance, it may therefore be very advantageous to know about their impact on plant operation.

Types of compensation:

The room unit offers 3 types of compensation each of which generates the effective flow temperature setpoint in a different way. They are the following:

- Weather compensation
- Weather compensation with room influence
- Room compensation
- Fix flow temperature setpoint

4.8.1 Weather compensation

With this type of compensation, the building's heat losses are compensated by an adequate flow temperature.

The colder the weather, the quicker the building cools down and the greater the heating circuit's heat demand.

With this type of compensation, it must be ensured that the heating curve is correctly set, because the room unit gets no feedback from the space whether the amount of heat supplied meets the demand of the users.

Note: The room influence (AMBON) must be set to "OFF" and, in addition, an outside sensor must be connected.

4.8.2 Weather compensation with room influence

Compared to pure weather compensation, this type of compensation offers enhanced comfort because with the room influence, the room unit gets a feedback from the space.

Note: The room influence (AMBON) must be activated for the required heating circuits and, in addition, an outside sensor must be connected.

Room influence:

The room influence acts on the room temperature setpoint. The deviation of setpoint / actual value of the room temperature is multiplied by the correction factor KORR/2 and added to the deviation from the room temperature setpoint in the opposite direction.

Room influence acts:

- In the case of deviations of setpoint / actual value of the room temperature
- With automatic or manual changeover to a higher or lower room temperature setpoint

4.8.3 Room Compensation

With pure room compensation, a PID control algorithm is activated. This is the preferred control mode if the room temperature is the only compensating variable available. The selected control algorithm gives consideration to both the actual value of the room temperature and the current slope (gradient). The P-part is generated by the control deviation, the D-part from the gradient of the room temperature. The I-part suppresses continuous deviations of setpoint / actual value.

Note: The room influence (AMBON) must be activated for the required heating circuits and, in addition, no outside sensor may be connected.

The flow temperature and thus the room temperature are controlled as a function of the actual room temperature and its current development. For example, if the room temperature rises slightly, the flow temperature will immediately be reduced even if there is deviation of setpoint / actual value apparent yet. To prevent continuous deviations, the I-part of PID control keeps the room temperature at the required level.

4.8.4 Fix flow temperature setpoint:

The setpoint has to be set manually.

Note: The room influence (AMBON) must be set to "OFF" and, in addition, no outside sensor may be connected.

5.0 Operational fault finding

No display on the room unit:

- Is the heating plant's main switch turned on?
- Are the fuses in order?
- Check the wiring

Room unit displays a wrong time of day or a wrong date:

- Set the right time of day, the right date and the year on the room unit if the QAA73.210 is the clock master
- Set the correct time of day and the date on the clock master (if present)

Boiler control does not switch on

- Does boiler control really have to operate?
- Press boiler control's lock-out reset button
- Check the control thermostat (TR) and the manual reset safety limit thermostat (STB)
- Check wiring and fuse of boiler control
- Check the communication link to boiler control

The room temperature does not agree with the required temperature level:

- Does the room temperature setpoint agree with the required temperature level?
- Is the required operating mode indicated?
- Are weekday, time of day and the displayed heating program correct? (Info displays)
- Has the heating curve slope been correctly set?
- Check wiring of outside sensor
- Has the "Nominal room temperature setpoint" with the "Parallel displacement of the heating curve" been calibrated based on the effective room temperature?
- Check boiler control

D.h.w. is not being heated:

- Has the button for d.h.w. heating been pressed?
- Check setpoint of the d.h.w. temperature
- Check d.h.w. function of boiler control

6.0 Technical Data

OpenTherm Interface:

Terminals	2-wire (interchangeable)
Cable length	max. 50m
Cable resistance	max. 2 x 5Ω
Power consumption	20mW (typically)

Safety class	III to EN 60 730 when mounted in compliance with regulations
--------------	---

Degree of Protection	IP 20 to EN 60529
----------------------	-------------------

Contamination	Environment to EN 60730
---------------	-------------------------

Operation	EN 60721-3-3 Class 3K 5
• Temperatures	0...50°C
• Humidity	< 85 % r.h.

Transport	EN 60721-3-2 Class 2K 3
• Temperatures	-25... 70°C
• Humidity	< 95 % r.h.

Storage	EN 60721-3-1 Class 1K 3
• Temperatures	-20... 70°C
• Humidity	< 95 % r.h.

CE Conformity

EMC directive	2004/108/EC
-Immunity	EN 60730-1
-Emissions	EN 60730-1
Reduction of Hazardous substances	2002/95/EC

Measuring Range	0... 50°C
According to EN12098:	
Range 15...25°C	within tol. Of 1.3K
Range 0...15°C or 25...50°C	within tol. Of 1.6K
Resolution	1/10K

Back-up of Time Switch	min. 12h
Software Class	A to EN 60 730
Weight	approx 0.115kg

7.0 Single Heating Zone Installations

Description of system type

All heating circuit pumps and temperature control is achieved via the boiler with the QAA73 room controller. Time clock and climate settings are programmed within the QAA73 room controller as part of the commissioning procedure.

Hardware required

- 1 Boiler incorporating LMU64 boiler management unit.
- 2 Room programmer QAA73. Programmable room unit kit including wiring terminal blocks for boiler LMU wiring connection, part number 563605337.
- 3 External air sensor QAC34. Part number 533901457.

Frost protection

The building is protected for internal temperature using the QAA73 room programmer temperature sensor.

The boiler is internally protected for water temperature using the LMU64 temperature sensors.

Heating pump

The heating pump is designated Q1. This must be connected to the boiler at terminals 'X2-02, Q1 heating circuit pump contactor'.

Flow rate and resistance for the heating pump must be sized in accordance with the flow requirements for the boiler and the resistance requirements of both the boiler and the heating circuit.

Note: The control does not incorporate a facility for switching duty/standby pumps. If required this must be facilitated externally to these controls.

Room programmer

The single room programmer, QAA73, must be installed in the location most suitable for providing accurate space heating comfort control with the first heating circuit area (circuit using pump Q1). This must be connected to the boiler at terminals 'X10-01, room unit QAA73'.

Wiring should be completed using a 1.5mm² twisted pair shielded cable run separately to any mains cables to prevent electrical interference.

External air sensor

This must be installed on a North facing wall to prevent solar heating of the sensor and away from

heat emitting items such as ventilation outlets. Connection is directly to the boiler at terminals 'X10-06, external air sensor QAC34'. Wiring should be completed using a 1.5mm² twisted pair shielded cable, run separately to any mains cables to prevent electrical interference. For further details regarding the sensor specification and fitting requirements refer to appendix A at the rear of this manual.

Features available with this system

- 7 Day time clock with 4 periods each day
- Auto summer/winter time change (BST to GMT)
- Holiday program
- Frost protection for building
- Reduced temperature (night setback)
- Weather compensation
- Summer shutdown
- Fault diagnostics with error code indication
- Programmable lock to prevent tampering after commissioning

PIPEWORK AND CONTROLS SCHEME FOR SINGLE BOILER APPLICATION WITH SINGLE HEATING CIRCUIT

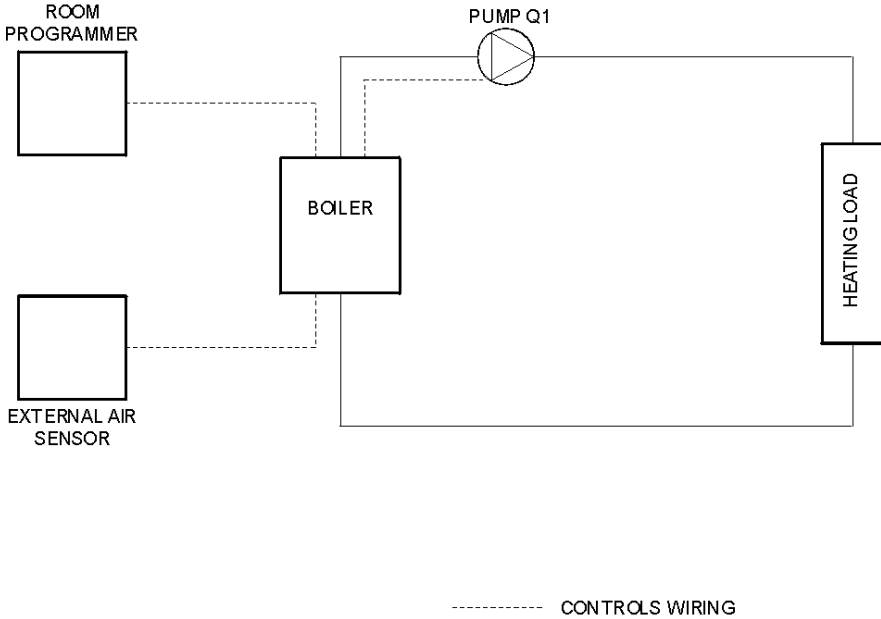

TO BE READ IN CONJUNCTION WITH WIRING SCHEMATIC

1131/PS5/A

BOILER WIRING SCHEMATIC FOR SINGLE BOILER APPLICATIONS WITH SINGLE HEATING CIRCUIT

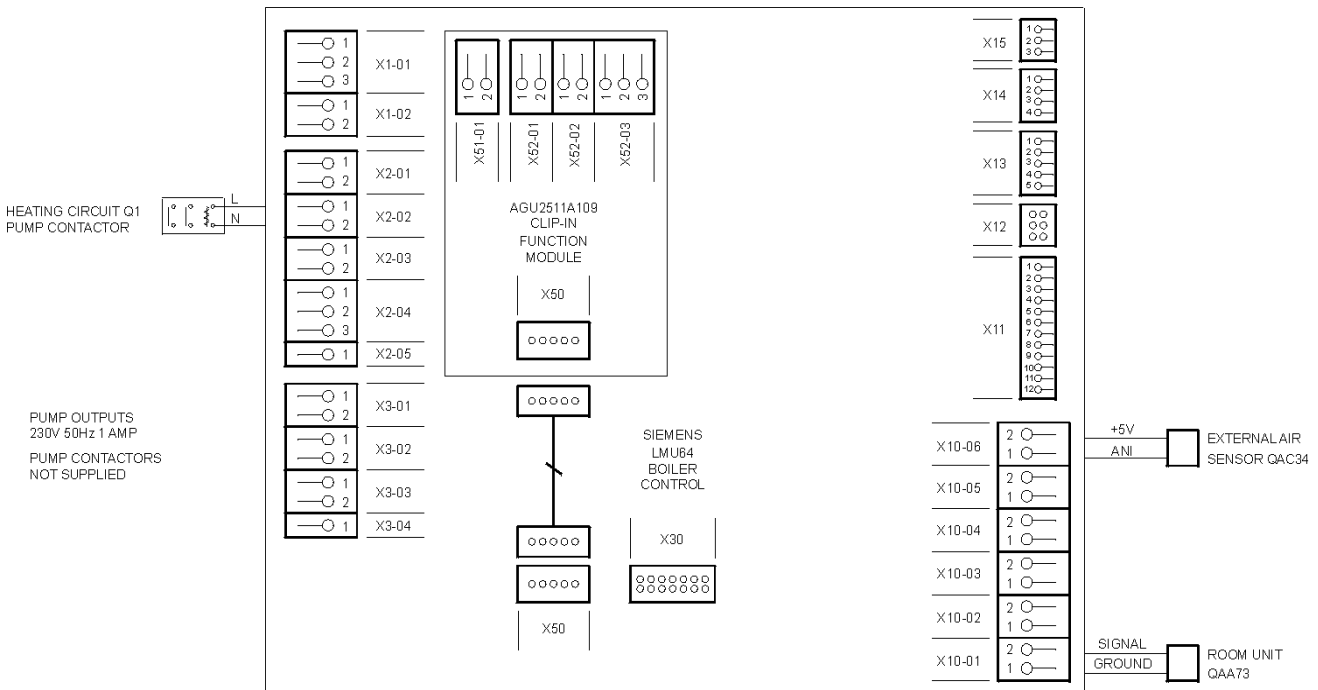

ALL EXISTING WIRING NOT SHOWN FOR CLARITY. REFER TO BOILER INSTALLATION MANUAL FOR BOILER WIRING DETAIL. INTERCONNECTING WIRING NOT SUPPLIED. SIGNAL CABLES MUST BE RUN IN SEPARATE CONDUITS TO MAINS CABLES.

1131/WS5/A

8.0 Single Heating Circuit with Domestic Hot Water

Description of system type

All circuit pumps and temperature control is achieved via the boiler with the QAA73 room controller. Time clock and climate settings are programmed within the QAA73 room controller as part of the commissioning procedure.

The boiler controller, LMU64, will set the primary temperature according to the highest heat requirement, ie, if the D.H.W. cylinder requires a higher temperature than the heating circuit the primary temperature will be set to this. During this period the heating circuit pump will be switched off to prevent overheating of the space.

Hardware required

- 1 Boiler incorporating LMU64 boiler management unit.
- 2 Room programmer QAA73. Programmable room unit kit including wiring terminal blocks for boiler LMU wiring connection, part number 563605337.
- 3 External air sensor QAC34. Part number 533901457.
- 4 D.H.W. Cylinder sensor QAZ21. Sensor kit including wiring terminal blocks for boiler LMU wiring connection and immersion pocket, part number 563605338.

Frost protection

The building is protected for internal temperature using the QAA73 room programmer temperature sensor.

The boiler is internally protected for water temperature using the LMU64 temperature sensors. Also the D.H.W. cylinder is protected via the signal received from the cylinder sensor. Both boiler and hot water cylinder frost protection settings are pre-programmed in the boiler controls, not the QAA73 programmable room unit.

Primary circuit pump

The primary circuit pump is designated Q8. this must be connected to the boiler at terminals 'X2-03, Q8 primary circuit pump contactor'. The control signal is a start stop control that must be wired via suitable contactors and hand/auto switches for maintenance purposes.

Flow rate and resistance for the primary pump must be sized in accordance with the flow requirements for the boiler and the resistance requirements of both the boiler and the primary circuit.

Note: The control does not incorporate a facility for

switching duty/standby pumps. If required this must be facilitated externally to these controls.

Heating circuit pump

The heating pump is designated Q1. This must be connected to the boiler at terminals 'X2-02, Q1 heating circuit pump contactor'. The control signal is a start stop control that must be wired via suitable contactors and hand/auto switches for maintenance purposes.

Flow rate and resistance for the heating pump must be sized in accordance with the flow requirements for the heating circuit and the resistance requirements of the heating circuit.

Note: The control does not incorporate a facility for switching duty/standby pumps. If required this must be facilitated externally to these controls.

D.H.W. Circuit pump

The D.H.W. circuit pump is designated Q3. This must be connected to the boiler at terminals 'X2-04, Q3 DHW cylinder pump contactor'. The control signal is a start stop control that must be wired via suitable contactors and hand/auto switches for maintenance purposes.

Flow rate and resistance for the D.H.W. circuit pump must be sized in accordance with the flow requirements for the cylinder and the resistance requirements of the cylinder and pipework circuit.

Note: The control does not incorporate a facility for switching duty/standby pumps. If required this must be facilitated externally to these controls.

Room programmer

The single room programmer, QAA73, must be installed in the location most suitable for providing accurate space heating comfort control with the first heating circuit area (circuit using pump Q1). This must be connected to the boiler at terminals 'X10-01, room unit QAA73'.

Wiring should be completed using a 1.5mm² twisted pair shielded cable run separately to any mains cables to prevent electrical interference.

External air sensor

This must be installed on a North facing wall to prevent solar heating of the sensor and away from heat emitting items such as ventilation outlets. Connection is directly to the boiler at terminals 'X10-06, external air sensor QAC34'. Wiring should be completed using a 1.5mm² twisted pair shielded cable, run separately to any mains cables to prevent electrical interference. For further details regarding the sensor specification and fitting requirements

refer to appendix A at the rear of this manual.

D.H.W. Cylinder sensor

This should be fitted to the cylinder using the pocket provided on the cylinder to ensure accurate temperature detection. Connection is directly to the boiler at terminals' X10-05, D.H.W. cylinder sensor QAL36'. Wiring should be completed using a 1.5mm² twisted pair shielded cable, run separately to any mains cables to prevent electrical interference.

Note: The cable supplied with the sensor may require extending.

Features available with this system

- 7 Day time clock with 4 periods each day for heating circuit
- 7 Day time clock with 4 periods each day for hot water circuit
- Auto summer/winter time change (BST to GMT)
- Holiday program
- Frost protection for building
- Frost protection for hot water cylinder
- Reduced temperature (night setback)

- Reduced hot water storage temperature (night setback)
- Weather compensation
- Summer shutdown
- Fault diagnostics with error code indication
- Programmable lock to prevent tampering after commissioning

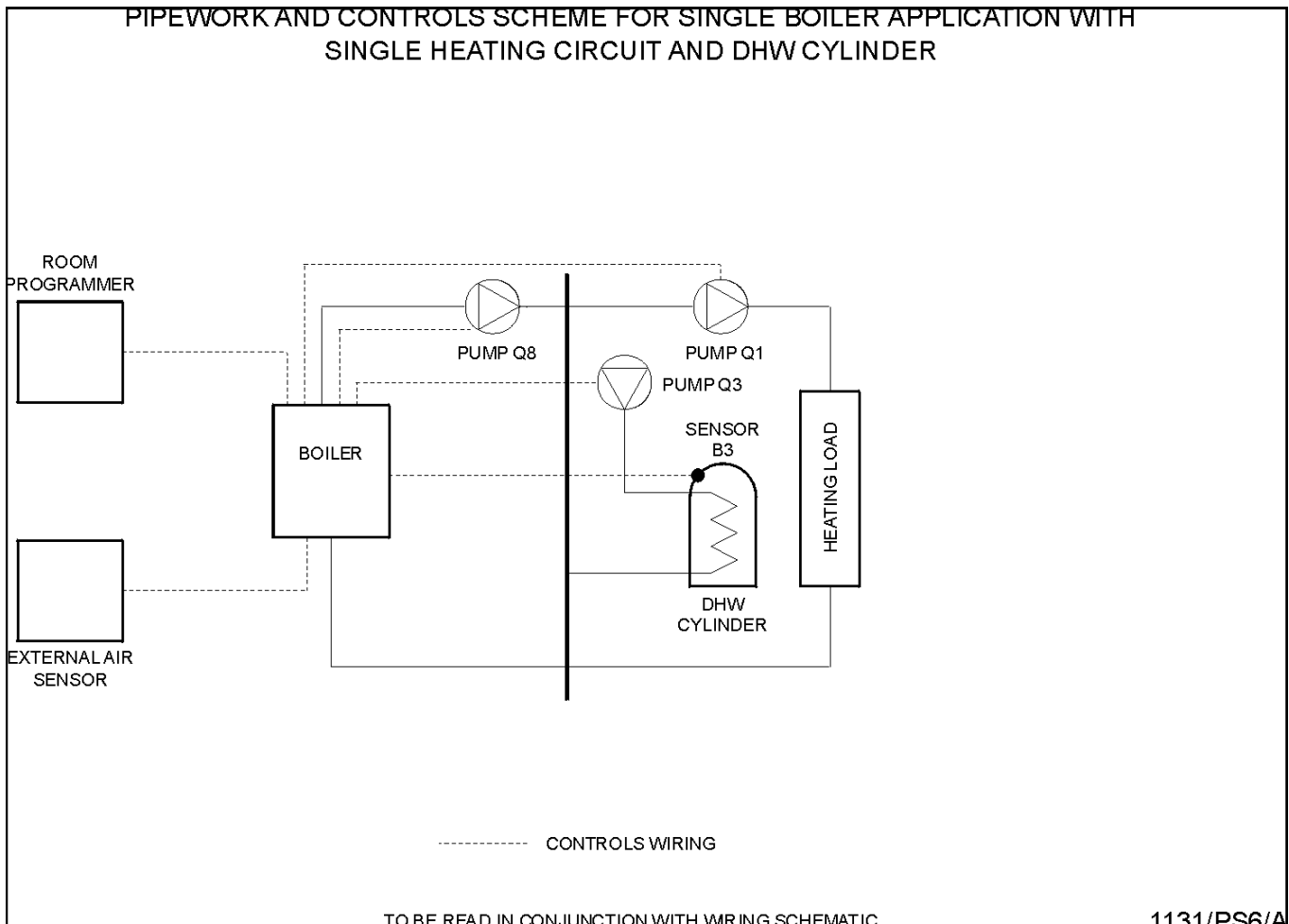

BOILER WIRING SCHEMATIC FOR SINGLE BOILER APPLICATIONS WITH SINGLE HEATING CIRCUIT AND DOMESTIC HOT WATER CYLINDER

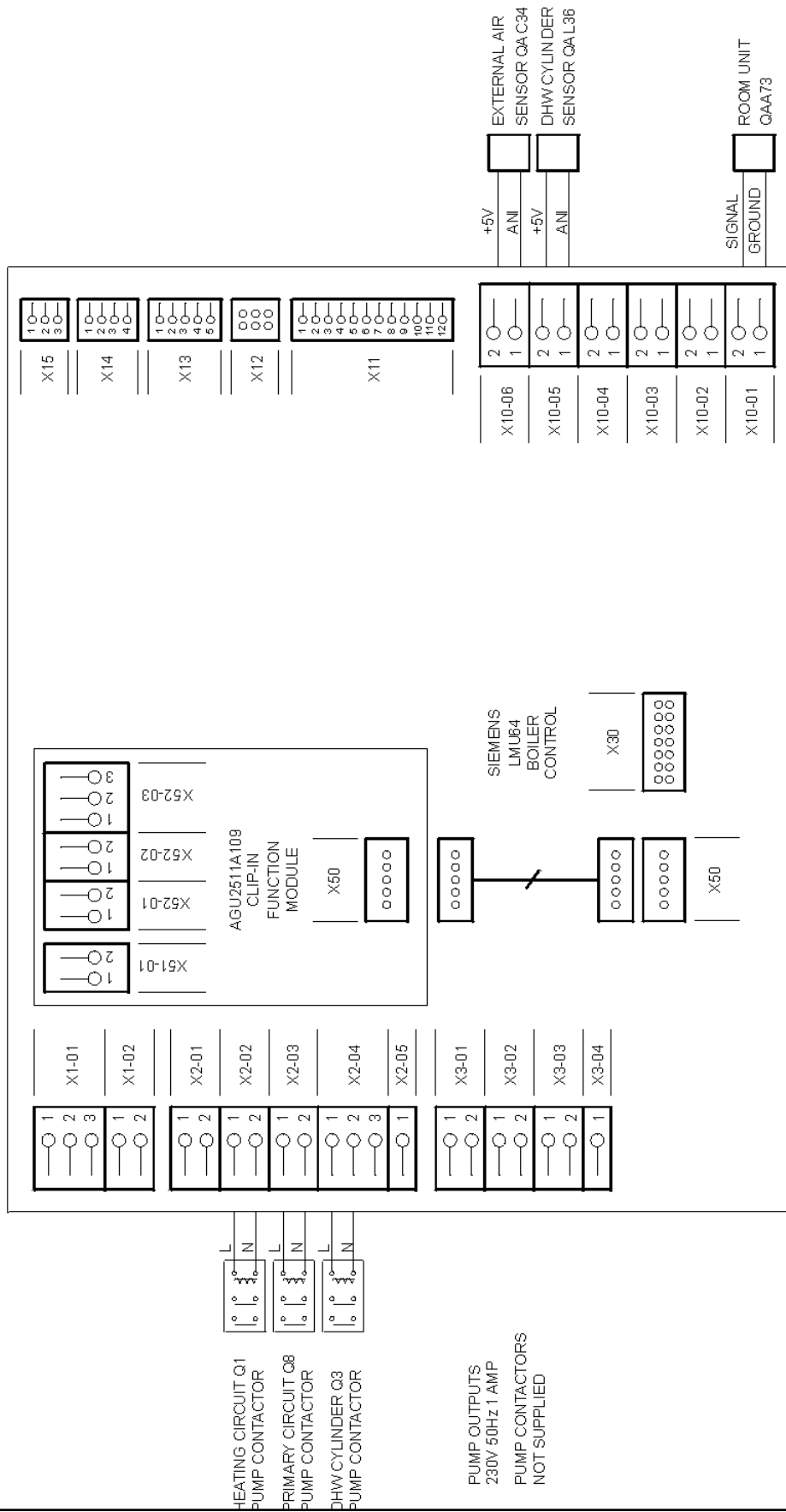

ALL EXISTING WIRING NOT SHOWN FOR CLARITY. REFER TO BOILER INSTALLATION MANUAL FOR BOILER WIRING DETAIL. INTERCONNECTING WIRING NOT SUPPLIED. SIGNAL CABLES MUST BE RUN IN SEPARATE CONDUITS TO MAINS CABLES.

1131/MS6/A

9.0 Twin Heating Circuits with Domestic Hot Water

Description of system type

All circuit pumps and temperature control is achieved via the boiler with the QAA73 room controller. Time clock and climate settings are programmed within the QAA73 room controller as part of the commissioning procedure.

The boiler controller, LMU64, will set the primary temperature according to the highest heat requirement, ie, if the D.H.W. cylinder requires a higher temperature than the heating circuits the primary temperature will be set to this. During this period the heating circuit pumps will be switched off to prevent overheating of the space.

Hardware required

1. Boiler incorporating LMU64 boiler management unit.
2. Room programmer QAA73. Programmable room unit kit including wiring terminal blocks for boiler LMU wiring connection, part number 563605337.
3. External air sensor QAC34. Part number 533901457.
4. D.H.W. Cylinder sensor QAL36. Sensor kit including wiring terminal blocks for boiler LMU wiring connection and immersion pocket, part number 563605338.
5. Second heating circuit clip-in relay AGU2.500A109. Relay kit including wiring terminal blocks for boiler LMU wiring connection, zone water temperature sensor QAL36 and immersion pocket, part number 563605339.

Fitting second heating circuit clip in relay kit AGU2.500A109

The clip-in relay is required to provide an output signal to enable the second heating circuit pump.

This clip-in relay must be fitted to the boiler control unit LMU64. In the open space alongside the standard relay the new clip-in must be firmly pushed into its mounting position.

Connect the clip-in relay using the ribbon cable supplied to terminal connection X40 at the boiler LMU64 controller.

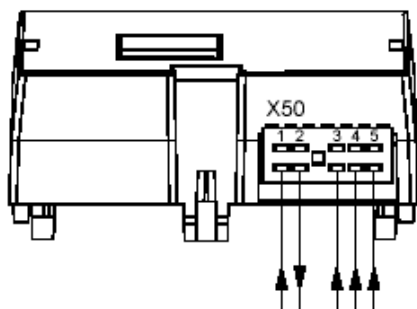

Power for the clip-in relay is supplied via the existing clip-in relay to the left of the second heating circuit clip-in relay. Using the 2 core cable supplied with the kit connect terminal block X52-01 of the second heating circuit relay to terminal block X52-01 of the existing relay. Ensure the Live supply is connected to terminal 1 and Neutral to terminal 2.

Wiring output to pump contactor (not supplied) from terminals 1 & 2 (L & N) block X52-02 of the clip-in relay.

Wiring output to the mixing valve (not supplied) from terminals 1,2&3 block X52-03 of the clip-in relay.

Frost protection

The building is protected for internal temperature using the QAA73 room programmer temperature

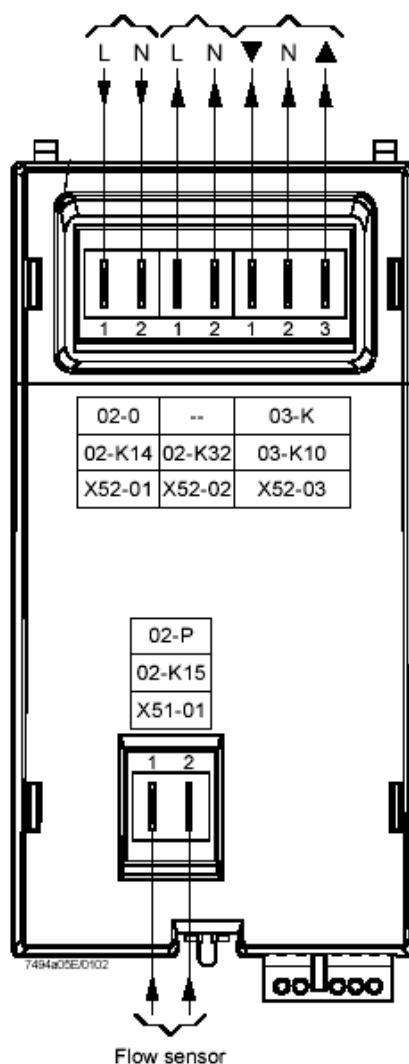

Connect the flow sensor, QAL36, supplied with the kit, using a twisted pair shielded cable, to terminals X51-01 on the second heating circuit clip-in relay.

sensor.

The boiler is internally protected for water temperature using the LMU64 temperature sensors. Also the D.H.W. cylinder is protected via the signal received from the cylinder sensor. Both boiler and hot water cylinder frost protection settings are pre-programmed in the boiler controls, not the QAA73 programmable room unit.

Primary circuit pump

The primary circuit pump is designated Q8. This must be connected to the boiler at terminals 'X2-03, Q8 primary circuit pump contactor'. The control signal is a start stop control that must be wired via suitable contactors and hand/auto switches for maintenance purposes.

Flow rate and resistance for the primary pump must be sized in accordance with the flow requirements for the boiler and the resistance requirements of both the boiler and the primary circuit.

Note: The control does not incorporate a facility for switching duty/standby pumps. If required this must be facilitated externally to these controls.

Heating circuit pump

The heating pump is designated Q1. This must be connected to the boiler at terminals 'X2-02, Q1 heating circuit pump contactor'. The control signal is a start stop control that must be wired via suitable contactors and hand/auto switches for maintenance purposes.

Flow rate and resistance for the heating pump must be sized in accordance with the flow requirements for the heating circuit and the resistance requirements of the heating circuit.

Note: The control does not incorporate a facility for switching duty/standby pumps. If required this must be facilitated externally to these controls.

Second heating circuit pump

The second heating circuit pump is designated Q2. This must be connected to the boiler using the clip-in relay terminals 'X52-02, Q2 2nd circuit pump contactor'.

Flow rate and resistance for the second heating circuit pump must be sized in accordance with the flow requirements for the second heating circuit and the resistance requirements of the second heating circuit.

Note: The control does not incorporate a facility for switching duty/standby pumps. If required this must be facilitated externally to these controls.

D.H.W. Circuit pump

The D.H.W. circuit pump is designated Q3. This must be connected to the boiler at terminals 'X2-04,

Q3 DHW cylinder pump contactor'. The control signal is a start stop control that must be wired via suitable contactors and hand/auto switches for maintenance purposes.

Flow rate and resistance for the D.H.W. circuit pump must be sized in accordance with the flow requirements for the cylinder and the resistance requirements of the cylinder and pipework circuit.

Note: The control does not incorporate a facility for switching duty/standby pumps. If required this must be facilitated externally to these controls.

Room programmer

The single room programmer, QAA73, must be installed in the location most suitable for providing accurate space heating comfort control with the first heating circuit area (circuit using pump Q1). This must be connected to the boiler at terminals 'X10-01, room unit QAA73'.

Wiring should be completed using a 1.5mm² twisted pair shielded cable run separately to any mains cables to prevent electrical interference.

External air sensor

This must be installed on a North facing wall to prevent solar heating of the sensor and away from heat emitting items such as ventilation outlets. Connection is directly to the boiler at terminals 'X10-06, external air sensor QAC34'. Wiring should be completed using a 1.5mm² twisted pair shielded cable, run separately to any mains cables to prevent electrical interference. For further details regarding the sensor specification and fitting requirements refer to appendix A at the rear of this manual.

D.H.W. Cylinder sensor

This should be fitted to the cylinder using the pocket provided on the cylinder to ensure accurate temperature detection. Connection is directly to the boiler at terminals 'X10-05, D.H.W. cylinder sensor QAL36'. Wiring should be completed using a 1.5mm² twisted pair shielded cable, run separately to any mains cables to prevent electrical interference.

Note: The cable supplied with the sensor may require extending.

Features available with this system

- 7 Day time clock with 4 periods each day for heating circuit
- 7 Day time clock with 4 periods each day for hot water circuit
- Auto summer/winter time change (BST to GMT)
- Holiday program
- Frost protection for building
- Frost protection for boiler
- Frost protection for hot water cylinder
- Reduced temperature (night setback)
- Reduced hot water storage temperature (night setback)
- Optimum start and stop
- Weather compensation
- Summer shutdown
- Fault diagnostics with error code indication
- Programmable lock to prevent tampering after commissioning

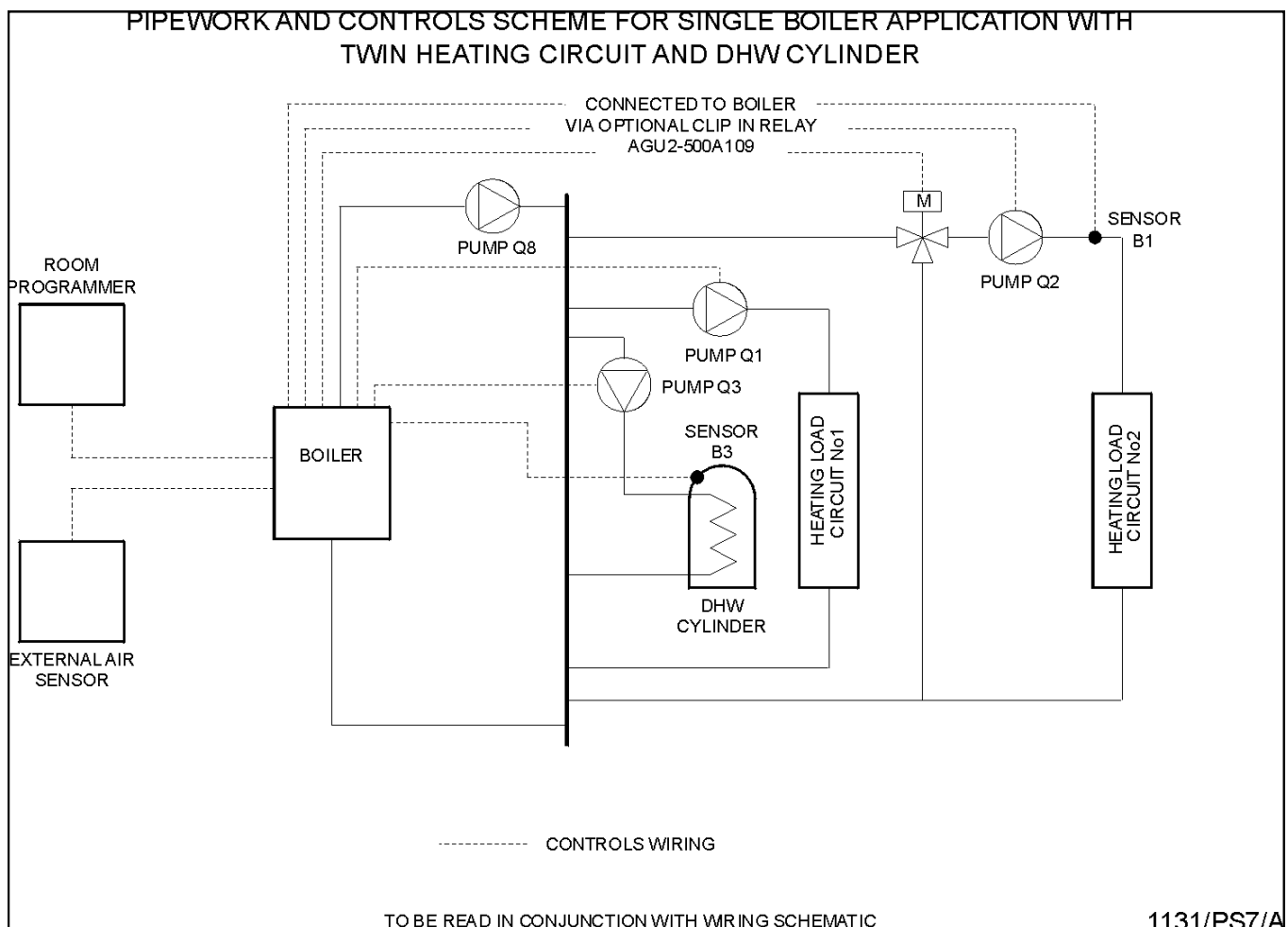

BOILER WIRING SCHEMATIC FOR SINGLE BOILER APPLICATIONS WITH TWIN HEATING CIRCUIT AND DOMESTIC HOT WATER CYLINDER

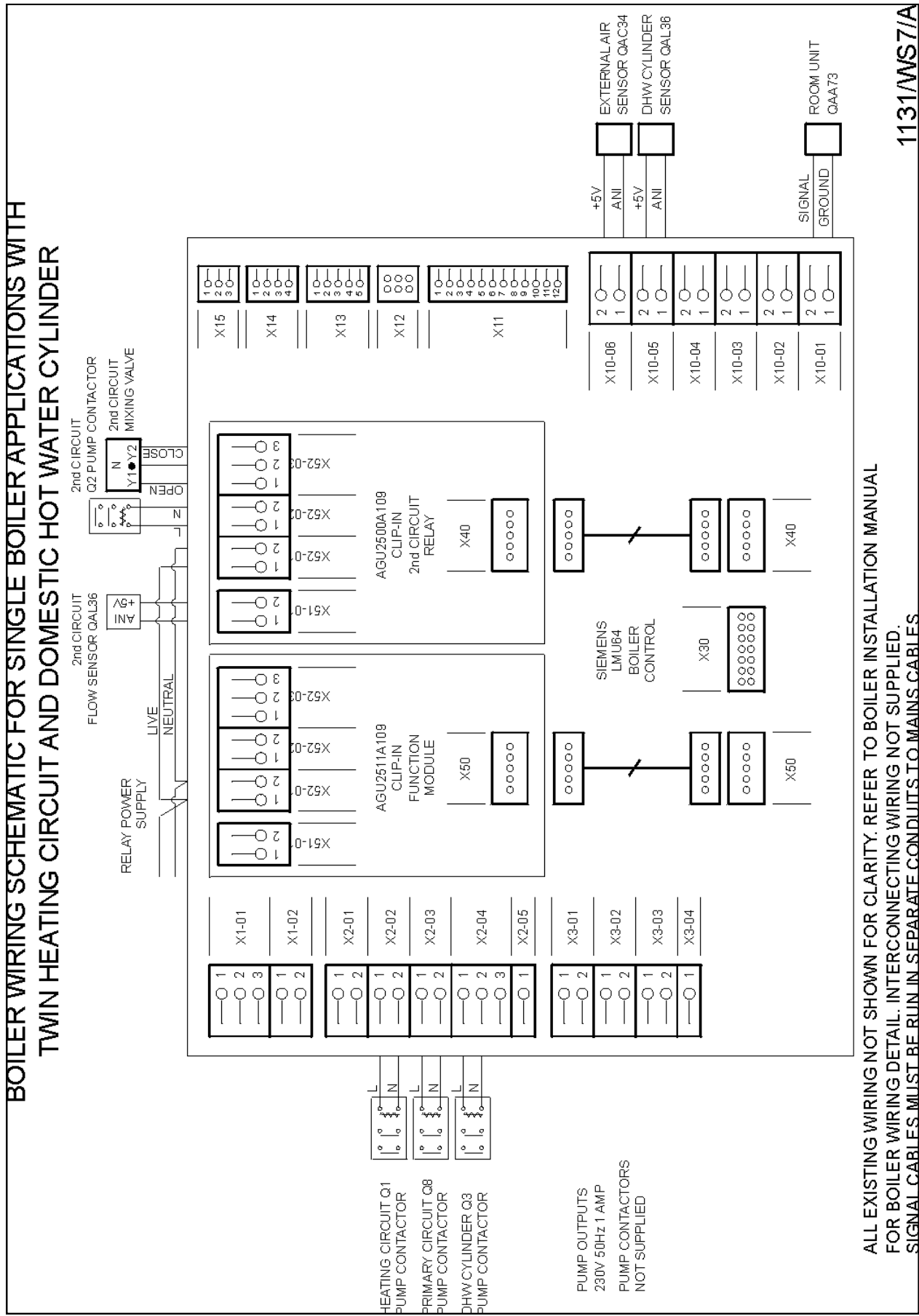

ALL EXISTING WIRING NOT SHOWN FOR CLARITY. REFER TO BOILER INSTALLATION MANUAL FOR BOILER WIRING DETAIL. INTERCONNECTING WIRING NOT SUPPLIED. SIGNAL CABLES MUST BE RUN IN SEPARATE CONDUITS TO MAINS CABLES.

1131/WS7/A

APPENDIX A: Sensors

External Air Sensor QAC34

The outside sensor consists of plastic housing with a removable cover. The sensing element is embedded in synthetic resin. The connection terminals are accessible after removal of the cover. To introduce the cable through the wall, a grommet, cable gland or sealing compound is required (also refer to illustration below). For wall mounting, a cable entry gland Pg 11 can be fitted to the bottom of the housing.

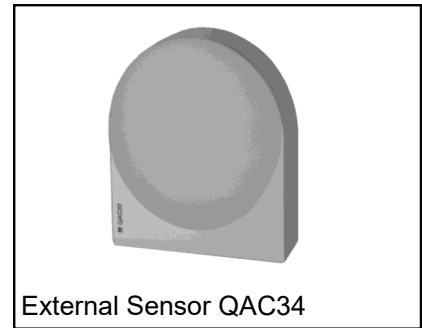

External Sensor QAC34

Type Ref	Sensing Element	Range (°C)	Tolerance (K*)	Time Constant (min)	Weight (g)	Copper Cable (mm ²) /Cable Dia (mm)	Perm. Cable Length (m)
QAC34/101	NTC1000Ω at 20°C	-50... 70	± 1	12	73	1.5 / 7.2	120

* QAC34/101 at -10 - +20C. The sensing element is an NTC resistor with a resistance of 1000Ω at 25°C. The resistance drops at about 4% per Kelvin.

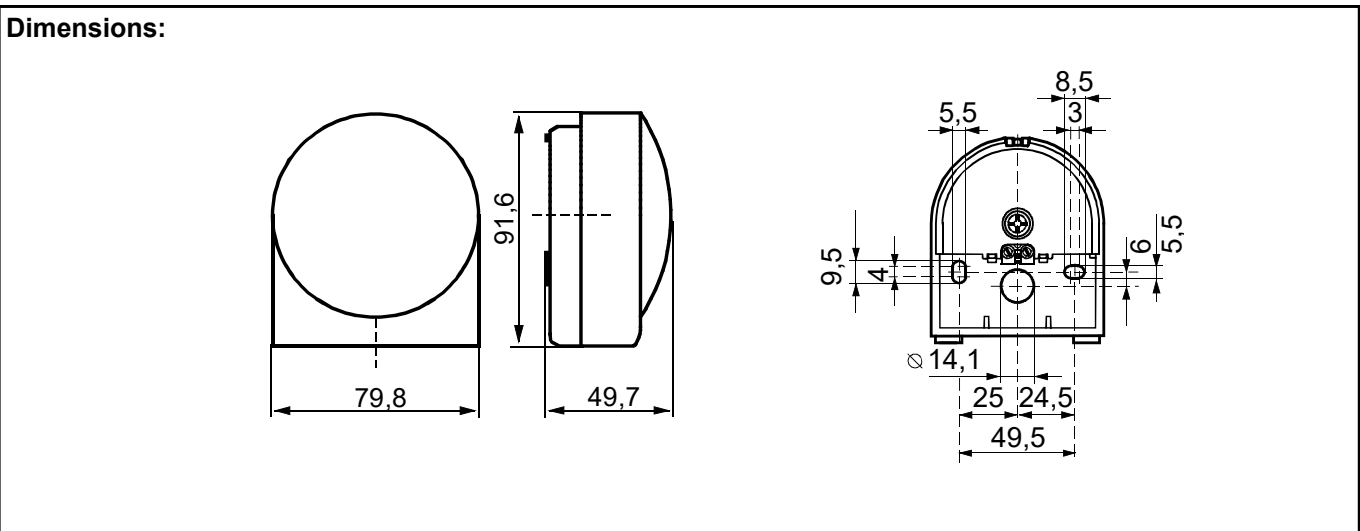
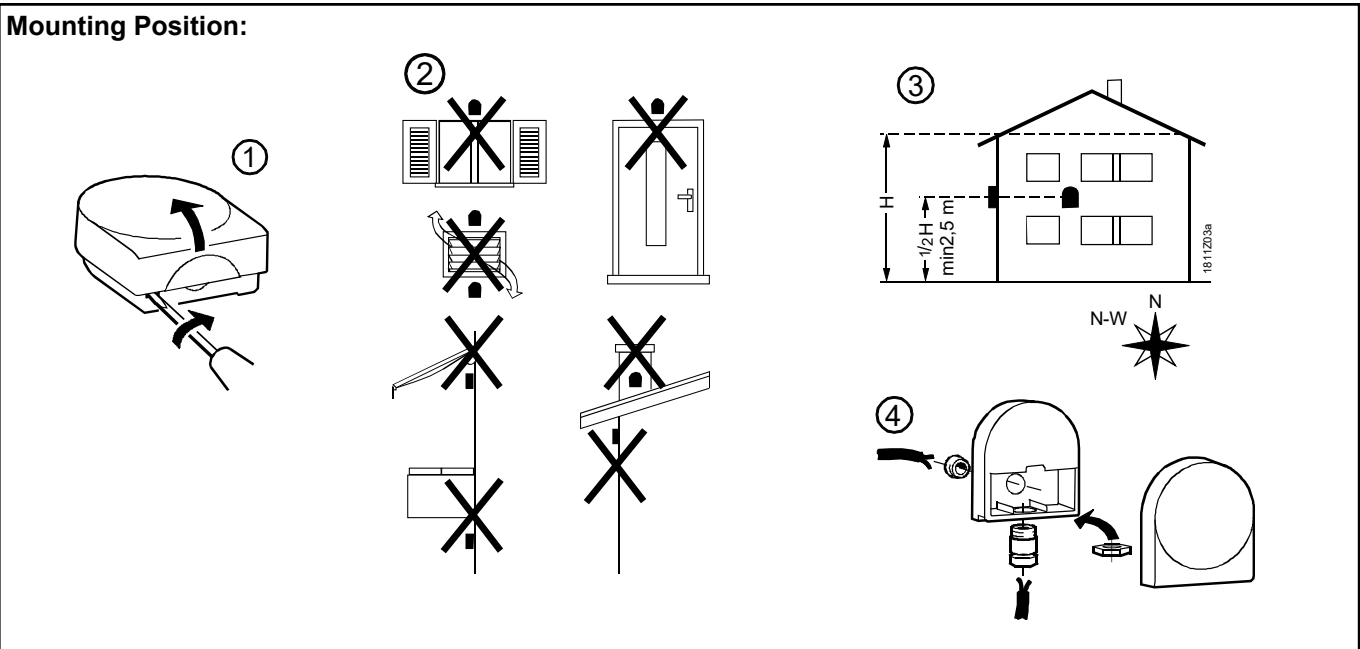

Notes

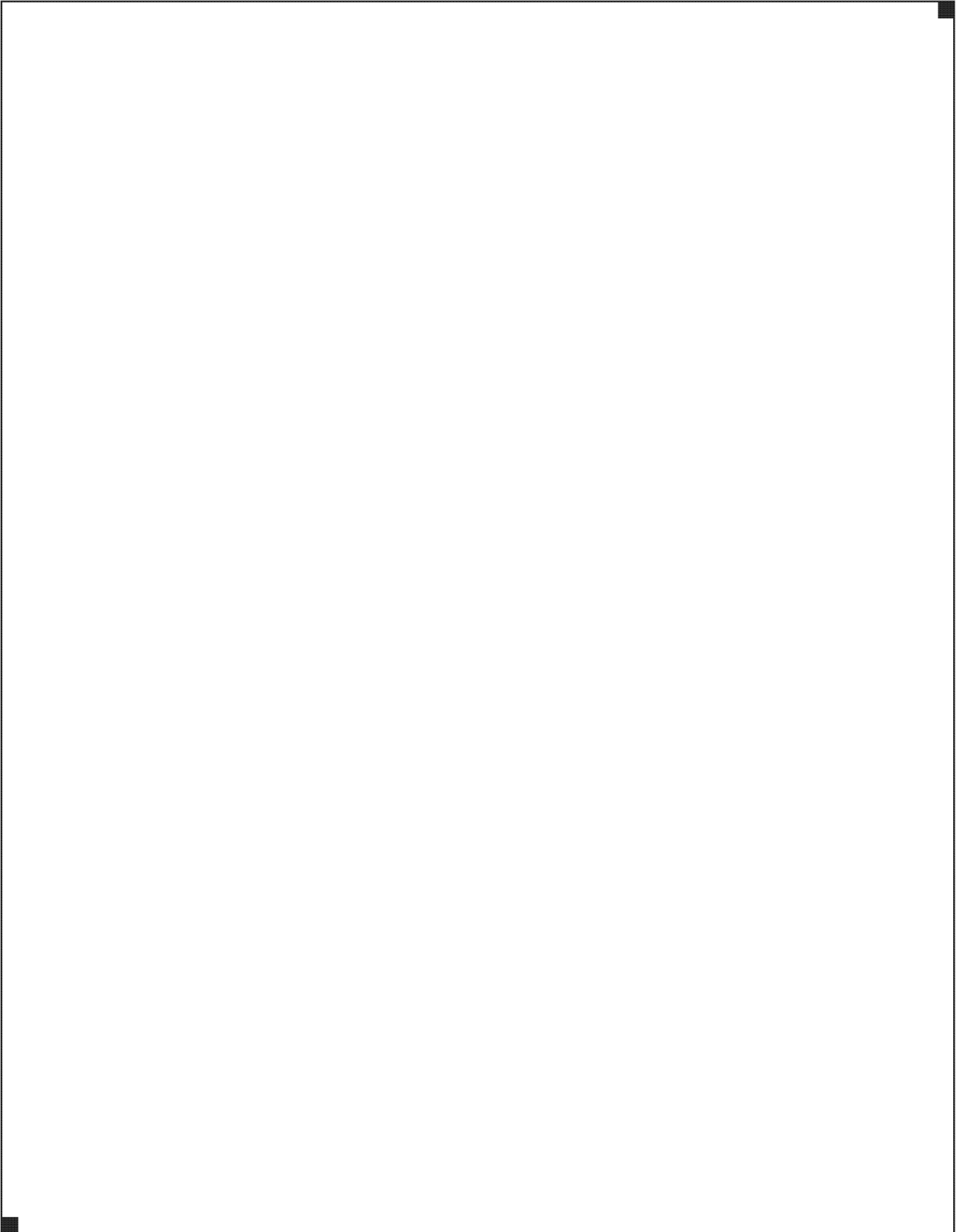

Hamworthy Heating Accredited Agents

Southern Ireland (Sales & Service)

HEVAC Limited
Naas Road, Dublin 12, Ireland
tel: **00 353 141 91919** fax: **00 353 145 84806**
email: info@hevac.ie

Scotland (Sales & Service)

McDowall Modular Services
2 Penson Road, Queenslie Industrial Estate, Glasgow, G33 4AG
tel: **0141 336 8795** fax: **0141 336 8954**
email:
MMS.McDowallModularServices@hamworthy-heating.com

Hamworthy Heating Customer Service Centre

Sales

tel: **01202 662552**
email: sales@hamworthy-heating.com

Technical Enquiries

tel: **01202 662505**
email: technical@hamworthy-heating.com

Servicing

tel: **01202 662555**
email: service@hamworthy-heating.com

Spares

tel: **01202 662525**
email: spares@hamworthy-heating.com

British engineering excellence from Hamworthy Heating;
the commercial heating and hot water specialists.



Customer Service Centre

Hamworthy Heating Limited,
Wessex House,
Units 7 & 8 New Fields Business Park,
Stinsford Road,
Poole,
Dorset,
BH17 0NF

Telephone: **01202 662555**
Fax: **01202 662522**
Email: service@hamworthy-heating.com
Website: www.hamworthy-heating.com