

Instinct Propane to Natural Gas Conversion



Kit Part Number	Description	Model
INSRKIT135	LP to NG Conversion	Instinct 110 Solo
INSRKIT136	LP to NG Conversion	Instinct 155 Solo & Combi
INSRKIT137	LP to NG Conversion	Instinct 199 Solo & Combi

Kit Part Number

- Natural Gas Venturi
- Venturi Inlet Seal
- Venturi/Blower O Ring
- Venturi/Blower Screws
- Gas Pipe Gaskets
- Rating Label
- Conversion Label

Recommended Tools

- Adjustable Wrench / 10 mm Socket & Ratchet
- Phillips Head Screwdriver
- Flat Head Screwdriver
- Calibrated Combustion Analyzer



Indicates a potentially hazardous situation which, if ignored, can result in serious injury or substantial property damage.



Indicates special instructions on installation, operation or maintenance, which are important to equipment but not related to personal injury hazards.



For your safety, turn off electrical power supply at service panel and allow unit to cool before proceeding to avoid possible electrical shock and scald hazard. Failure to do so can cause severe personal injury or death.



Failure to follow instructions below can result in severe personal injury or damage if ignored.

- **Instructions are for a qualified installer/ service technician only.**
- **Read all instructions before proceeding.**
- **Follow instructions in proper order.**



Upon completion of the conversion from Natural to Propane, Remove the Propane rating label



These instructions cover LP to NG conversion for Instinct boilers only. Each kit is supplied with one venturi suitable for use with that particular boiler model.

INSTINCT PROPANE TO NATURAL CONVERSION INSTRUCTIONS

1. Preliminary Instructions:

1. Verify that the venturi replacement kit is correct for the model of boiler. See page 1.
2. Turn off electrical power supply to the boiler.
3. Close the manual gas shut off valve to the unit.
4. Remove the front panel of the Instinct by removing the screw along the bottom edge of the unit. Pull the bottom of the panel forward and then lift to remove the front panel from the unit.
5. Using a voltmeter ensure there is no electrical power to the boiler by checking for power on the boiler's high voltage terminals L and N.



WARNING

ELECTRICAL SHOCK HAZARD

Ensure power to the boiler has been disconnected prior to servicing the unit.

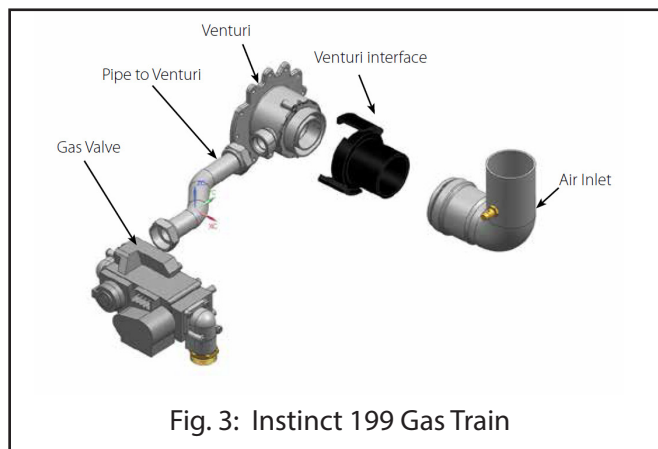
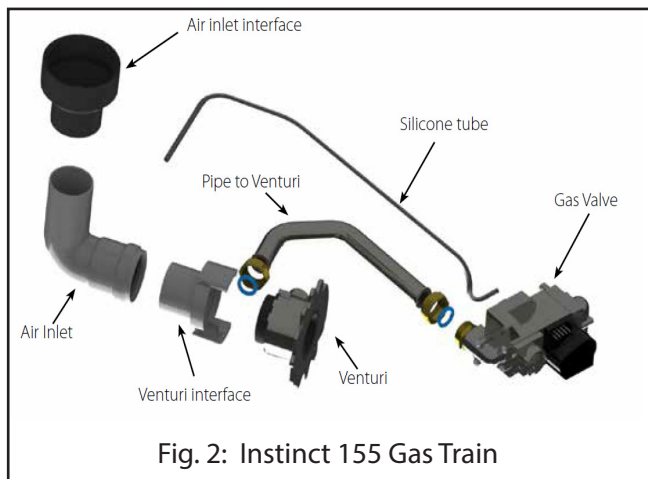
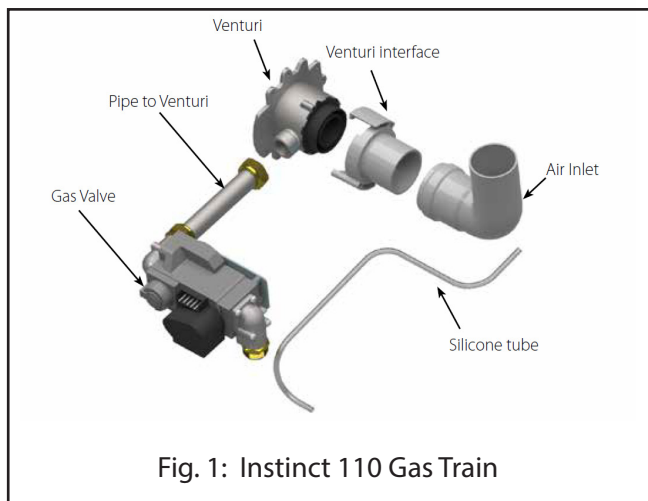

2. Removal of Propane Venturi

1. Remove the silicone tube from the air inlet elbow, then remove the air inlet elbow.
2. Rotate the venturi interface approximately 60° clockwise to release the clamping mechanism and remove the venturi interface.
3. Remove the gas valve to venturi pipe by loosening the nuts at both ends of the pipe with an adjustable wrench.

NOTICE

There are gaskets at both ends of the gas valve to venturi pipe. These gaskets must be reinstalled along with the pipe. Use care not to damage the gaskets.

4. Using a 10 mm socket and ratchet, remove the three (3) bolts securing the venturi to the fan assembly and remove the natural gas venturi from the unit, making sure not to damage the blower O-ring gasket.

3. Install the Natural Gas venturi

1. Verify the following when aligning the Natural Gas venturi:
 1. The UP arrow on the plastic housing is pointing upward.
 2. The threaded connection for the gas piping is in the correct orientation for re-fitting the gas pipe.

INSTINCT PROPANE TO NATURAL CONVERSION INSTRUCTIONS



Failure to retain the O-ring gasket between the venturi and the blower will cause an improper seal resulting in a potential risk of a gas leak. A gas leak can result in substantial property damage, serious injury, or death.



Ensure the proper venturi for the model is installed per Table 1. Failure to comply will affect input rate and combustion of the boiler which can result in substantial property damage, serious injury, or death.

2. Install the new venturi/blower gasket into the blower.



Do not use adhesive on any gaskets or O-rings during the re-assembly process.

3. Using a 10 mm socket and ratchet, reinstall the three (3) bolts securing the venturi to the fan assembly
4. Reassemble the gas valve to venturi pipe to the gas valve and venturi taking care to ensure that the gaskets are seated properly before tightening the nut.
5. Install the venturi interface on the venturi and rotate counterclockwise until locked into place.
6. Install the air inlet elbow then attach the silicone tube.



Failure to properly install the air inlet elbow and attach the silicone tube can affect combustion of the boiler which can result in substantial property damage, serious injury, or death.

7. Open the manual gas shut off valve to the unit. Before placing the boiler back into operation, test all gas connections for leaks and repair if leaks are found.



Do not check for gas leaks with an open flame. Use a bubble test. Failure to test for gas leaks can result in substantial property damage, serious injury, or death.

8. Attach the Natural Gas conversion label (Fig. 4) to the side of the boiler and the rating label label (Fig. 5) over the applicable part of the existing rating label

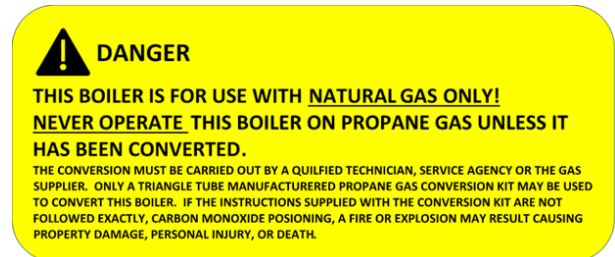

Fig. 4: Natural Gas Conversion Label

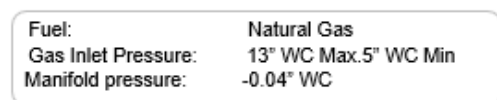

Fig. 5: Natural Gas Rating Label

9. Enter the Natural Gas (NG) appliance code from the rating label:

1. Press and hold the UP and DOWN buttons together see Fig. 6.

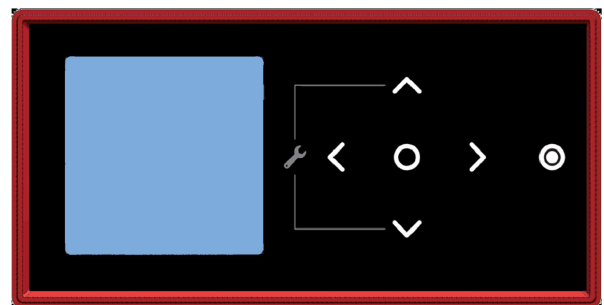

Fig. 6: CTRLMax Navigation Control

2. Enter the installer access code "054" by using the LEFT and RIGHT buttons to select a digit and the UP and DOWN buttons to change the digit. Press the center button to enter the access code.
3. With the CH/DHW Settings icon highlighted, press the center button.
4. Press the DOWN button to highlight the Boiler Settings icon then press the center button.

INSTINCT PROPANE TO NATURAL CONVERSION INSTRUCTIONS

5. Scroll down to highlight Appliance Setting then press the center button.
6. Enter the Natural Gas (NG) appliance code from the rating label by using the LEFT and RIGHT buttons to select a character and the UP and DOWN buttons to change the character. Press the center button to enter the appliance code.

4. Combustion Test and Adjustments

NOTICE

The installer **MUST** perform a complete combustion check to ensure the following combustion levels are met at high and low input firing rates and the burner is operating at optimum conditions.

WARNING

The combustion testing and adjustments must be performed by a qualified installer, service agency or the gas supplier. All combustion measurements must be performed with calibrated equipment to ensure proper readings and accuracy.

WARNING

Failure to perform a complete combustion test at both high and low input rates may result in incomplete combustion and the production of carbon monoxide, which can cause severe personal injury, death or substantial property damage.

1. Touch simultaneously on the up and down soft keys for 3 seconds to access the functions for the installer. See Fig. 6.
2. Enter the installer access code "054" by using the LEFT and RIGHT buttons to select a digit and the UP and DOWN buttons to change the digit. Press the CENTER button to enter the access code.
3. Press the RIGHT button to highlight the Manual Operation icon then press the CENTER button.

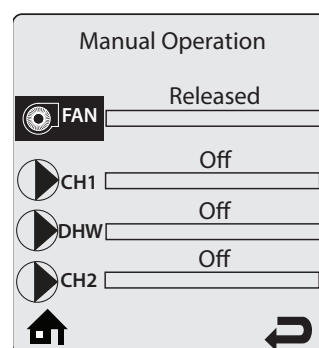

Fig. 7: CTRLMax Manual Operation

4. Press the CENTER button while the FAN icon is highlighted to manually fire the burner and power the CH circulator. See Fig. 7

NOTICE

An adequate CH load must be present to dissipate the heat generated during the combustion test. If an adequate CH load is not available, an indirect water heater can be used to dissipate the heat by creating a DHW call which will enable the DHW circulator.

5. Press the RIGHT button to adjust the firing rate to 100% (high fire). Hold down the RIGHT button to rapidly increase the firing rate.
6. If the combustion levels during high fire are outside the recommended combustion settings (see Table 1), adjust the THROTTLE SCREW (see Fig. 8) using a flat-blade screwdriver as follows:

Counter-clockwise adjustment of the THROTTLE SCREW at High Fire (100% firing rate):

O₂ decreases and CO₂ increases

Clockwise adjustment of the THROTTLE SCREW at High Fire (100% firing rate):

O₂ increases and CO₂ decreases

7. Once the combustion level is set at high fire, manually place the boiler into low fire mode by pressing the LEFT button to adjust firing rate down to 1% (low fire).
8. If the combustion level (O₂ or CO₂) during low fire is not are outside the recommended combustion settings in Table 1 contact Triangle Tube Technical Support.

INSTINCT PROPANE TO NATURAL CONVERSION INSTRUCTIONS

9. Press the CENTER button while the fan icon is highlighted to shutdown the burner.

11. Replace the front panel and put the boiler back into operation.

10. Press the LEFT or RIGHT button to highlight the home screen icon to exit the service mode.

Table 1: Combustion Settings

		Natural Gas 110, 155	Natural Gas 199	Propane (All Models)
HIGH FIRE	CO2 Range	9.0 to 10.5%	8.5 to 10.5%	10.4 to 11.0%
	CO2 Target	9.50%		10.80%
	O2 Range	4.85 to 2.15 %	5.75 to 2.15 %	5.1 to 4.2 %
	O2 Target	3.95%		4.50%
	CO Max	<150 ppm @ 9.5% CO2		<200 ppm @ 10.8% CO2
LOW FIRE	CO2 Range	9.0 to 10.0 %	8.5 to 10.0 %	10.4 to 11.0 %
		Target values are equivalent to High Fire values, ensure CO2 values measured are less than or equal to High Fire CO2 measurements		Target values are equivalent to High Fire values, ensure CO2 values measured are less than or equal to High Fire CO2 measurements
	O2 Range	4.85 to 3.0 %	5.75 to 3.0 %	5.1 to 4.2 %
		Target values are equivalent to High Fire values, ensure O2 values measured are higher than or equal to High Fire O2 measurements		Target values are equivalent to High Fire values, ensure O2 values measured are higher than or equal to High Fire O2 measurements
CO Max	10 ppm		10 ppm	

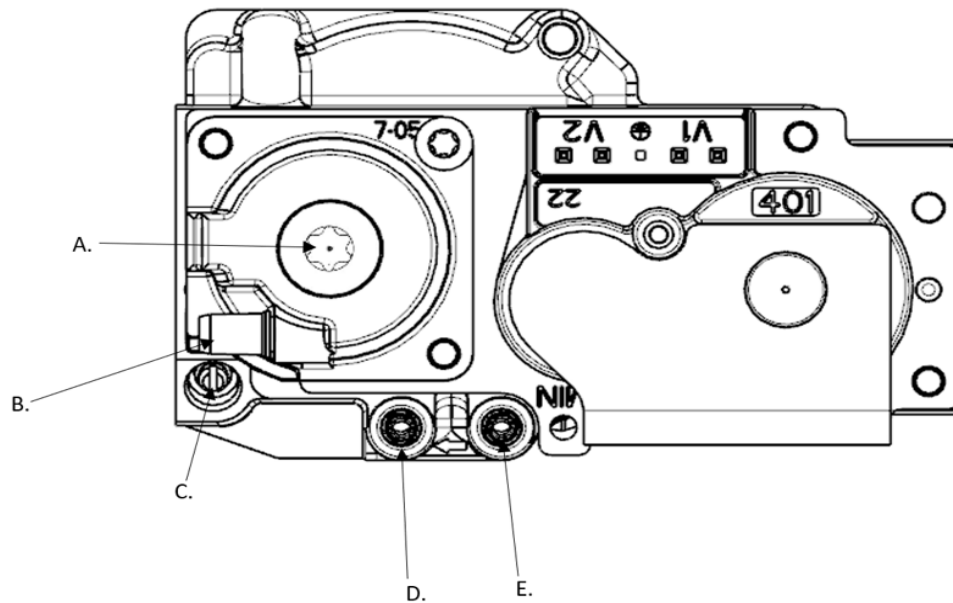

- A. Low Fire (Offset) Cap & Adjustment Screw
- B. Reference Pressure Connection
- C. High Fire Adjuster (Throttle)
- D. Low Fire Pressure (Offset Pressure)
- E. Gas Inlet Pressure

Fig. 8: Throttle Screw Location