

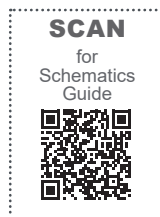

QUICK START GUIDE

HP290 MONOBLOC HEAT PUMP SYSTEM



IMPORTANT!
READ BEFORE COMMISSIONING

When replacing any part on this appliance, use only spare parts that you can be assured conform to the safety and performance specification that we require. Do not use reconditioned or copy parts that have not been clearly authorised by Ideal Heating.

For the very latest copy of literature for specification and maintenance practices visit our website idealheating.com where you can download the relevant information in PDF format.



NOTES FOR THE INSTALLER

For any technical queries please contact the Ideal installer helpline : 01482 498663

SAFETY DEFINITIONS

 **WARNING: Risk of injury or death.**

 **CAUTION: Risk of damage to objects.**

 **IMPORTANT: notes to make you aware.**

 **WEEE DIRECTIVE 2012/19/EU**
Waste Electrical and Electronic Equipment Directive

- At the end of the product life, dispose of the packaging and product in a corresponding recycle centre.
- Do not dispose of the unit with the usual domestic refuse.
- Do not burn the product.
- Remove the batteries.
- Dispose of the batteries according to the local statutory requirements and not with the usual domestic refuse.



The code of practice for the installation, commissioning & servicing of central heating systems



NOTE TO INSTALLER: COMPLETE THE BENCHMARK COMMISSIONING CHECKLIST AT THE REAR OF THIS BOOK AND LEAVE THESE INSTRUCTIONS WITH APPLIANCE

Ideal Heating reserve the right to vary specification without notice

CONTENTS

1.1	Risks and Warning	3
1.2	HP290 Control Box/Controller Configuration	4
1.2.1	HP290 Cylinder or HP290 Control Box	4
1.2.2	HP290 Controller	5
1.3	HP290 System Parameter Update using USB	6
1.4	Enabling CH operation	7
1.4.1	Temperature Curve	8
1.5	Enabling CH Zone 2 (if applicable)	9
1.5.1	Setting Emitter Type	10
1.6	Operating Status	11

1.1 RISKS AND WARNING

⚠ WARNING: Failure to obey the warnings can result in death or severe injury. Detailed hazardous events and how to prevent them are presented in their relevant sections throughout the document.

Flammable Refrigerant

- The heat pump is charged with R290 which is a flammable, odourless, and colourless refrigerant. In the event of a leak from the refrigerant circuit this can create a hazardous environment. To reduce the risk of a hazardous event, the installation instructions must be followed, and the installation area must be kept clear of ignition sources, including but not limited to; electrical switches, electrical plug sockets, and lamps.

Transport & Storage of Boxed Unit

- The heat pump must be transported and stored in an upright position. When still in the packaging, the product and surrounding area should be kept clear of ignition sources and should be handled with caution.

Installation & Safety Devices

- If the installation requirements of this document are not upheld there is increased risk of a hazardous event occurring. All pre-installation checks and the specific installation requirements of each individual product and the system must be implemented and obeyed.

Modification of the Products and Installation Environment.

- The product is not to be modified or tampered with in any way that is not defined and approved by this document. Make sure that the requirements for both the products and installation environments are always followed. The end user should be properly informed of the installation area and product requirements during the handover process.

Improper Maintenance

- The product is to be regularly maintained and serviced by an appropriately qualified service engineer. The end user should be properly informed of maintenance and care requirements during the handover process.

Inappropriate Operation

- The product is to be operated as outlined in both this document and the user manuals. The end user must be properly informed of intended and acceptable operation methods during the handover process.

Electrical Risk

- Work on electrical components must only be carried out by a competent electrician. Electrical supplies must be locked in the off position when any work is done near electrical components. Failure to comply with this requirement can result in severe injury or death.

If any of the supply cables are damaged, they must be replaced by the manufacturer, its service agent or similarly qualified persons in order to avoid a hazard.

Correct Disposal of Waste

- Waste from the products, such as cardboard, plastics, and refrigerant must be disposed of appropriately and recycled where applicable. Refrigerant must not be released into the atmosphere.

Presence of Frozen Condensate in Walkways

- There is condensate produced by the Heat Pump which can potentially build up around the heat pump and freeze if not properly disposed of. Appropriate disposal methods of the condensate should be implemented and maintained to prevent slipping hazard.

Safe Handling

- The installer is responsible for their own health and safety. The manufacturer recommends that the installer refers to the newest revision of the guidance given in HSE document L23, Manual Handling Operations Regulations 1992 (Fourth Edition). The installer must do their own risk assessment to identify the correct and safest method of handling the heat pump (HSE Guide L23 - <https://www.hse.gov.uk/pubns/priced/l23.pdf>).

1.2 HP290 CONTROL BOX/CONTROLLER CONFIGURATION

⚠ WARNING: All electrical work is to be undertaken by a competent electrician. The electrical supply is to be switched off with appropriate safety measures in place to prevent accidental activation. The electrical installation must be done on the Heat Pump first and connection to the supply must be the last connection made to reduce risk of electric shock.

ⓘ IMPORTANT: Before the Ideal HP290 Monobloc is powered up for the first time, you must configure the unit to use the correct type of controller. Refer to the **INSTALLATION & MAINTENANCE MANUAL** for further details.

ⓘ IMPORTANT: When installing a Hybrid system make sure that you use this manual with the **HP290 HYBRID INSTRUCTION MANUAL**.

1.2.1 HP290 Cylinder or HP290 Control Box

Configure the HP290 Monobloc as follows:

1. Remove the HP290 Monobloc top and side panels. Refer to the HP290 Installation & Maintenance manual 4.1.7 Accessing the Casing.
2. Gain access to the HP290 Monobloc Outdoor Control PCB (see Figure 2). Remove and keep the PCB cover retaining screws and remove the cover.
3. **Make sure that DIP switch S2 (switch 1) is set to the ON position, see Figure 4.**
4. Update the system parameters using the supplied USB. Refer to Sect 1.3. For system parameters see Table 1.
5. Put the Control Box cover in position and install the cover retaining screws.
6. Install the HP290 monobloc top and side panels. Refer to the HP290 Installation & Maintenance manual 4.1.7 Accessing the Casing.

Table 1 USB changed parameters

Item	Parameter	Default	USB value
1	dT5_ON	10°C	7°C
2	T4DHWMIN	-10°C	-25°C
3	T5S_DISINFECT	65°C	60°C
4	T_DHWHP_MAX	90 mins	60 mins
5	Cooling Mode	0 (ON)	1 (OFF)
6	T4HMAX	25°C	21°C
7	T4HMIN	-15°C	-20°C
8	Zone 2 H-emission	2 (Underfloor)	1 (Radiators)
9	Room thermostat	0 (None)	2 (One zone)
10	T4_AHS_ON	-5°C	7°C
11	P_TBH	2 kW	3 kW

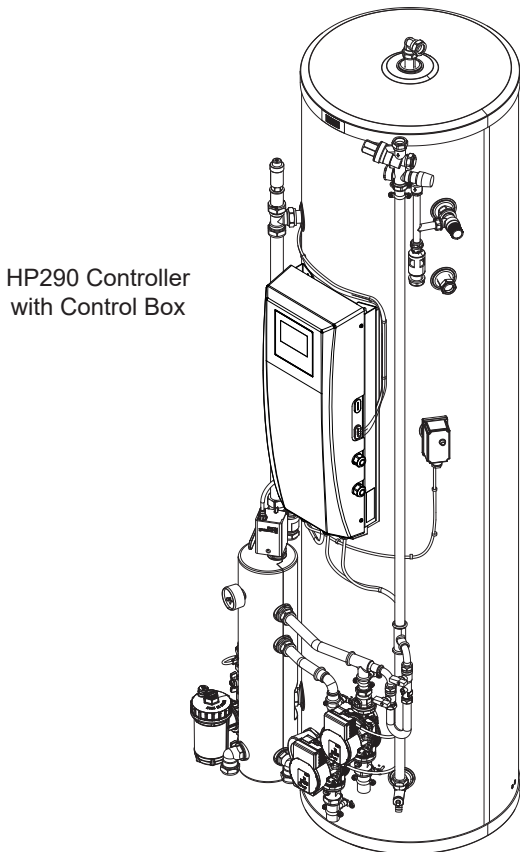

or

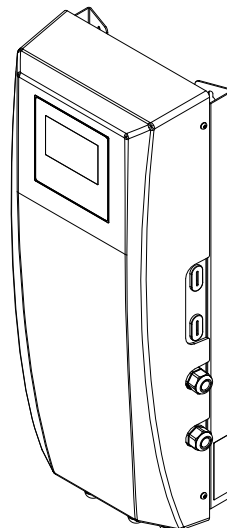

Figure 1. Types of HP290 Control Box which require DIP Switch S2 Position 1 to be set to ON

⚠ WARNING: The product contains the hydrocarbon refrigerant R290 which is very flammable. The refrigerant may mix with air to form a flammable atmosphere increasing the risk of fire and/or explosion. Work that requires the removal of the exterior casing of the Heat Pump must only be carried out by competent persons who are familiar with the risks of R290 refrigerant. Work on the refrigeration circuit must only be carried out by a Cat I or Cat II F-gas certified engineer with a City and Guilds 6187-21 certificate or equivalent. Work done on the heat pump should be done in accordance with industry standard safety procedures and practices for working with hydrocarbons.

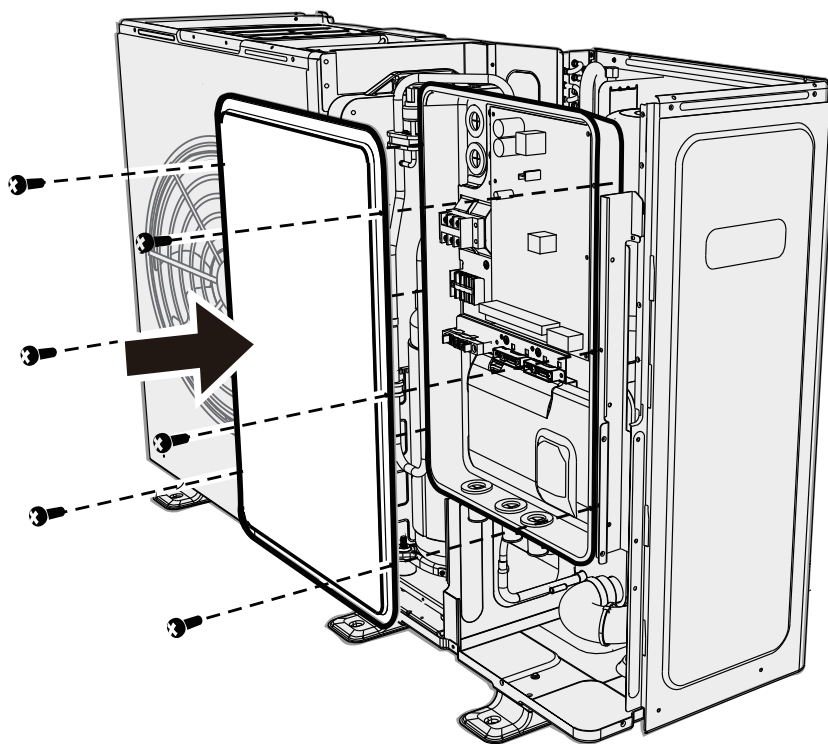

Figure 2. HP290 Monobloc (Access to Outdoor Control PCB)

1.2.2 HP290 Controller

Set the HP290 Monobloc DIP switch as follows:

1. Remove the HP290 Monobloc top panels. Refer to the HP290 Installation & Maintenance manual 4.1.7 Accessing the Casing.
2. Gain access to the HP290 Monobloc Outdoor Control PCB. Remove and keep the Control Box cover retaining screws and remove the cover.
3. **Make sure that DIP switch S2 (switch 1) is set to the OFF position, see Figure 4.**
4. Update the system parameters using the supplied USB. Refer to Sect 1.3. For system parameters see Table 1.
5. Put the Control Box cover in position and install the cover retaining screws.
6. Install the HP290 monobloc top and side panels. Refer to the HP290 Installation & Maintenance manual 4.1.7 Accessing the Casing.

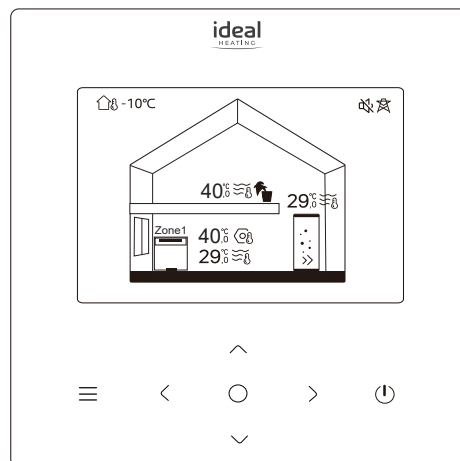

Figure 3. HP290 Heat Pump Controller

1.3 HP290 SYSTEM PARAMETER UPDATE USING USB

⚠ WARNING: All electrical work is to be undertaken by a competent electrician. The electrical supply is to be switched off with appropriate safety measures in place to prevent accidental activation. The electrical installation must be done on the Heat Pump first and connection to the supply must be the last connection made to reduce risk of electric shock.

Commission the Heat Pump USB as follows:

1. Make Make sure that the appliance power is set to OFF.
2. On the Outdoor PCB (Figure 4) insert the USB stick (provided) into the slot marked CN4 USB.

3. Power up the indoor unit and then power up the outdoor unit. Wait until the Control display shows the USB FUNCTION window (Figure 5).

Note 1. This may take up to 30 seconds.

Note 2. Do not touch the display during this time. If the display is touched, the system will return to the Home screen and you will have to do Step 1 again.

4. On the Control Box, press \checkmark to scroll through the options. When WRITE SET PARAMETER is illuminated on the display (Figure 5), press O (to select the option).
5. When a pop-up window shows SUCCESS, set the power on the indoor and outdoor units to OFF.
6. Remove the USB stick.
7. Set the power on the indoor and outdoor units to ON.

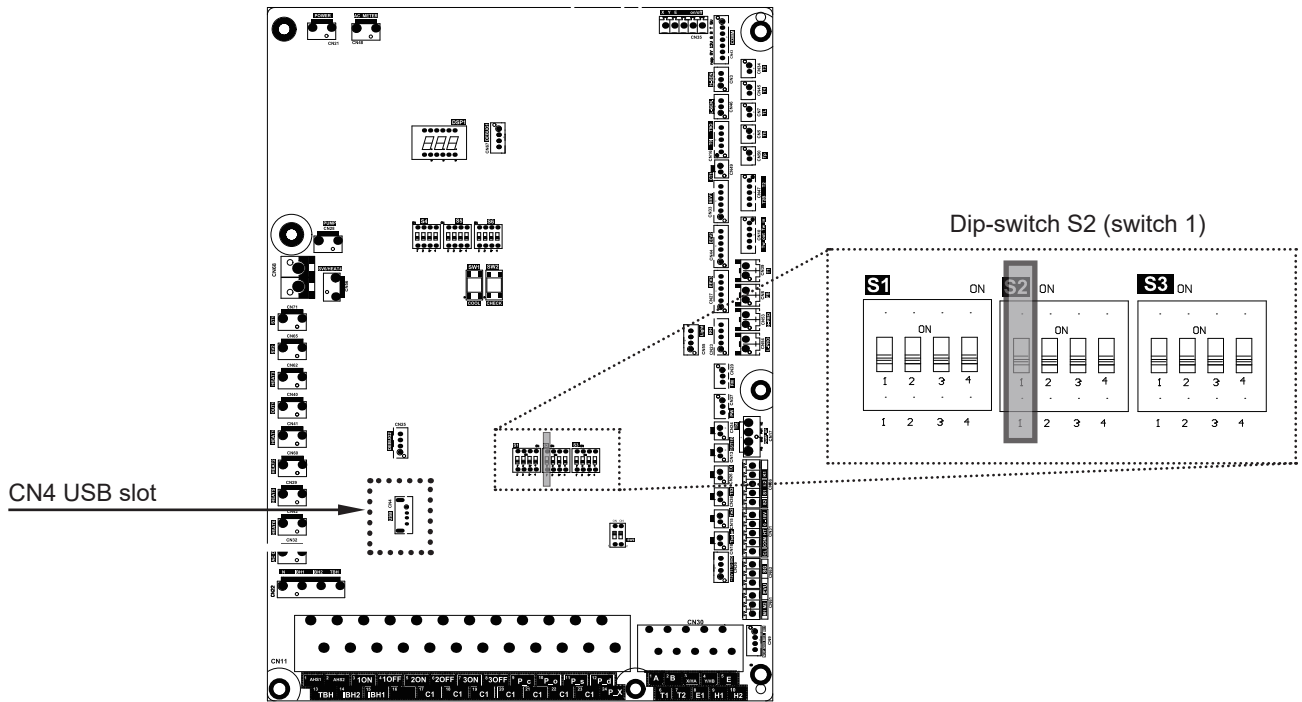

Figure 4. Outdoor PCB

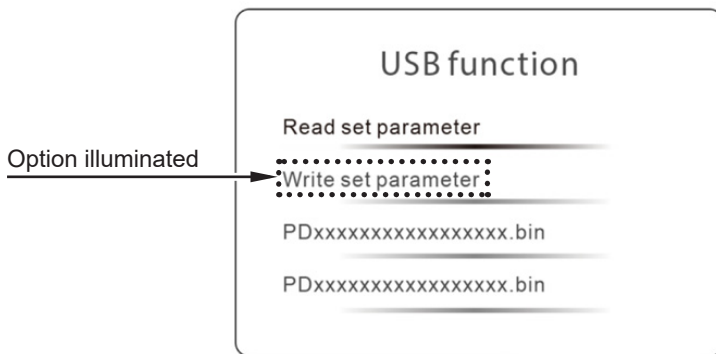
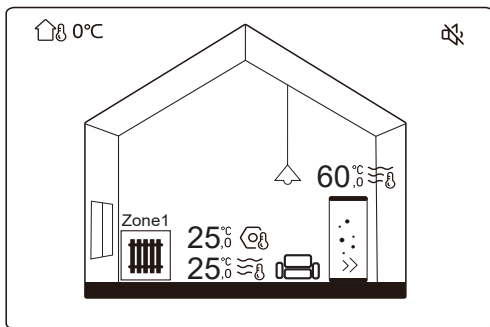

Figure 5. Control Box display

1.4 ENABLING CH OPERATION

Enable CH operation as follows:



From the Home Screen (above), press \equiv to move to the Menu page (below).

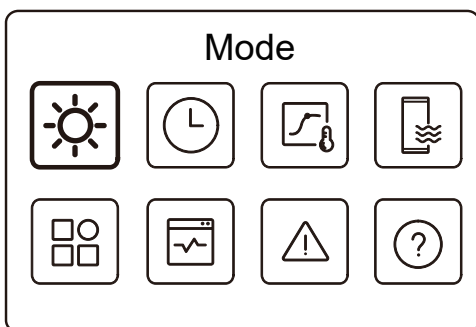

Press \triangleright twice to highlight the Weather temp. settings option, then press \circ and the below will be shown.

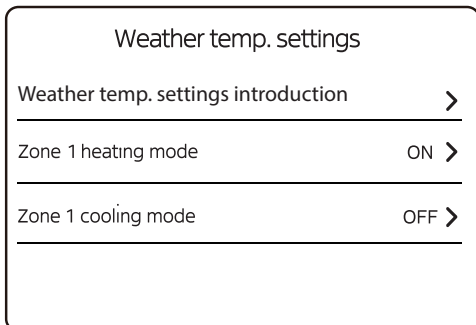

Press \surd to highlight **Zone 1 heating mode** then press \circ and the following screen will be shown.

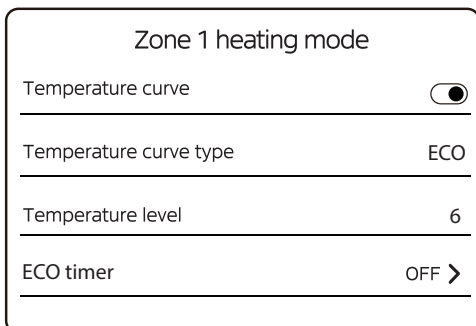

Press \circ so that Temperature curve is enabled, then press \surd twice so that **Temperature level** is highlighted, press \surd until either 6 (radiators) or 4 (underfloor heating) is shown and press \circ to store.

If there is a second zone then configure this in the same manner.

1.4.1 Temperature Curve

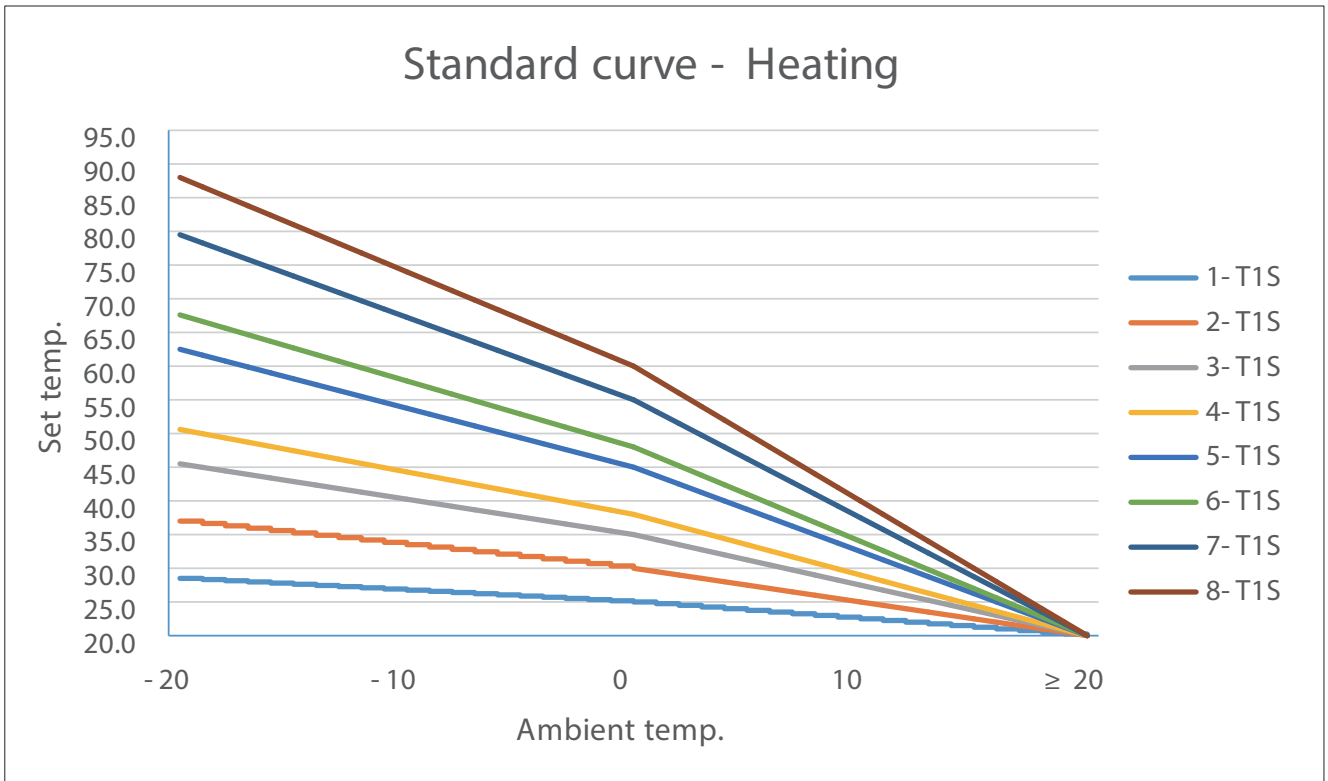
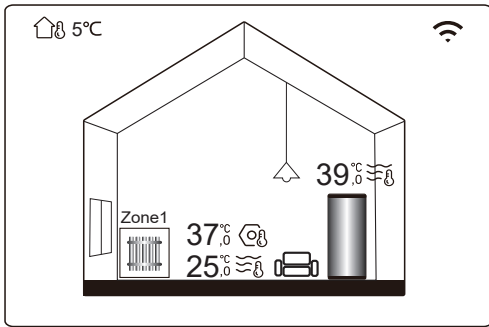

Figure 6. HP290 Standard Curve Graph

1.5 ENABLING CH ZONE 2 (if applicable)

Enable CH zones as follows:



Press and hold \equiv and \rangle together.

Note: TW2 zone 2 thermistor must be clipped to the zone 2 flow pipe for 2 zone operation

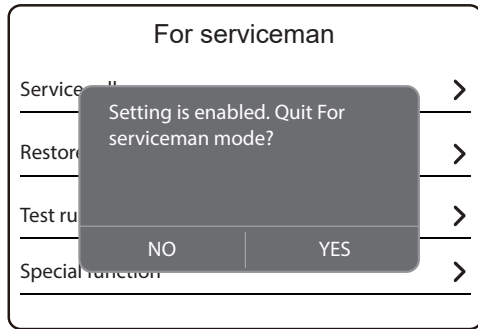

Repeatedly press \equiv to exit the For serviceman menu. Select **YES** to save.

Set Zone 2 for weather compensation as described in Section 1.4.

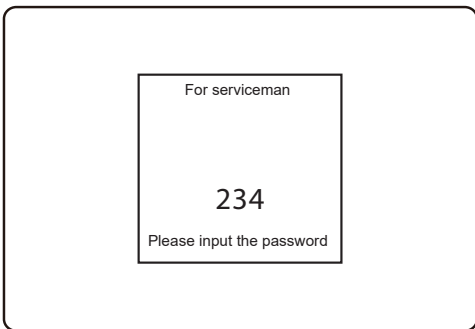

Enter 234

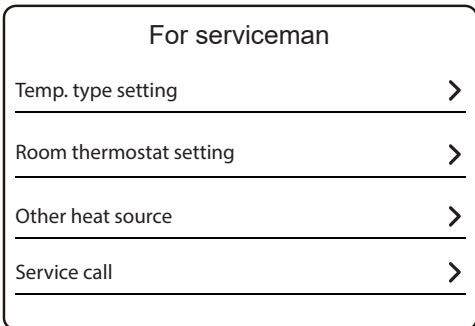

Select **Room thermostat setting**

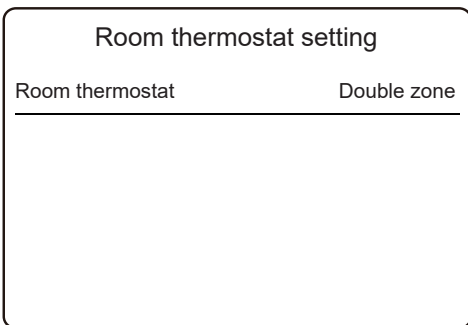

Select **Double zone**

1.5.1 Setting Emitter Type

Set the Emitter Type as follows:

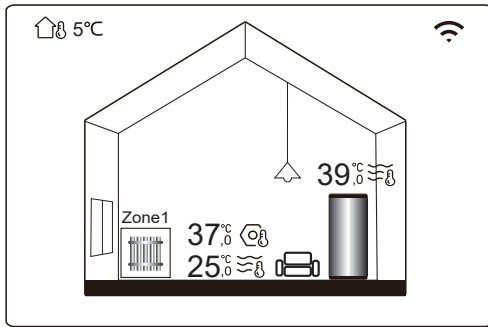

Press and hold \equiv and \rangle together.

Note: TW2 zone 2 thermistor must be clipped to the zone 2 flow pipe for 2 zone operation

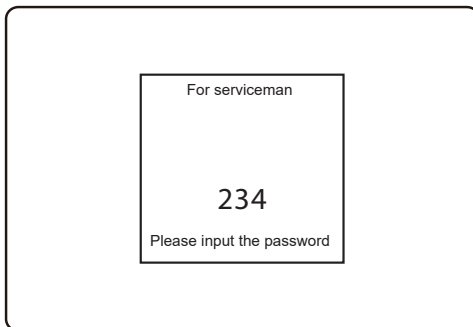

Enter 234

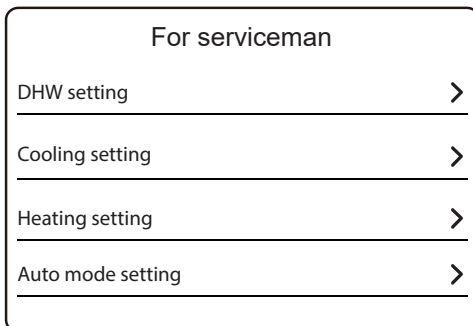

Press \surd twice and select **Heating setting**

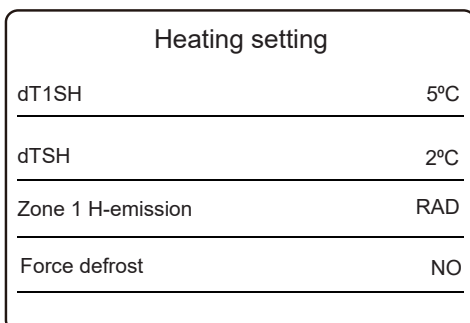

Press \surd until **Zone 1 H-emission** is highlighted then press O.

Press up or down buttons until **RAD** is shown and press O to confirm.

Repeatedly press Select YES to save.

Repeat the above to set Zone 2 H-emission as required.

1.6 OPERATING STATUS

Use the Operating Status display to activate Zones and DHW.

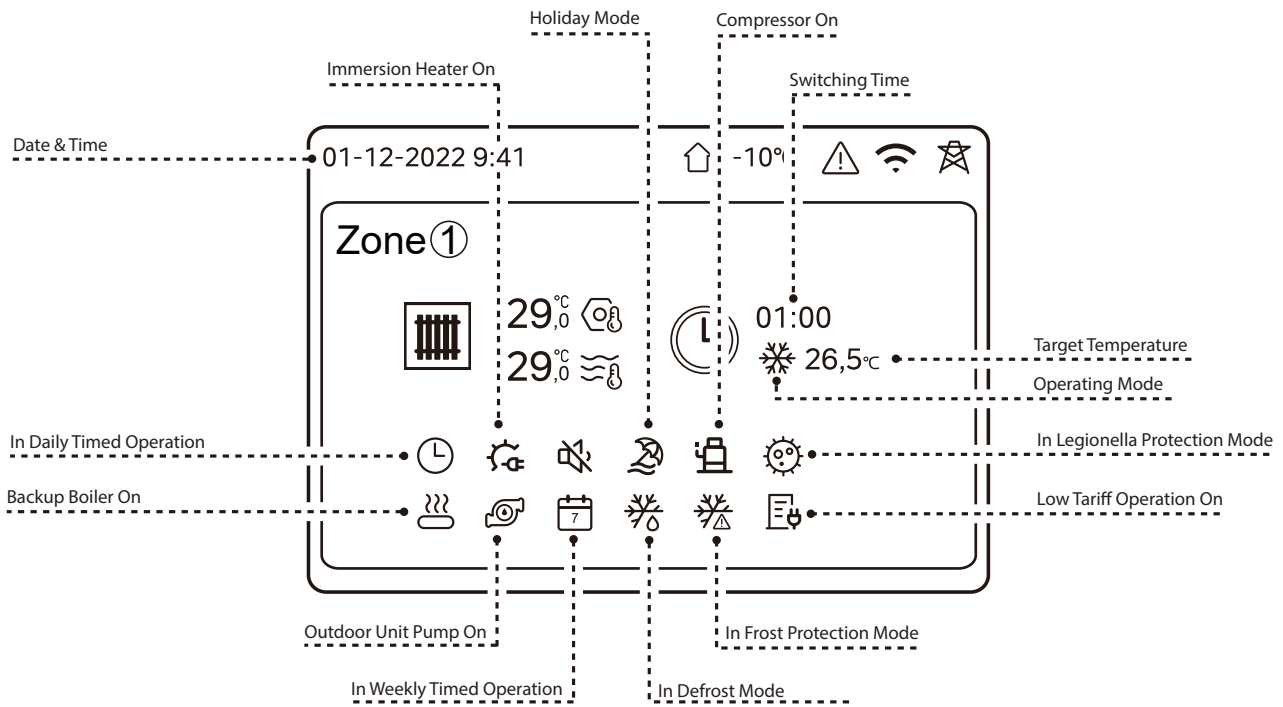

Figure 7. Operating Status Display



At Ideal Heating we take our environmental impact seriously, therefore when installing any Ideal Heating product please make sure to dispose of any previous appliance in an environmentally conscious manner. Households can contact their local authority to find out how. See <https://www.gov.uk/managing-your-waste-an-overview> for guidance on how to efficiently recycle your business waste.

Technical Training

Our Expert Academy offer a range of training options designed and delivered by our experts in heating. For details please visit: expert-academy.co.uk

Ideal Boilers Ltd., pursues a policy of continuing improvement in the design and performance of its products. The right is therefore reserved to vary specification without notice.

Hereby, Ideal Boilers Ltd declares that the radio equipment type (model HP290 Heat Pump System) is in compliance with: Directive 2014/53/EU.

The full text of the EU declaration of conformity is available at the following internet address

idealheating.com/declaration-of-conformity

RF frequency is 2.4000GHz to 2.4835GHz

Max RF output power is less than or equal to 20dBm

Ideal is a trademark of Ideal Boilers.

Registered Office

Ideal Boilers Ltd., National Avenue, Hull, East Yorkshire, HU5 4JB

Tel 01482 492251 Fax 01482 448858

Registration No. London 322 137

EU Authorised Representative:

Atlantic SFDT

44 Boulevard des Etats-Unis, 85 000 La Roche-Sur-Yon, France

+33 (0)2 51 44 34 34

Ideal Technical Helpline: 01482 498663

Ideal Consumer Helpline: 01482 498660

Ideal Parts: 01482 498665

idealheating.com

ideal
HEATING