

SONOMA™

M1 AMPLIFIER QUICK START GUIDE

WARWICK ™  
ACOUSTICS

# 1. CONTENTS

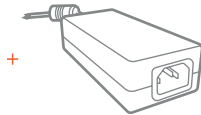
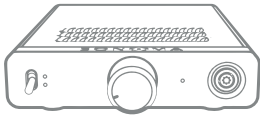
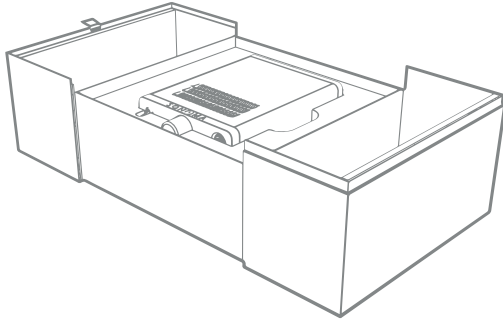

CA



JP



TW



US



AU



CN



NZ



BH



HK



SG



UAE



UK



EU



KR



## 2. CONNECTING TO M1 HEADPHONE

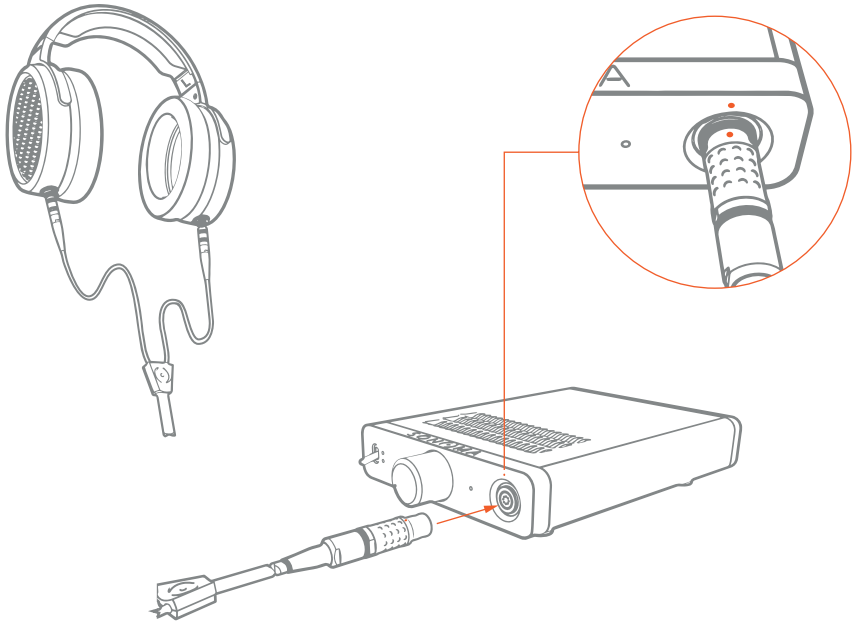

[WWW.WARWICKACOUSTICS.COM/PRODUCTS](http://WWW.WARWICKACOUSTICS.COM/PRODUCTS)  
[WWW.WARWICKACOUSTICS.COM/SUPPORT](http://WWW.WARWICKACOUSTICS.COM/SUPPORT)



SONOMA M1 HP  
ONLY



### 3. SETUP

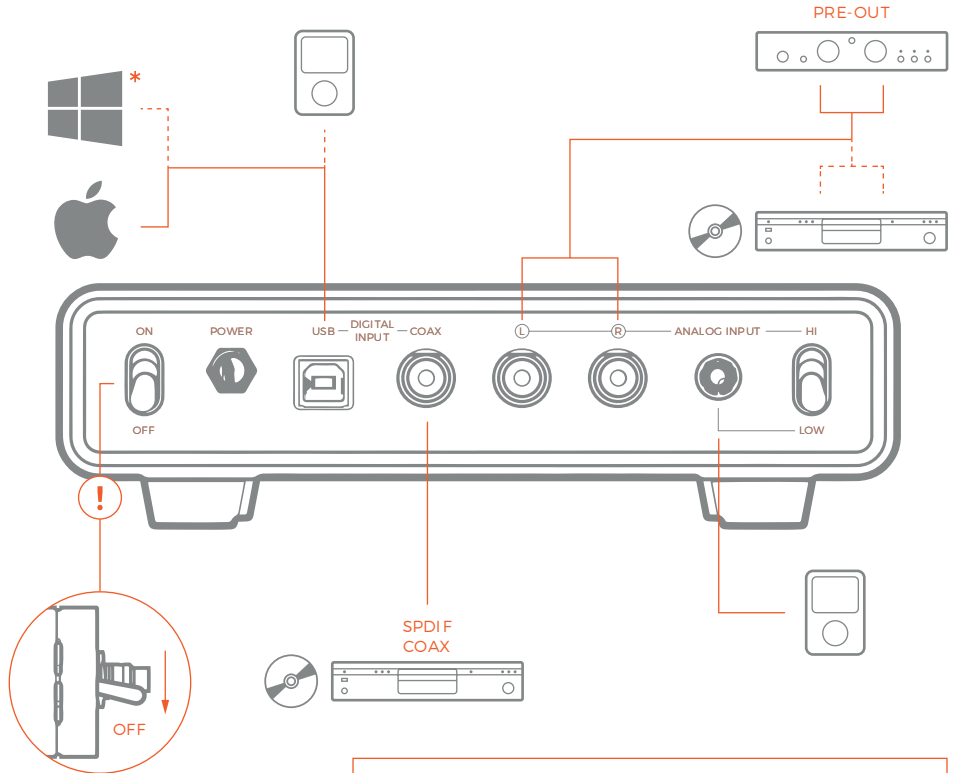

ASIO DRIVER:  
[WWW.WARWICKACOUSTICS.COM/SUPPORT](http://WWW.WARWICKACOUSTICS.COM/SUPPORT)

## 4. INITIALIZE

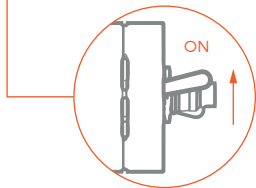
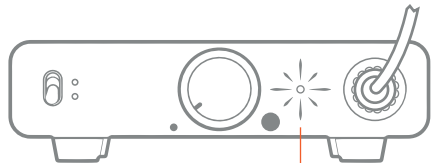
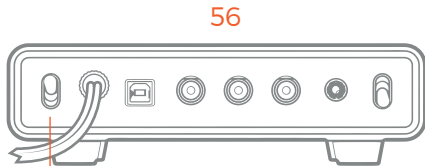
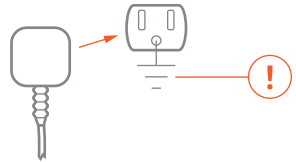
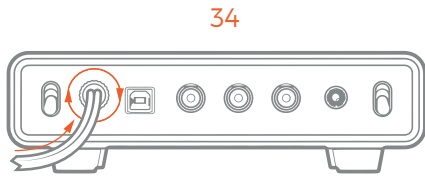
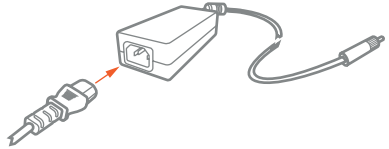
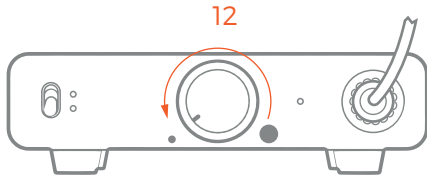

1. CHECK SETUP
2. [WWW.WARWICKACOUSTICS.COM/SUPPORT](http://WWW.WARWICKACOUSTICS.COM/SUPPORT)

# REGULATORY COMPLIANCE STATEMENTS FOR THE MI HEADPHONE AMPLIFIER

## Federal Communications Commission (FCC) Compliance Notices

### Class B Interference Statement

This equipment has been tested and found to comply with the limits for a Class B digital device, pursuant to Part 15, Subpart B of the FCC Rules. These limits are designed to provide reasonable protection against harmful interference in a residential installation. This equipment generates, uses, and can radiate radio frequency energy and, if not installed and used in accordance with the instructions, may cause harmful interference to radio communications. However, there is no guarantee that interference will not occur in a particular installation. If this equipment does cause harmful interference to radio or television reception, which can be determined by turning the equipment off and on, the user is encouraged to try to correct the interference by one or more of the following measures:

- Reorient or relocate the receiving antenna.
- Increase the separation between the equipment and receiver.
- Connect the equipment into an outlet on a circuit different from that to which the receiver is connected.
- Consult the dealer or an experienced radio/TV technician for help.

### FCC Caution:

This device complies with Part 15 of the FCC Rules. Operation is subject to the following two conditions: (1) This device may not cause harmful interference, and (2) this device must accept any interference received, including interference that may cause undesired operation.

### Canadian ICES Statements

Canadian Department of Communications Radio Interference Regulations. This digital apparatus does not exceed the Class B limits for radio-noise emissions from a digital apparatus as set out in the Radio Interference Regulations of the Canadian Department of Communications. This Class B digital apparatus complies with Canadian ICES-003.

Règlement sur le brouillage radioélectrique du ministère des Communications. Cet appareil numérique respecte les limites de bruits radioélectriques visant les appareils numériques de classe B prescrites dans le Règlement sur le brouillage radioélectrique du ministère des Communications du Canada. Cet appareil numérique de la Classe B est conforme à la norme NMB-003 du Canada.

### European Union and European Fair Trade Association (EFTA) Regulatory Compliance

This equipment may be operated in the countries that comprise the member countries of the European Union and the European Fair Trade Association. These countries, listed below, are referred to as The European Community throughout this document: AUSTRIA, BELGIUM, BULGARIA, CYPRUS, CZECH REPUBLIC, DENMARK, ESTONIA, FINLAND, FRANCE, GERMANY, GREECE, HUNGARY, IRELAND, ITALY, LATVIA, LITHUANIA, LUXEMBOURG, MALTA, NETHERLANDS, POLAND, PORTUGAL, ROMANIA, SLOVAKIA, SLOVENIA, SPAIN, SWEDEN, UNITED KINGDOM, ICELAND, LICHTENSTEIN, NORWAY, SWITZERLAND.

### CE Declaration of Conformity

Marking by this symbol indicates compliance with the Essential Requirements of the EMC Directive of the European Union (2014/30/EU). This equipment meets the following conformance statements:

### Safety:

EN 60065: 2002 + A1: 2006 + A11: 2008 + A2: 2010 + A12: 2011 (GS License)

### Also Licensed for Standards:

IEC 60065: 2001 + A1: 2005 + A2: 2010, (CB Scheme Report/Certificate), UL60065: 2003 R7.13 (NRTL License), CAN/CSA-C22.2 No.60065-03 +A1: 06

(R2012) + A2: 12

EN 50332-1: 2000, EN 50332-2: 2003

Emissions:

EN 55032: 2012, CISPR 22: 2008, EN 61000-3-2: 2014, EN 61000-3-3: 2013

Immunity:

EN 55103-2: 2009, EN 61000-4-2: 2009, EN 61000-4-3: 2006 + A1: 2008 + A2: 2010

EN 61000-4-4: 2004 + A1: 2010, EN 61000-4-5: 2006, EN 61000-4-6: 2009, EN 61000-4-11: 2004

Environments: E2, E3 and E4

The products are licensed, as required, for additional country specific standards for the International Marketplace. Additional issued licenses available upon request.

Environmental: Low Voltage Directive 2014/35/EU, RoHS 2011/65/EU, REACH 2006/1907/EC

WEEE 2012/19/EU and Packaging 94/62/EC

### Warning!

This is a Class B product. In a domestic environment, this product may cause radio interference, in which case, the user may be required to take appropriate measures.

### Achtung!

Dieses ist ein Gerät der Funkstörgrenzwertklasse B. In Wohnbereichen können bei Betrieb dieses Gerätes Rundfunkstörungen auftreten, in welchen Fällen der Benutzer für entsprechende Gegenmaßnahmen verantwortlich ist.

### Attention!

Ceci est un produit de Classe B. Dans un environnement domestique, ce produit risque de créer des interférences radioélectriques, il appartiendra alors à l'utilisateur de prendre les mesures spécifiques appropriées.



This symbol on the product or its packaging indicates that this product must not be disposed of with your other household waste. Instead, it is your responsibility to dispose of your waste equipment by handing it over to a designated collection point for the recycling of waste electrical and electronic equipment. The separate collection and recycling of your waste equipment at the time of disposal will help conserve natural resources and ensure that it is recycled in a manner that protects human health and the environment. For more information about where you can drop off your waste for recycling, please contact your local authority, or where you purchased your product.

Please visit the following URL for a complete copy of the declaration of conformity and user manual:

<http://www.warwickacoustics.com/supercat>

This is a Class B product based on the standard of the VCCI Council (VCCI V-3/2015.04). If this equipment is used in a domestic environment, radio interference may occur, in which case, the user may be required to take corrective actions.

この装置は、クラスB情報技術装置です。この装置は、家庭環境で使用することを目的としていますが、この装置がラジオやテレビジョン受信機に近接して使用されると、受信障害を引き起こすことがあります。

取扱説明書に従って正しい取り扱いをして下さい。

VCCI-B