

Taymor®

INSTALLATION INSTRUCTIONS 32-F238 / 32-F238SSS SINGLE SIDED INDICATOR DEADBOLT

For use on doors 1-3/8" to 1-3/4" (35-45 mm) thick

Tools required for new installation:

- Phillips head screwdriver
- 2-1/8" (54 mm) hole saw
- 1" (25.4 mm) drill bit
- Chisel

Tools required for replacement installation:

- Phillips head screw driver

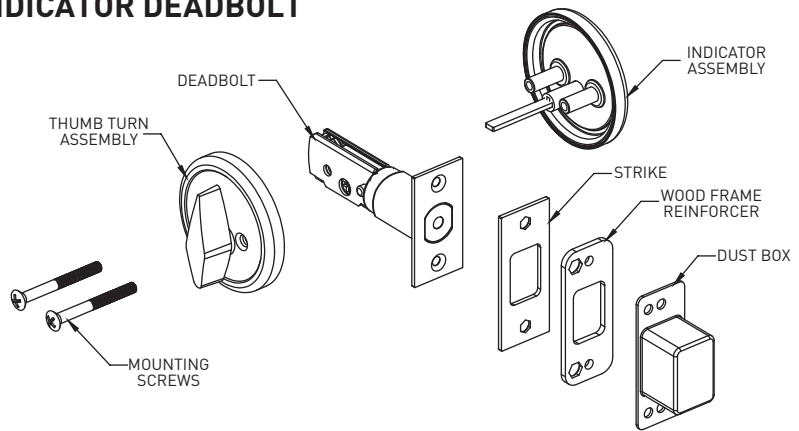

1 MARK DOOR

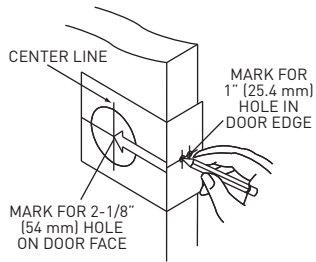

Measure center line of lock; height as desired from finished floor. Select 2-3/4" or optional 2-3/8" backset, fold and apply template to interior side of door and mark center hole on door face through guide on template.

2 DRILL HOLES

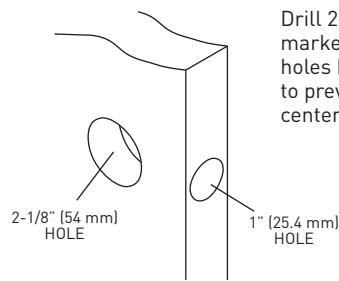

Drill 2-1/8" (54 mm) hole through door face as marked for lockset. (It is recommended that holes be drilled from both sides on wood doors to prevent splitting.) Drill 1" (25.4 mm) hole in center of door edge for latch.

3 INSTALL LATCH

- Insert latch in hole, keeping it parallel to face of door. Mark outline of latch face plate and remove latch.
- Chisel 5/32" (4 mm) deep or until latch plate is flush with door edge.
- Insert latch and tighten to the door using #8 screws.

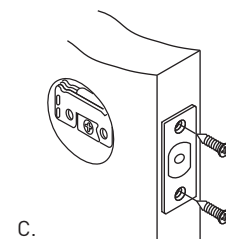
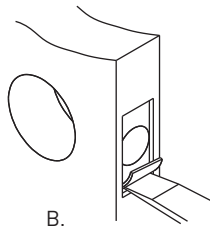
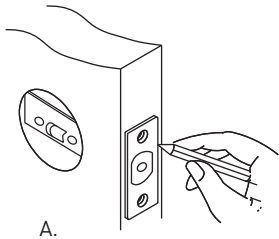

IMPORTANT: Print template to scale if not factory supplied instructions.

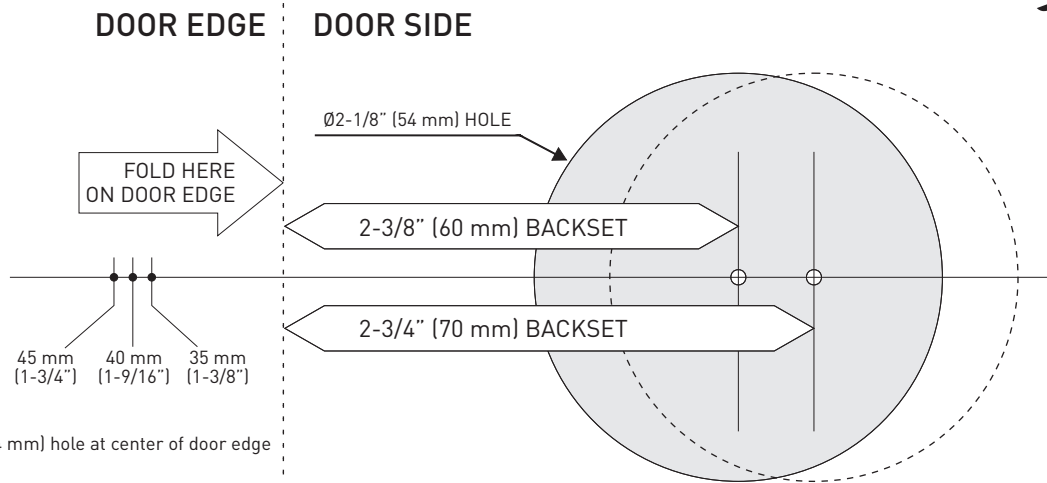
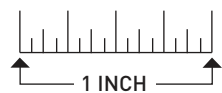

Make 1" (25.4 mm) hole at center of door edge

TEMPLATE

Taymor®

INSTALLATION INSTRUCTIONS (continued) 32-F238 / 32-F238SSS SINGLE SIDED INDICATOR DEADBOLT

4 INSTALL STRIKE

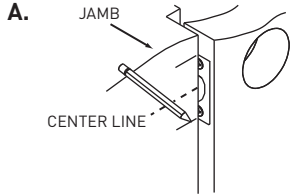

Close door. Locate strike in jamb and center line of strike. Open door and extend line to door stop. Measure half of door thickness plus 1/8" from door stop. Vertically mark centerline for strike.

B.

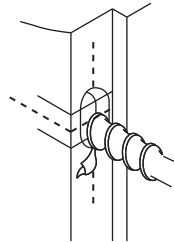

Drill (2) 1" (25.4 mm) holes 1-1/4" (31.7 mm) deep in door jamb, 5/16" (8 mm) above and 5/16" (8 mm) below horizontal center line.

CAUTION:
Hole must be drilled a full 1-1/4" (31.7 mm) deep to ensure proper functioning.

C.

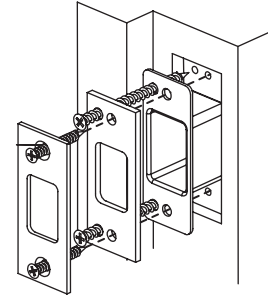

Match screw holes on strike with vertical center lines on jamb. Mark outline of strike and chisel 1/4" (6.4 mm) deep for flush fit of dust box, wood frame reinforcer, and strike. Place dust box and wood frame reinforcer into mortise area and tighten to the frame using 3" wood screws. Insert the strike and tighten to the frame with #8 screws.

5 INSTALL THUMBTURN ASSEMBLY AND BLANK PLATE

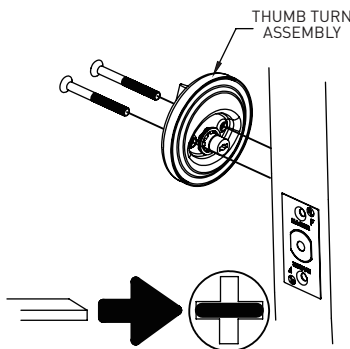

Insert torque blade horizontally into deadbolt latch. Crank until indicator assembly is flush with the door face. Mate the thumbturn assembly with the torque blade on the indicator assembly. Insert the screws through the holes of the thumbturn assembly and latch body. Tighten the screws to the threaded posts of the blank mounting plate. Tighten the assembly so the complete assembly is tight to the door.

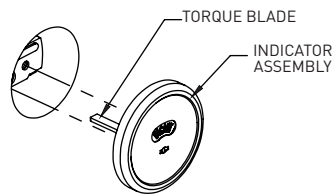

6 BACKSET ADJUSTMENT

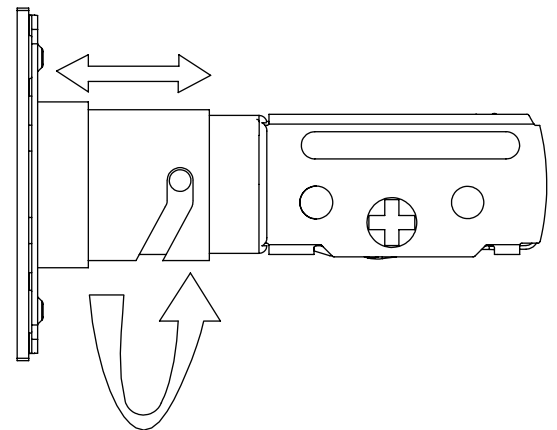

To change deadbolt to a 2-3/8" backset, rotate faceplate 1/2 turn.