



FEATURES

- Universal 6-in-1 latch: drive in, square and radius mortise with adjustable backset: 2-3/8" (60mm) - 2-3/4" (70mm)
- Push button auto-release on privacy function
- Meets ANSI/BHMA A156.2 Grade 3 Standards



INSTALLATION

- Fits standard door thickness: 1-3/8" (35 mm) - 1-3/4" (45 mm)
- Full lip radius corner strike with adjustable tab standard: 1-3/4" x 2-1/4" (45 mm x 57 mm)
- Standard bore holes: 2-1/8" (54 mm)

STOCKED FINISHES

- Polished Chrome 26 (PC)
- Satin Nickel 15 (SN)
- Satin Chrome 26D (SC)

VISUAL PACK	POLISHED CHROME 26	SATIN NICKEL 15	SATIN CHROME 26D
Privacy	31-FV004424PC	31-FV004424SN	31-FV004424SC
Passage	31-FV004434PC	31-FV004434SN	31-FV004434SC

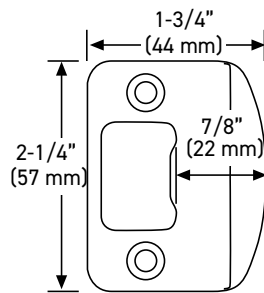
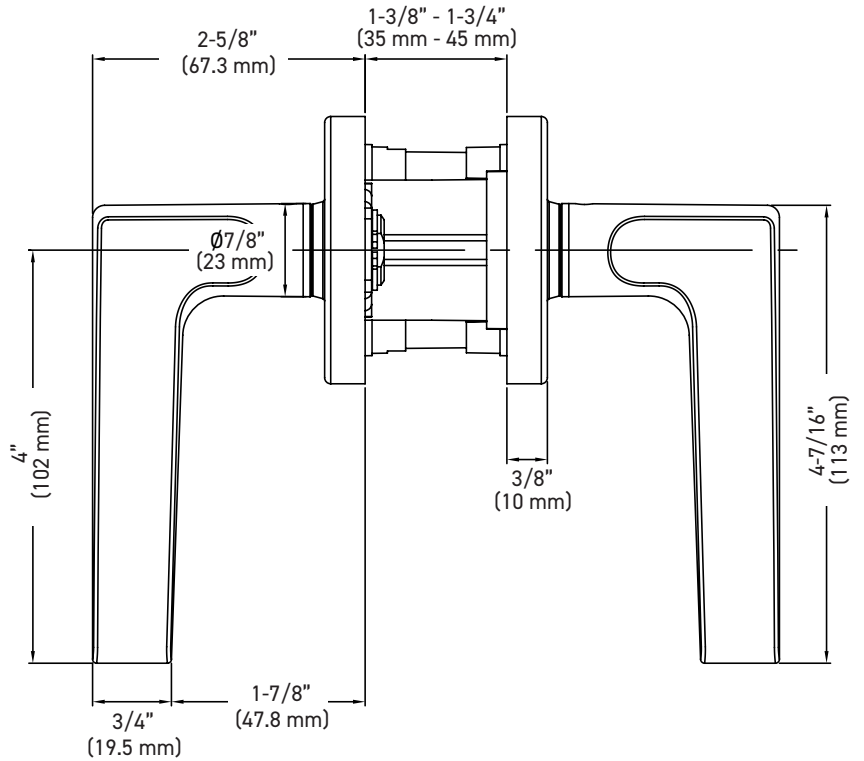
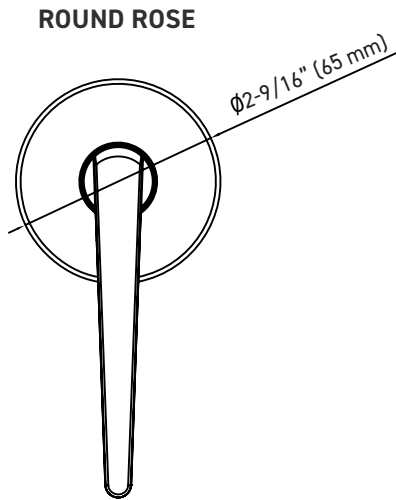

FULL LIP RADIUS STRIKE

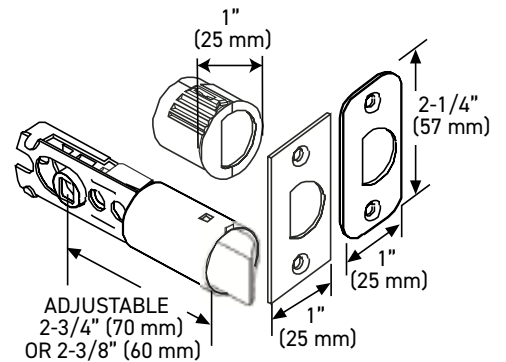

6-IN1 PRIVACY/PASSAGE LATCH

MEASUREMENTS SUBJECT TO A 3% VARIANCE. MEASUREMENTS ARE FOR REFERENCE ONLY. TAYMOR RESERVES THE RIGHT TO CHANGE PRODUCT SPECS WITHOUT NOTICE.