

FEATURES

- INCLUDES SOLID ZINC DIE CAST MOUNTING PLATES: 2-3/16" x 1" [56 mm x 25 mm]; NYLON ANCHORS AND STEEL PHILLIPS HEAD SCREWS: #8 x 1-1/4" [32 mm]
- ZINC DIE-CAST CONSTRUCTION (POSTS)

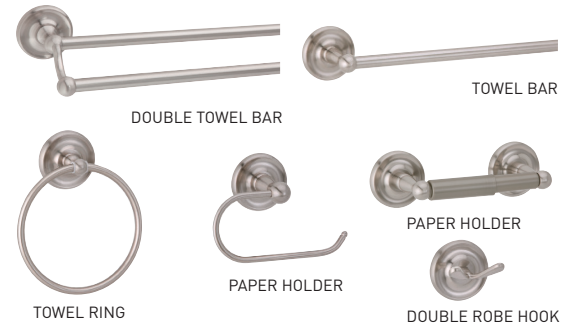

LIMITED LIFETIME WARRANTY



TOWEL BAR

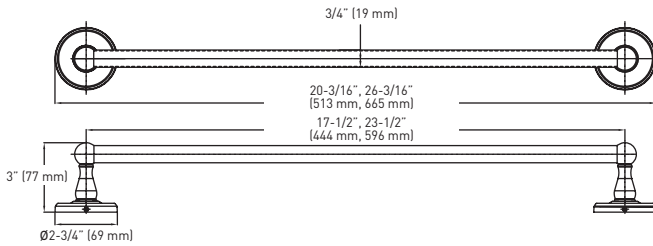

DOUBLE TOWEL BAR

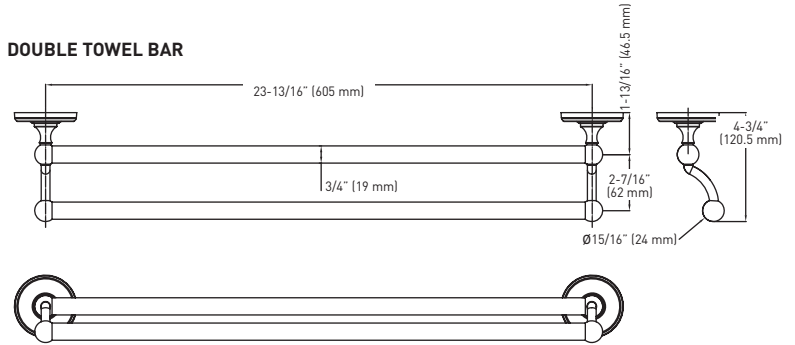

A - PAPER HOLDER

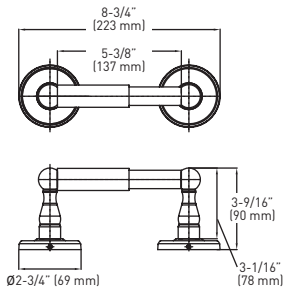

B - PAPER HOLDER

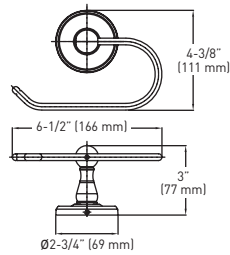

TOWEL RING

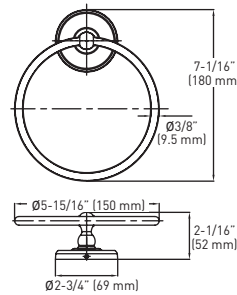

DOUBLE ROBE HOOK

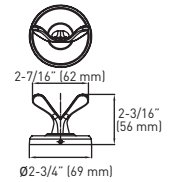

MEASUREMENTS SUBJECT TO A 3% VARIANCE

MEASUREMENTS ARE FOR REFERENCE ONLY. TAYMOR RESERVES THE RIGHT TO CHANGE THE PRODUCT SPECS WITHOUT NOTICE. FOR PRODUCT WARRANTY, PLEASE VISIT TAYMOR WEBSITE FOR DETAILS

RETAIL PACK	SATIN NICKEL 15	POLISHED CHROME 26	MATERIAL	CASE QTY.
TOWEL BAR - 18"	02-D6018SN	02-D6018	ZINC & ALUMINUM	4
TOWEL BAR - 24"	02-D6024SN	02-D6024	ZINC & ALUMINUM	4
DOUBLE TOWEL BAR - 24"	02-D6024DSN	02-D6024D	ZINC & ALUMINUM	4
DOUBLE ROBE HOOK	02-D6002SN	02-D6002	ZINC	4
A - PAPER HOLDER	02-D6008SN	02-D6008	ZINC & PLASTIC	4
B - PAPER HOLDER	02-D6048SN	02-D6048	ZINC	4
TOWEL RING	02-D6004SN	02-D6004	ZINC & ALUMINUM	4



SPÉCIFICATIONS

- COMPREND LES PLAQUES DE MONTAGE EN ZINC MASSIF MOULÉ SOUS PRESSION :
56 mm x 25 mm (2-3/16 po x 1 po), LES DISPOSITIFS D'ANCRAGE EN NYLON ET LES VIS PHILLIPS EN ACIER : NO 8 DE 32 mm (1-1/4 po)
- CONSTRUCTION EN ZINC MOULÉ SOUS PRESSION (SUPPORTS)



GARANTIE
LIMITÉE À VIE

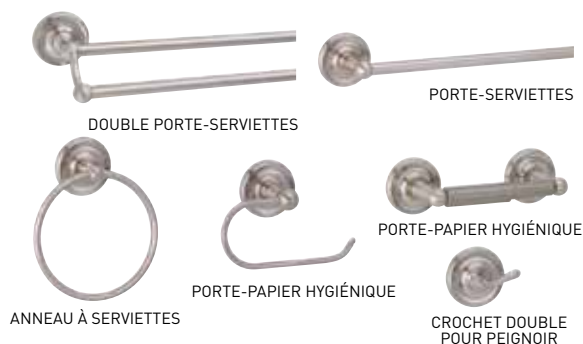

PORTE-SERVIETTE

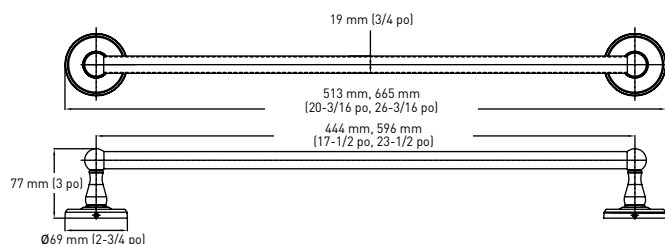

DOUBLE PORTE-SERVIETTES

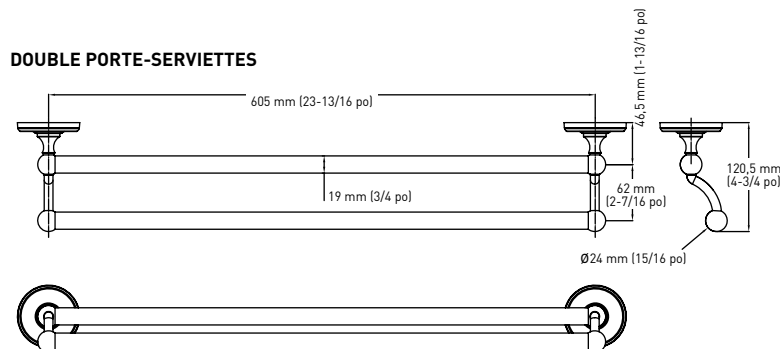

A - PORTE-PAPIER HYGIÉNIQUE

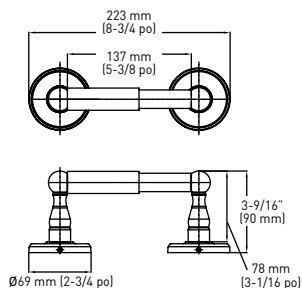

B - PORTE-PAPIER HYGIÉNIQUE

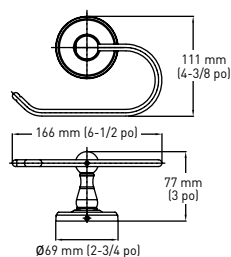

ANNEAU À SERVIETTES

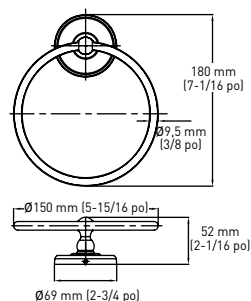

CROCHET DOUBLE POUR PEIGNOIR

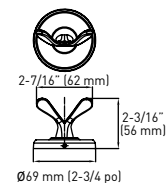

LES MESURES PEUVENT VARIER DE 3 %

LES MESURES SONT PRÉSENTÉES À TITRE DE RÉFÉRENCE SEULEMENT. TAYMOR SE RÉSERVE LE DROIT DE CHANGER LES SPÉCIFICATIONS DU PRODUIT SANS DONNER D'AVIS. POUR CONSULTER LES DÉTAILS DE LA GARANTIE DU PRODUIT, VEUILLEZ VISITER LE SITE WEB DE TAYMOR

EMBALLAGE DE DÉTAIL	NICKEL SATINÉ 15	CHROME POLI 26	MATÉRIAU	QTÉ LA CAISSE
PORTE-SERVIETTES - 18 po	02-D6018SN	02-D6018	ZINC ET ALUMINIUM	4
PORTE-SERVIETTES - 24 po	02-D6024SN	02-D6024	ZINC ET ALUMINIUM	4
DOUBLE PORTE-SERVIETTES - 24 po	02-D6024DSN	02-D6024D	ZINC ET ALUMINIUM	4
CROCHET DOUBLE POUR PEIGNOIR	02-D6002SN	02-D6002	ZINC	4
A - PORTE-PAPIER HYGIÉNIQUE	02-D6008SN	02-D6008	ZINC ET PLATIQUE	4
B - PORTE-PAPIER HYGIÉNIQUE	02-D6048SN	02-D6048	ZINC	4
ANNEAU À SERVIETTES	02-D6004SN	02-D6004	ZINC ET ALUMINIUM	4