

Taymor® | PRODUCT SPECIFICATIONS

THE
PREMIER
LINE

BARCELONA KNOBSET



GRADE
3
ANSI GRADE 3



LIFETIME MECHANICAL & FINISH WARRANTY

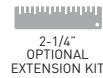

SPECIFICATIONS

- UNIVERSAL 6-IN-1 LATCH: DRIVE IN, SQUARE MORTISE AND RADIUS CORNER WITH ADJUSTABLE BACKSET: 2-3/8" (60 mm) – 2-3/4" (70 mm)
- STANDARD BORE HOLES: 2-1/8" (54 mm)
- FITS STANDARD DOOR THICKNESS: 1-3/8" (35 mm) – 1-3/4" (45 mm)
- FULL LIP RADIUS CORNER STRIKE WITH ADJUSTABLE TAB STANDARD: 1-3/4" x 2-1/4" (45 mm x 57 mm)

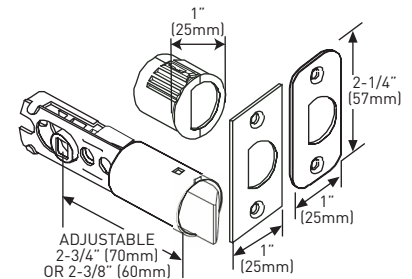
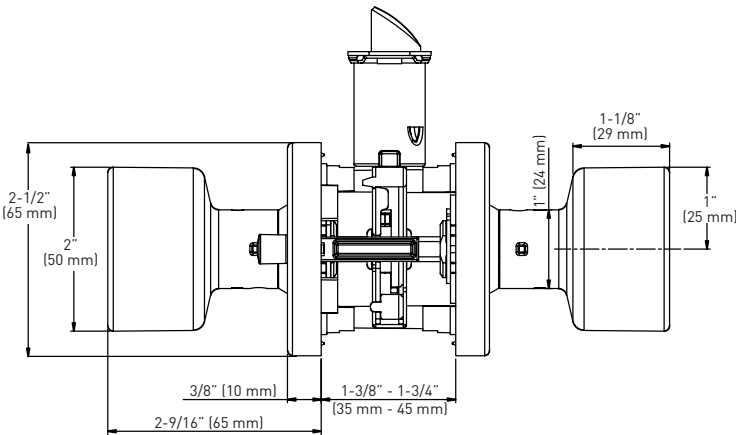

6-IN-1 PRIVACY/PASSAGE LATCH

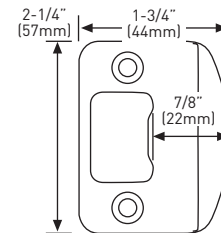
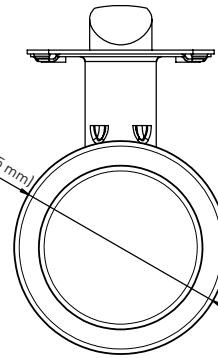

FULL LIP RADIUS STRIKE

BUILDER PACK	SATIN NICKEL 15	MATTE BLACK 19	CASE QTY
Privacy	30-D006124SN	30-D006124BLK	20
Passage	30-D006134SN	30-D006134BLK	20
Inside trim	30-HL0061SN	30-HL0061BLK	20
Dummy	30-614SN	30-614BLK	20

SQUARE ROSE KIT OPTION

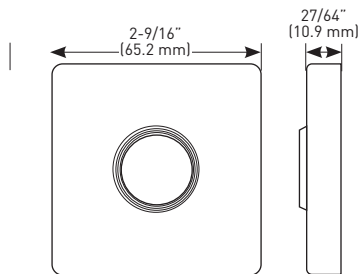

SQUARE CONTEMPORARY ROSE KIT

BUILDER PACK	SATIN NICKEL 15	MATTE BLACK 19	CASE QTY
Privacy	30-SQR0024SN	30-SQR0024BLK	10
Passage	30-SQR0034SN	30-SQR0034BLK	10
Dummy/Inside trim	30-SQR0044SN	30-SQR0044BLK	10

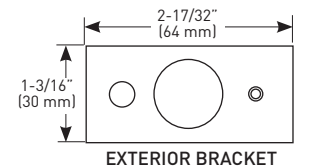
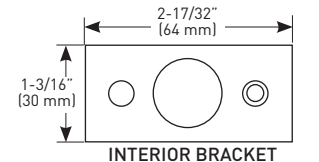

MEASUREMENTS SUBJECT TO A 3% VARIANCE

MEASUREMENTS ARE FOR REFERENCE ONLY. TAYMOR RESERVES THE RIGHT TO CHANGE THE PRODUCT SPECS WITHOUT NOTICE. FOR PRODUCT WARRANTY, PLEASE VISIT TAYMOR WEBSITE FOR DETAILS





QUALITÉ
3

ANSI DE QUALITÉ 3



**GARANTIE À VIE SUR LES COMPOSANTS
MÉCANIQUES ET LA FINITION**



OPTION DE
ENSEMBLE DE
ROSETTE CARRÉE



2-1/4 po
TROUSSE
D'EXTENSION
OFFERTE



RÉSISTANCE AU
FEU DE 20 MINUTES
EN OPTION POUR
CERTAINES
FONCTIONS

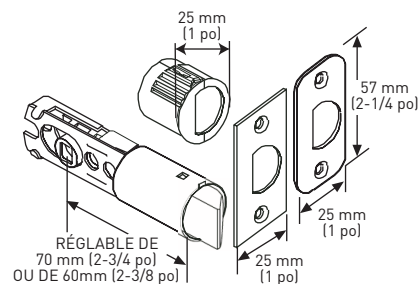
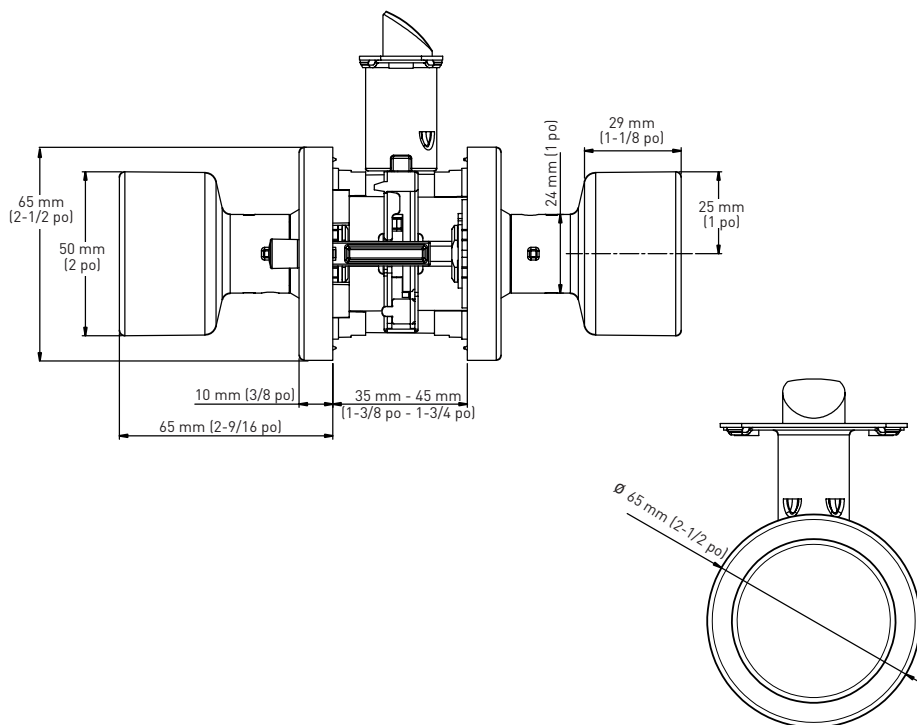

LOQUET 6-EN-1 VERROUILLABLE/NON VERROUILLABLE

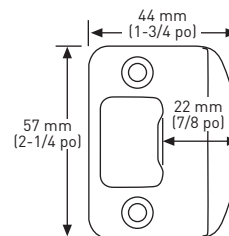

GÂCHE À COINS ARRONDIS AVEC LANGUETTE
PLEINE LARGEUR

EMBALLAGE POUR CONSTRUCTEUR

	NICKEL SATINÉ 15	NOIR MAT 19	QTÉ LA CAISSE
Verrouillable	30-D006124SN	30-D006124BLK	20
Non Verrouillable	30-D006134SN	30-D006134BLK	20
Garniture Intérieure	30-HL0061SN	30-HL0061BLK	20
Fausse Garniture	30-614SN	30-614BLK	20

OPTION DE ENSEMBLE DE ROSETTE CARRÉE

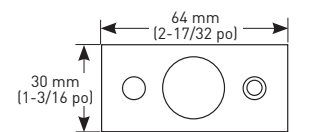
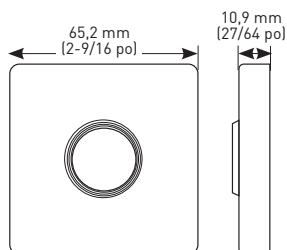

SUPPORT INTÉRIEUR

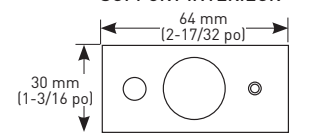

SUPPORT EXTÉRIEUR

ENSEMBLE DE ROSETTE CARRÉE CONTEMPORAINE

EMBALLAGE POUR CONSTRUCTEUR	NICKEL SATINÉ 15	NOIR MAT 19	QTÉ LA CAISSE
Verrouillable	30-SQR0024SN	30-SQR0024BLK	10
Non Verrouillable	30-SQR0034SN	30-SQR0034BLK	10
Fausse Garniture/Garniture Intérieure	30-SQR0044SN	30-SQR0044BLK	10

LES MESURES PEUVENT VARIER DE 3 %

LES MESURES SONT PRÉSENTÉES À TITRE DE RÉFÉRENCE SEULEMENT. TAYMOR SE RÉSERVE LE DROIT DE CHANGER LES SPÉCIFICATIONS DU PRODUIT SANS DONNER D'AVIS. POUR CONSULTER LES DÉTAILS DE LA GARANTIE DU PRODUIT, VEUILLEZ VISITER LE SITE WEB DE TAYMOR