

- › UL AND c-UL LISTED; c-UL10C FOR POSITIVE PRESSURE
- › ANSI A156.4 - GRADE 1
- › CLOSING POWER ADJUSTABLE FROM SIZES 1 TO 6
- › STANDARD BARRIER-FREE OPERATION (COMPLIES WITH ADA)
- › STANDARD BACKCHECK, STANDARD SWEEP AND LATCHING SPEED
- › STANDARD DELAYED ACTION ON 13-1900BFDAAL AND 13-1900BFDABLK MODELS
- › NON-HANDED INSTALLATION
- › CAST ALUMINUM BODY
- › HIGH GRADE QUALITY PLASTIC COVER
- › UNIVERSAL MOUNTING - REGULAR & PARALLEL BRACKET INCLUDED
- › RACK AND PINION MECHANISM
- › STABLE HYDRAULIC FLUID FOR ANY CLIMATE OPERATION & CONSTANT LUBRICATION FROM -42°C TO +55°C



WITHOUT PLASTIC COVER

10 YEAR MECHANICAL AND 1 YEAR FINISH WARRANTY

QUALITY 1
ANSI GRADE 1

c-UL LISTED

MEETS ADA STANDARDS

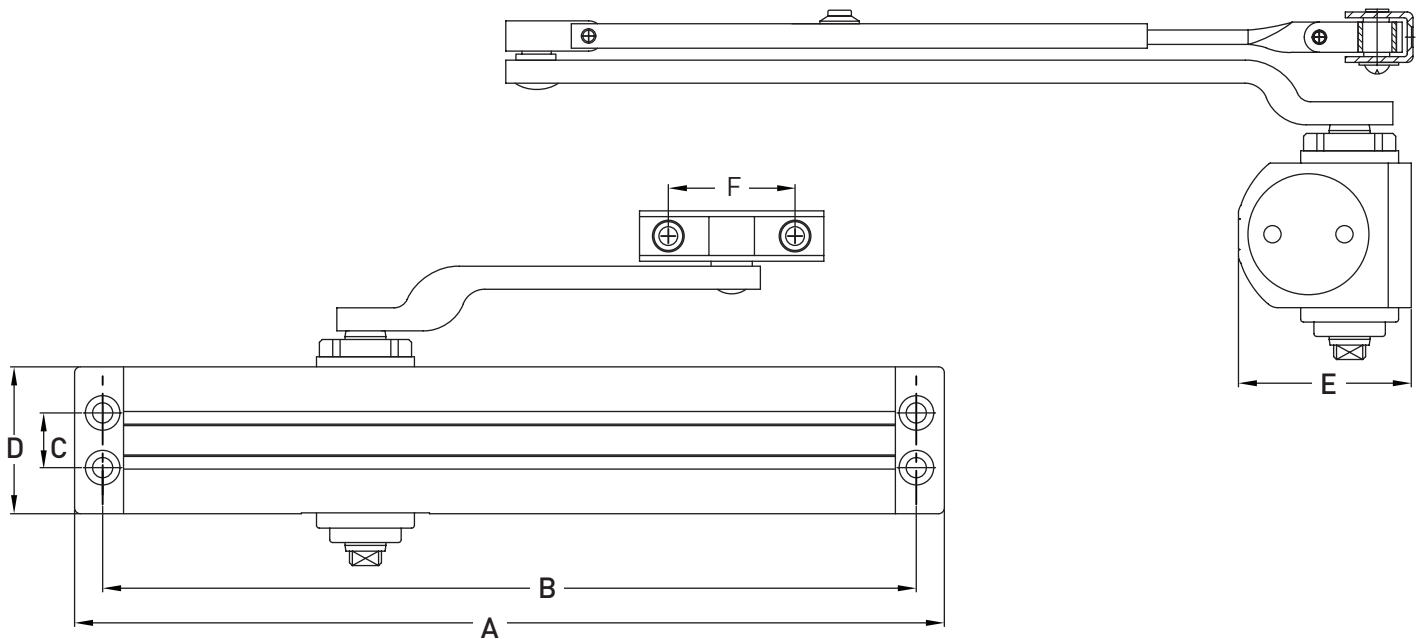







A	B	C	D	E	F
11-7/8" (302 mm)	11-1/8" (282.5 mm)	3/4" (19 mm)	2" (51 mm)	2-3/8" (60 mm)	1-3/4" (44 mm)

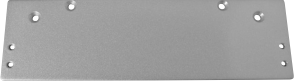

1900 SERIES DOOR CLOSER

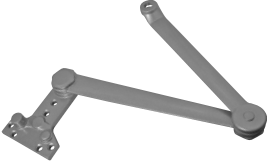
	MAXIMUM RECOMMENDED DOOR SIZE & WEIGHT	MATTE BLACK	ALUMINUM	CASE PACK
ADJUSTABLE POWER 1 THROUGH 6 WITH STANDARD BACKCHECK AND BARRIER FREE	48" x 96" - (121 cm x 243 cm) 266 lbs - (121 kg)	13-1900BLK	13-1900AL	6
ADJUSTABLE POWER 1 THROUGH 6 WITH STANDARD BACKCHECK, BARRIER FREE AND DELAYED ACTION	48" x 96" - (121 cm x 243 cm) 266 lbs - (121 kg)	13-1900BFDABLK	13-1900BFDAAL	6



1900 SERIES DOOR CLOSER ACCESSORIES	DESCRIPTION	MATTE BLACK	ALUMINUM	CASE PACK
	REGULAR OR TOP JAMB NARROW DROP PLATE - 2" TALL (51 mm)	13-A1900DP51BLK	13-A1900DP51AL	10
	PARALLEL ARM DROP PLATE - 3-9/16" TALL (90 mm)	13-A1900DP90BLK	13-A1900DP90AL	10
	PARALLEL ARM BRACKET	13-A1900PABBLK	13-A1900PABAL	10
	CUSH STOP ARM	13-A1900CSABLK	13-A1900CSAAL	10
	CUSH STOP HOLD OPEN ARM MAXIMUM DOOR WEIGHT: 60 KG (132 LBS)	13-A1900CSHOABLK	13-A1900CSHOAAL	10
	EXTENDED LONG ROD AND SHOE	13-A1900ELRSBLK	13-A1900ELRSAL	50
	THRU BOLTS	13-A1900SNBBLK	13-A1900SNBAL	10
	SCREW PACK	13-A1900SPBLK	13-A1900SPAL	10

- › HOMOLOGUÉ UL ET cUL ET CONFORME À LA NORME DE PRESSION POSITIVE cUL10
- › ANSI A156.4 DE QUALITÉ 1
- › FORCE DE FERMETURE RÉGLABLE POUR LES TAILLES 1 À 6
- › FONCTIONNEMENT À ACCÈS FACILE STANDARD (CONFORME À ADA)
- › FREINAGE À L'OUVERTURE STANDARD, VITESSE DE FERMETURE ET DE VERROUILLAGE STANDARD
- › ACTION RETARDÉE STANDARD SUR LE MODÈLES 13-1900BFDAAL ET 13-1900BFDABLK
- › INSTALLATION RÉVERSIBLE
- › BOÎTIER EN ALUMINIUM MOULÉ
- › COUVERCLE DE PLASTIQUE DE QUALITÉ SUPÉRIEURE
- › MONTAGE UNIVERSEL (SUPPORTS ORDINAIRE ET PARALLÈLE INCLUS)
- › MÉCANISME DE CRÉMAILLÈRE ET DE PIGNON
- › FLUIDE HYDRAULIQUE STABLE POUR UN FONCTIONNEMENT DANS TOUTES LES CONDITIONS CLIMATIQUES ET POUR UNE LUBRIFICATION CONSTANTE DE -42 °C À +55 °C



SANS COUVERCLE DE PLASTIQUE

GARANTIE DE 10 ANS SUR LES COMPOSANTS MÉCANIQUES ET DE 1 AN SUR LA FINITION



ANSI QUALITÉ 1



HOMOLOGUÉ



RÉPOND AUX NORMES ADA

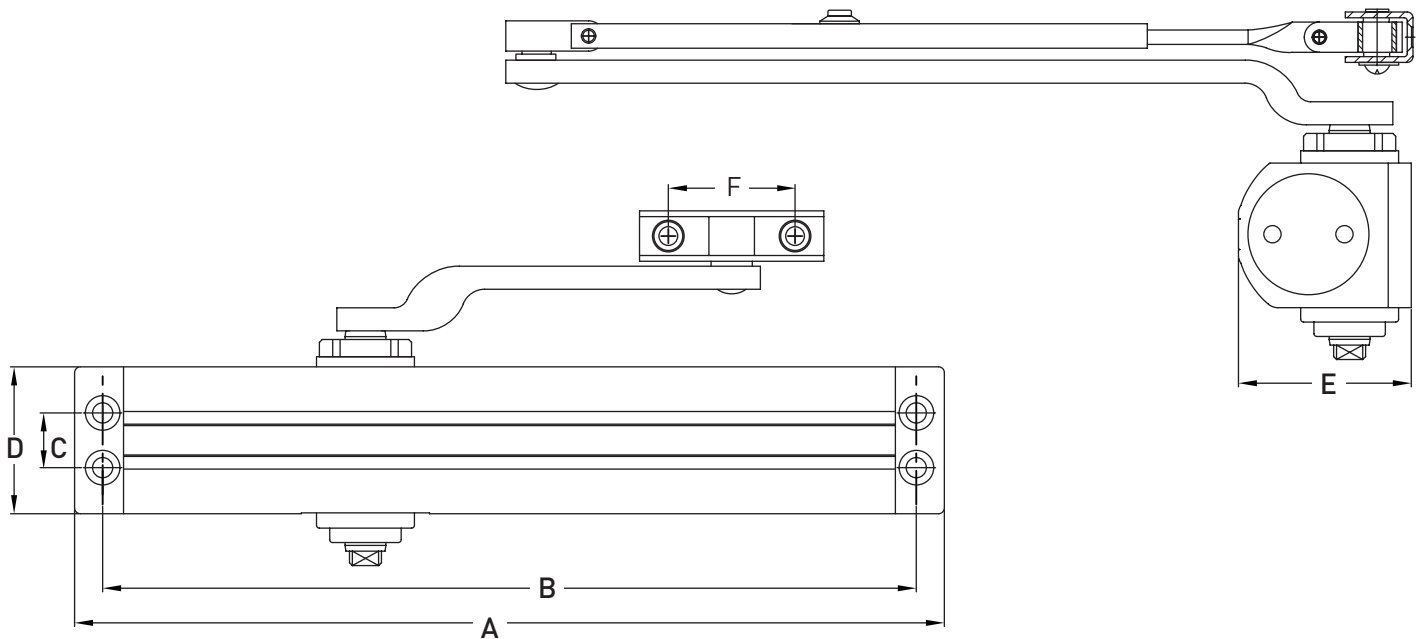

A	B	C	D	E	F
302 mm (11-7/8 po)	282,5 mm (11-1/8 po)	19 mm (3/4 po)	51 mm (2 po)	60 mm (2-3/8 po)	44 mm (1-3/4 po)



FERME-PORTE DE SÉRIE 1900

FORCE RÉGLABLE 1 À 6 AVEC FREINAGE À L'OUVERTURE ET ACCÈS FACILE STANDARD

DIMENSION ET POIDS MAXIMUMS RECOMMANDÉS DES PORTES

NOIR MAT

ALUMINIUM

QTÉ LA CAISSE

121 cm x 243 cm - (48" x 96")
121 kg - (266 lbs)

13-1900BLK

13-1900AL

6

FORCE RÉGLABLE 1, À 6 AVEC FREINAGE À L'OUVERTURE, ACCÈS FACILE ET ACTION RETARDÉE STANDARD







121 cm x 243 cm - (48 po x 96 po)
121 kg - (266 lbs)

13-1900BFDABLK

13-1900BFDAAL

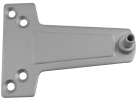
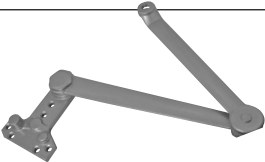
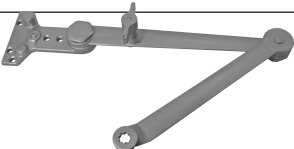
6

ACCESSOIRES POUR FERME-PORTE DE SÉRIE 1900

	DESCRIPTION	NOIR MAT	ALUMINIUM	QTÉ LA CAISSE
	CALE DE FERME-PORTE ÉTROITE POUR MONTAGE SUR MONTANT SUPÉRIEUR OU ORDINAIRE - HAUTEUR DE 51 mm (2 po)	13-A1900DP51BLK	13-A1900DP51AL	10
	CALE DE FERME-PORTE POUR BRAS PARALLÈLE - HAUTEUR DE 90 mm (3-9/16 po)	13-A1900DP90BLK	13-A1900DP90AL	10
	SUPPORT DE BRAS PARALLÈLE	13-A1900PABBLK	13-A1900PABAL	10
	BRAS D'AMORTISSEMENT	13-A1900CSABLK	13-A1900CSAAL	10
	BRAS DE RETENUE ET D'AMORTISSEMENT MAXIMUM: 60 KG POIDS DE PORTE (132 LBS)	13-A1900CSHOABLK	13-A1900CSHOAAL	10
	TIGE LONGUE ALLONGÉE ET ATTACHE	13-A1900ELRSBLK	13-A1900ELRSAL	50
	BOULONS TRAVERSANTS	13-A1900SNBBLK	13-A1900SNBAL	10
	PAQUET DE VIS	13-A1900SPBLK	13-A1900SPAL	10