



FEATURES

- Universal 6-in-1 latch: drive in, square and radius mortise with adjustable backset: 2-3/8" (60mm) - 2-3/4" (70mm)
- Push button auto-release on privacy function
- Meets ANSI/BHMA A156.2 Grade 3 Standards

INSTALLATION

- Fits standard door thickness: 1-3/8" (35 mm) - 1-3/4" (45 mm)
- Full lip radius corner strike with adjustable tab standard: 1-3/4" x 2-1/4" (45 mm x 57 mm)
- Standard bore holes: 2-1/8" (54 mm)

STOCKED FINISHES

- Polished Chrome 26 (PC)
- Matte Black 19 (BLK)
- Satin Nickel 15 (SN)

SPECIAL ORDER FINISHES

- Satin Brass 4 (SB)
- Dark Bronze 10B (DB)
- Gun Metal (GM)
- Satin Stainless 32D (SS)



ROUND ROSE



SQUARE ROSE

BOX PACK	POLISHED CHROME 26	MATTE BLACK 19	SATIN NICKEL 15
ROUND ROSE			
Privacy	30-D007424PC	30-D007424BLK	30-D007424SN
Passage	30-D007434PC	30-D007434BLK	30-D007434SN
Dummy	30-744PC	30-744BLK	30-744SN
SQUARE ROSE			
Privacy	30-D007524PC	30-D007524BLK	30-D007524SN
Passage	30-D007534PC	30-D007534BLK	30-D007534SN
Dummy	30-754PC	30-754BLK	30-754SN

HOW TO SPECIFY SPECIAL ORDER FINISHES

Please contact your Taymor Sales Representative for pricing, samples, and minimum order quantities.

To determine the item code for a special order finish product, simply add the finish code at the end of the product SKU as shown below:

FINISH	FINISH CODE
Satin Brass 4	SB
Dark Bronze 10B	DB
Gun Metal	GM
Polished Chrome 26	PC
Matte Black 19	BLK
Satin Nickel 15	SN
Satin Stainless 32D	SS
Satin Chrome 26D	SC

30	-	D006464	SB
LINE CODE		SKU	FINISH CODE

30-D006464SB

Example of the item codes for the Vega Round Rose Lever in Satin Brass:

FUNCTIONS	LINE CODE	SKU	FINISH CODE	ITEM CODE
Privacy	30	D006424	SB	30-D006424SB
Passage 🔥	30	D006434	SB	30-D006434SB
Inside Trim	30	HL0064	SB	30-HL0064SB
Dummy	30	644	SB	30-644SB

ADDITIONAL DETAILS

- Special order products are not eligible for return or exchange
- Lead times September vary
- Minimum order quantities apply

ROUND ROSE

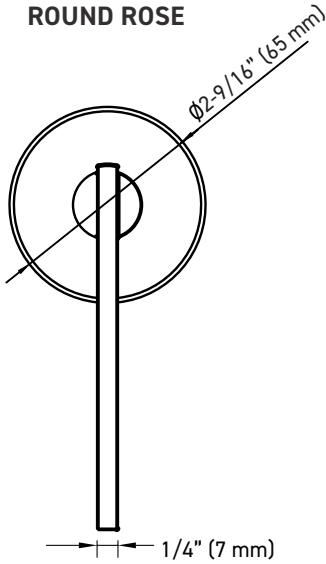

SQUARE ROSE

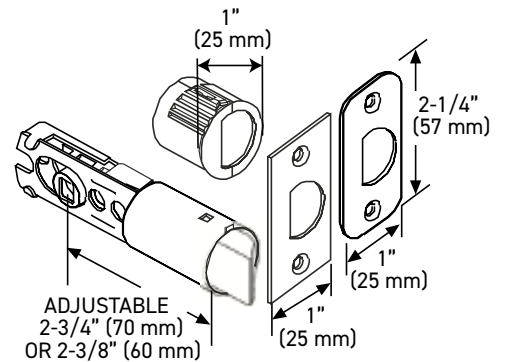
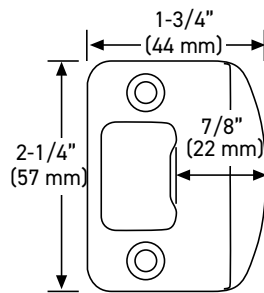
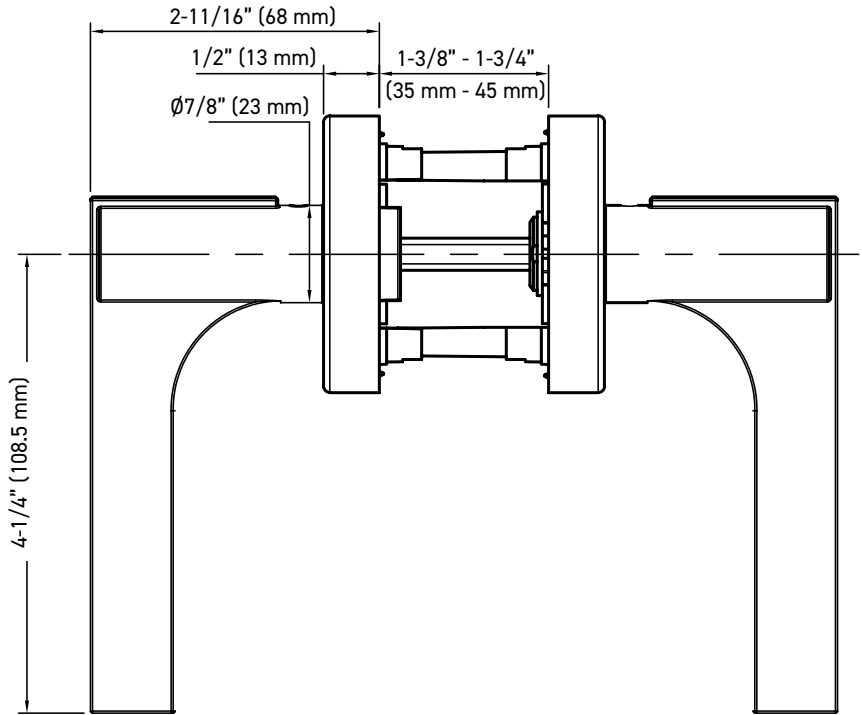
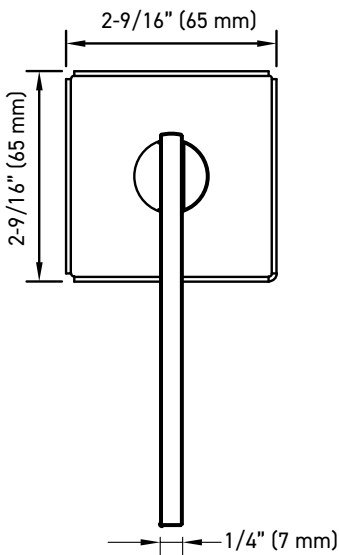

FULL LIP RADIUS STRIKE

6-IN1 PRIVACY/PASSAGE LATCH

MEASUREMENTS SUBJECT TO A 3% VARIANCE. MEASUREMENTS ARE FOR REFERENCE ONLY. TAYMOR RESERVES THE RIGHT TO CHANGE PRODUCT SPECS WITHOUT NOTICE.