

- › UL AND c-UL LISTED; UL10C FOR POSITIVE PRESSURE
- › ANSI A156.4 - GRADE 1
- › CLOSING POWER ADJUSTABLE FROM SIZES 1 TO 6
- › STANDARD BARRIER-FREE OPERATION (COMPLIES WITH ADA)
- › STANDARD BACKCHECK, STANDARD SWEEP AND LATCHING SPEED
- › STANDARD DELAYED ACTION ON 13-1900BFDAAL AND 13-1900BFDABLK MODELS
- › NON-HANDED INSTALLATION
- › CAST ALUMINUM BODY
- › HIGH GRADE QUALITY PLASTIC COVER
- › UNIVERSAL MOUNTING - REGULAR & PARALLEL BRACKET INCLUDED
- › RACK AND PINION MECHANISM
- › STABLE HYDRAULIC FLUID FOR ANY CLIMATE OPERATION & CONSTANT LUBRICATION FROM -42°C TO +55°C



WITHOUT PLASTIC COVER

10 YEAR MECHANICAL AND 1 YEAR FINISH WARRANTY

QUALITY  
1  
ANSI GRADE 1

UL  
LISTED

MEETS ADA  
STANDARDS

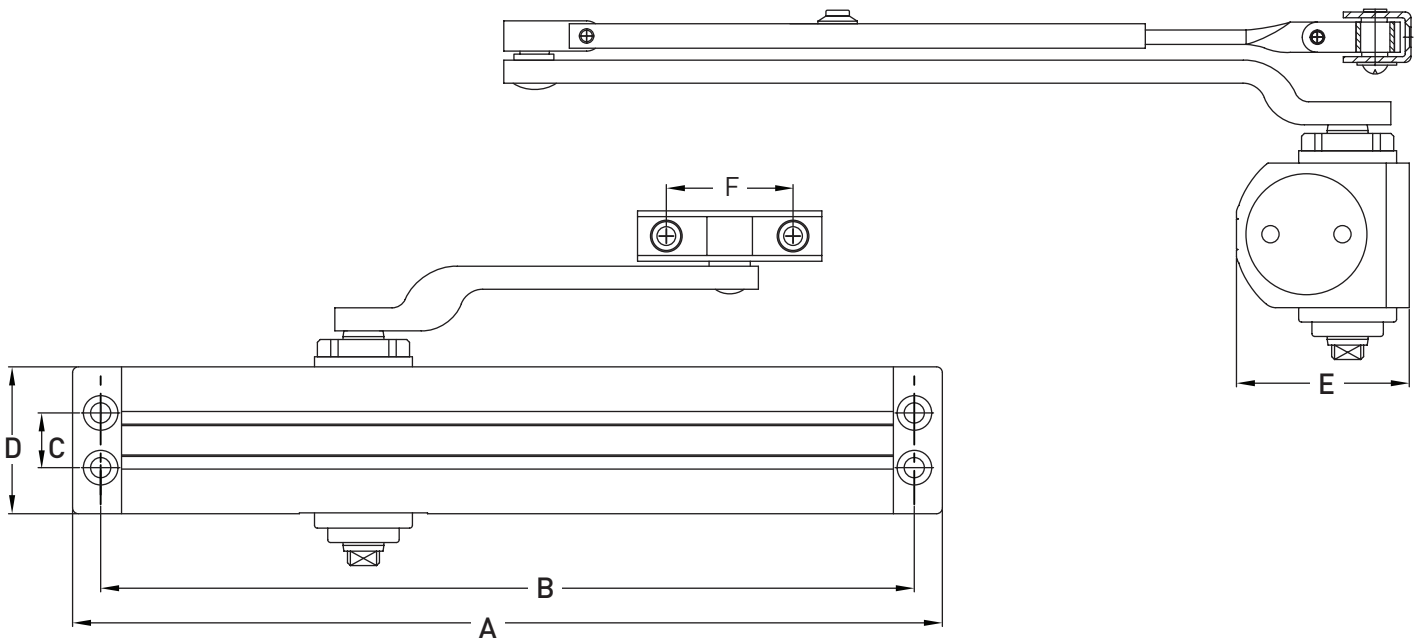







A	B	C	D	E	F
11-7/8" (302 mm)	11-1/8" (282.5 mm)	3/4" (19 mm)	2" (51 mm)	2-3/8" (60 mm)	1-3/4" (44 mm)

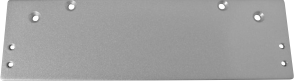

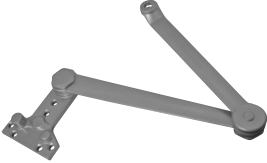
### 1900 SERIES DOOR CLOSER

	MAXIMUM RECOMMENDED DOOR SIZE & WEIGHT	MATTE BLACK	ALUMINUM	CASE PACK
ADJUSTABLE POWER 1 THROUGH 6 WITH STANDARD BACKCHECK AND BARRIER FREE	48" x 96" - (121 cm x 243 cm) 266 lbs - (121 kg)	13-1900BLK	13-1900AL	6
ADJUSTABLE POWER 1 THROUGH 6 WITH STANDARD BACKCHECK, BARRIER FREE AND DELAYED ACTION	48" x 96" - (121 cm x 243 cm) 266 lbs - (121 kg)	13-1900BFDABLK	13-1900BFDAAL	6

1900 SERIES DOOR CLOSER ACCESSORIES	DESCRIPTION	MATTE BLACK	ALUMINUM	CASE PACK
	REGULAR OR TOP JAMB NARROW DROP PLATE - 2" TALL (51 mm)	13-A1900DP51BLK	13-A1900DP51AL	10
	PARALLEL ARM DROP PLATE - 3-9/16" TALL (90 mm)	13-A1900DP90BLK	13-A1900DP90AL	10
	PARALLEL ARM BRACKET	13-A1900PABBLK	13-A1900PABAL	10
	CUSH STOP ARM	13-A1900CSABLK	13-A1900CSAAL	10
	CUSH STOP HOLD OPEN ARM MAXIMUM DOOR WEIGHT: 60 KG (132 LBS)	13-A1900CSHOABLK	13-A1900CSHOAAL	10
	EXTENDED LONG ROD AND SHOE	13-A1900ELRSBLK	13-A1900ELRSAL	50
	THRU BOLTS	13-A1900SNBBLK	13-A1900SNBAL	10
	SCREW PACK	13-A1900SPBLK	13-A1900SPAL	10