

User manual

Vacuclave® 105

Steam sterilizer

from software version 2.11.4



EN

Dear customer,

We thank you for your confidence demonstrated by the purchase of this MELAG product. As an owner-run and operated family concern founded in 1951, we have a long history of successful specialization in hygiene products for practice-based use. Our focus on innovation, quality and the highest standards of operational reliability has established MELAG as the world's leading manufacturer in the instrument reprocessing and hygiene field.

You, our customer are justified in your demand for the best products, quality and reliability. Providing **“competence in hygiene”** and **“Quality – made in Germany”**, we guarantee that these demands will be met. Our certified quality management system is subject to close monitoring: one instrument to this end is our annual multi-day audit conducted in accordance with EN ISO 13485. This guarantees that all MELAG products are manufactured and tested in accordance with strict quality criteria.

The MELAG management and team.

CE 0197

Contents

1 General guidelines	5	Resetting the maintenance counter	28
Symbols used	5	Record of installation	28
Formatting rules	5	7 Important information for routine operation	29
Disposal	5	Feed water and wastewater containers	29
2 Safety	6	8 Sterilization	31
3 Performance specifications	7	Preparing the load	31
Intended use	7	Reprocessing instruments	31
Sterilization procedure	7	Reprocessing textiles	31
Type of the feed water supply	7	Loading the steam sterilizer	32
Program runs	7	Closed sterile containers	32
Safety equipment	8	Soft sterilization packaging	32
Performance characteristics of sterilization programs	9	Multiple wrapping	32
4 Description of the device	10	Mixed loads	33
Scope of delivery	10	Loading volumes	33
Views of the device	11	Selecting the program	33
Symbols on the device	12	Starting the program	35
Touch display	13	Program options	35
LED display and acoustic signals	16	Program in progress	37
5 Installation requirements	17	Program is ended	37
Installation location	17	Ending the program prematurely	38
Electromagnetic environments	17	Manual program abort	39
Space requirements	18	Removing the sterile material	41
Mains connection	19	Storing sterile material	42
System and network safety	19	9 Logging	43
Operating the device with memory media	20	Batch documentation	43
Operating the device in the local network (LAN)	20	Logs menu	43
Network bandwidth/Quality of Service (QoS)	21	Subsequent log output	44
6 Setup and installation	22	Output media	45
Removing from the packaging	22	Displaying logs on the computer	46
Setting the water supply and disposal	22	10 Function checks	47
Manual water supply and disposal	22	Service programs	47
Automatic water supply and disposal	23	Vacuum test	47
Connecting the mains cable	24	Steam penetration test	48
Aligning the device	25	11 Settings	50
Switching on the device	26	General settings	51
Opening and closing the door	26	Language	51
Opening the door	27	Date	51
Close the door	27	Time	52
Checking the software version	28	Display	53
Checking date and time	28	Audio	54
Setting the display and audio	28	Energy saving	54
Test runs	28	Dust filter	56
Instructing the users	28	Log output	57



Drying (flexDRY)	64	13 Pause times	75
Network	65	Frequency of sterilization	75
Administrative settings	67	Duration of the operating pause	75
Log in as an administrator or service technician	67	Decommissioning	75
Logging out as an administrator	67	Transport	75
Admin PIN	68	Symbols on the packaging	75
Checking the software version	69	On-site transport	76
Software update	69	Off-site transport	76
Country parameters	70	Recommissioning after relocation	76
12 Maintenance	71	14 Malfunctions	77
Maintenance intervals	71	Malfunction logs	78
Cleaning	71	Warning and malfunction messages	78
Sterilization chamber, door seal, inner door surface, trays	71	Manual door emergency-opening	80
Housing parts	72	15 Technical data	82
Feed water and wastewater containers	72	16 Components, accessories and spare parts	83
Avoiding staining	72	17 Technical tables	85
Replacing the sterile filter	73	Feed water quality	85
Replacing the door seal	73	Nominal value tolerances	85
Replacing the dust filter	74	Empty chamber test	86
Replacing hoses	74	Pressure-time chart	86
Maintenance	74	Glossary	88

1 General guidelines



Please read this user manual carefully before commissioning the device. The manual includes important safety instructions. Make sure that you always have access to digital or printed version of the user manual.

Should the manual no longer be legible, is damaged or has been lost, you can download a new copy from MELAG download centre at www.melag.com.

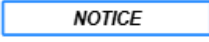
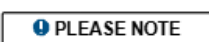
Symbols used

Symbol	Description
 WARNING	Indicates a dangerous situation, which if not avoided, could entail slight to life-threatening injuries.
 CAUTION	Indicates a dangerous situation, which if not avoided, could entail slight to moderate injuries.
 NOTICE	Indicates a dangerous situation, which if not avoided, could result in damage to the instruments, the practice fittings or the device.
 PLEASE NOTE	Draws your attention to important information.

Formatting rules

Example	Description
see Chapter 2	Reference to another text section within this document.
Universal B	Words or phrases appearing on the display of the device are marked as display text.
	Prerequisites for the following handling instruction.
	Reference to the glossary or another text section.
	Information for safe handling.

Disposal

MELAG devices are synonymous with long-term quality. When you eventually need to decommission your MELAG device, the required disposal of the device can be carried out by MELAG in Berlin. Simply contact your stockist.

Dispose of ▶[components](#), spare parts, ▶[accessories](#), ▶[equipment](#) and consumables that you no longer need properly. Comply with all relevant disposal regulations regarding potentially contaminated waste.

The packaging protects the device against transport damage. The packaging materials have been selected for their environmentally-friendly and recycling properties and can be recycled. Returning the packaging to the material cycle reduces the amount of waste and saves raw materials.

MELAG draws the operator's attention to the fact that they are responsible for deleting personal data on the device to be disposed of.

MELAG draws the operator's attention to the fact that they may be legally obliged (e.g. in Germany according to ElektroG) to remove used batteries and accumulators non-destructively before handing over the device, provided they are not enclosed in the device.

2 Safety



When operating the device, comply with the following safety instructions as well as those contained in subsequent chapters. Use the device only for the purpose specified in these instructions. Failure to comply with the safety instructions can result in injury and/or damage to the device.

Qualified personnel

- As with the preceding instrument reprocessing, only ▶[competent personnel](#) should undertake sterilization using this steam sterilizer.
- The operator must ensure that the users are regularly trained in the operation and safe handling of the device.

Opening the housing

- Never open the device housing. Incorrect opening and repair can compromise electrical safety and pose a danger to the user. The device may only be opened by an ▶[authorised technician](#) who must be a ▶[qualified electrician](#).

Notification requirement in the event of serious incidents in the European Economic Area

- Please note that all series incidents that occur in relation to a ▶[medical device](#) (e.g. death or a serious deterioration in a patient's state of health), which were presumably caused by the device must be reported to the manufacturer (MELAG) and the competent authority of the member state in which the user and/or the patient resides.

3 Performance specifications

Intended use

The steam sterilizer Vacuclave 105 is mainly intended for use in the medical field. The steam sterilizer is a small steam sterilizer according to ▶EN 13060. It uses the fractionated vacuum process to ensure effective steam penetration of the load with saturated steam. The device is suitable for sterilizing instruments and materials that may come into contact with blood or body fluids during treatment. The steam sterilizer is not intended for use on patients or in patient environment or for the sterilization of liquids. Typical user groups are doctors, trained personnel and service technicians.

▲ WARNING**Warning of material damage and injury**

Any attempt to sterilize fluids can result in a ▶delay in boiling. This can cause damage to the device and/or scalding.

- Never use this device to sterilize fluids. It is not licensed for the sterilization of fluids.

Sterilization procedure

The steam sterilizer sterilizes on the basis of the fractionated vacuum procedure. This guarantees the complete and effective wetting/penetration of the sterilization material with saturated steam.

The steam sterilizer uses integrated steam generation to generate sterilizing steam. Steam is generated in the sterilization chamber upon program start. This establishes a pre-defined pressure and a set temperature. The sterilization chamber is protected against overheating. You can sterilize instruments or textiles one after the other in a very short time, achieving excellent drying results.

Automatic preheater

If the preheater is activated, the cold sterilization chamber is heated up to the preheating temperature of the particular program before program start, or this temperature is held between two program runs. This reduces program times and reduces the accretion of condensation. This results in improved drying results.

Type of the feed water supply

The steam sterilizer works with a one-way ▶feed water system. This means that it uses fresh feed water (▶demineralised or ▶distilled water) for every sterilization procedure. The quality of the feed water is monitored via an integrated ▶conductivity measurement system. If combined with a proper preparation of the instruments, this serves largely to prevent stain accretion on the instruments and soiling of the steam sterilizer.

Program runs

A sterilization program runs in three main phases: the air removal and heating up phase, the sterilization phase and the drying phase. After program start, you can follow the program run on the display. It shows the chamber temperature and pressure as well as the time until the end of drying.

Program phases of a standard sterilization program

Program phase	Description
1. Air removal and heating up phase	Air removal In the evacuation phase, the mixture of air and steam is repeatedly evacuated and steam is generated in the sterilization chamber. This efficiently removes air from the sterilization chamber and prepares the load for sterilization. This procedure is also called the fractionated vacuum procedure.
	Heating Continued steam generation in the sterilization chamber causes an increase in pressure and temperature until the program-specific sterilization parameters are reached.
2. Sterilization phase	Sterilizing If the pressure and temperature correspond to the program-dependent nominal values, the sterilization phase begins. The corresponding process parameters (pressure and temperature) are held at sterilization level.
3. Drying phase	Pressure release The sterilization phase is followed by pressure release from the sterilization chamber.
	Drying The sterile material is dried using a vacuum (vacuum drying).
	Ventilation Upon program end, the sterilization chamber is filled with sterile air via the sterile filter and adjusted to the ambient pressure.

Program phases of the vacuum test

Program phase	Description
1. Evacuation phase	The sterilization chamber is evacuated until the pressure for the vacuum test has been reached.
2. Equilibration time	An equilibration time of 5 min will follow.
3. Measurement time	The measuring time is 10 min. The pressure increase within the sterilization chamber is measured during the measurement time. The evacuation pressure and the equilibration time or measurement time are shown on the display.
4. Ventilation	The sterilization chamber is ventilated after the end of the measuring time.
5. Test end	The display shows the test result and the leakage rate.

Safety equipment

Internal process monitoring

An independent [process evaluation system](#) (safety controller) is integrated in the electronics of the steam sterilizer. It compares the process parameters (such as temperature, time and pressure) during a program run. It monitors the parameters in terms of their threshold values during control and regulation and guarantees a safe and successful program run. A monitoring system checks the device components of the steam sterilizer for their functionality and their plausible interaction. If one or more parameters exceeds pre-determined threshold values, the steam sterilizer issues warning or malfunction messages and if necessary, aborts the program. In the case of a program abort, follow the instructions on the display.

The steam sterilizer uses an electronic parameter control. This enables the steam sterilizer to optimise the total operating time of a program depending on the load.

Door mechanism

The device constantly checks pressure and temperature in the sterilization chamber and prevents the door from being opened during the program run and when over-pressure has built up.

Feed water quality

The quality of the [feed water](#) is checked automatically during each program run.

Performance characteristics of sterilization programs

The results in this table show which inspections were performed on the device. The marked fields demonstrate compliance with all the applicable sections of the standard ▶EN 13060.

Type tests	Universal B	Quick S	Gentle B	Prion B
Program type in accordance with EN 13060	Type B	Type S	Type B	Type B
▶Dynamic pressure test of the sterilization chamber	X	X	X	X
▶Air leakage	X	X	X	X
▶Empty chamber test	X	X	X	X
▶Solid load	X	X	X	X
▶Porous partial load	X	--	X	X
▶Porous full load	X	--	X	X
▶Simple hollow bodies	X	X	X	X
▶Product with narrow lumen	X	--	X	X
▶Single wrapping	X	--	X	X
▶Multiple wrapping	X	--	X	X
Drying ▶solid load	X	X	X	X
Drying porous load	X	--	X	X
Sterilization temperature	134 °C	134 °C	121 °C	134 °C
Sterilization temperature band	134-137 °C	134-137 °C	121-124 °C	134-137 °C
Sterilization pressure	2.1 bar	2.1 bar	1.2 bar	2.1 bar
Plateau period	5:30 min	3:30 min	20:30 min	20:30 min
X = complies with all applicable sections of the standard EN 13060				

4 Description of the device

Scope of delivery

Please check the scope of delivery before setting up and connecting the device.

- Vacuclave 105
- User manual
- Manufacturer's inspection report and declaration of conformity
- Warranty certificate
- Record of installation
- MELAG USB stick
- Feed water hose (black, incl. suction filter and plug for feed water container)
- Outlet hose (red)
- Wastewater container (5 l) incl. screw cap
- Power cable
- Tray lifter
- Tool for emergency manual door opening

PLEASE NOTE

At manual feed water supply in addition, a separate feed water container with a capacity of at least 2 l is required (not included in the scope of delivery).

- To optimise work processes, MELAG recommends using a feed water container of the same size as the wastewater container.

For other components that can be used with the device, see [Components, accessories and spare parts](#) [▶ page 83].

Views of the device

Front



- 1 Touch display
- 2 Door (swings open to the left)
- 3 Door handle

Rear panel

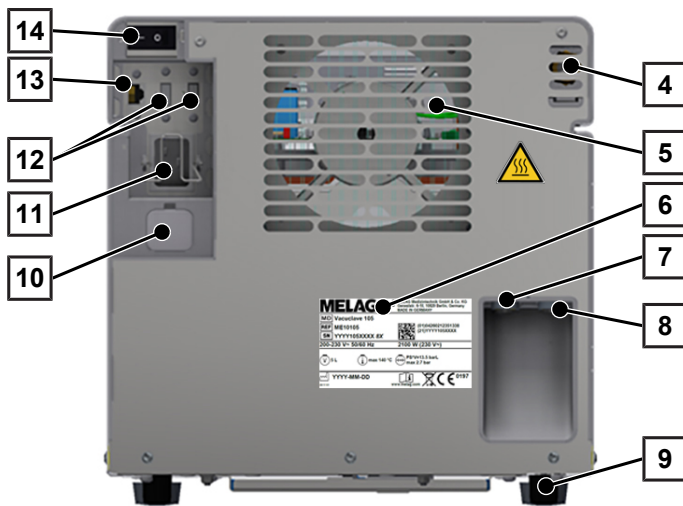

- 4 Spring loaded safety valve
- 5 Cooler
- 6 Type plate
- 7 Wastewater connection
- 8 Feed water connection
- 9 Device foot
- 10 Emergency door opening (behind closure plug)
- 11 Connection for power cable with locking clip
- 12 USB connections
- 13 Ethernet connection
- 14 Power switch

View of the interior

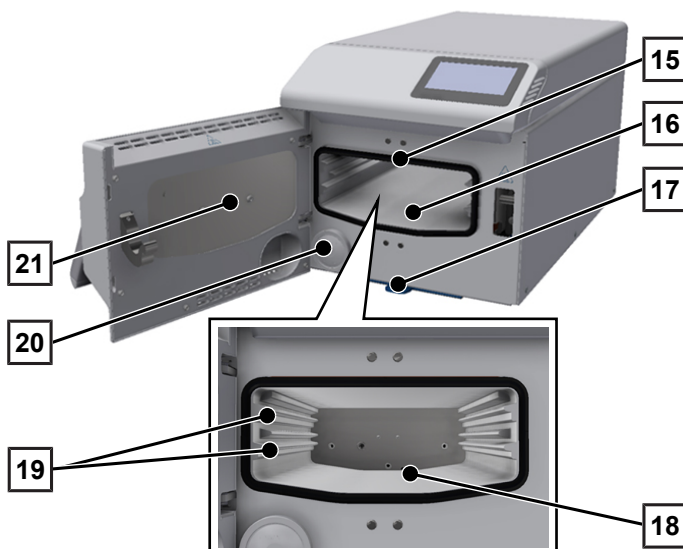

- 15 Door gasket
- 16 Sterilization chamber
- 17 Dust filter
- 18 Pressure release/vacuum fitting
- 19 Tray rails
- 20 Sterile filter
- 21 Inner door surface

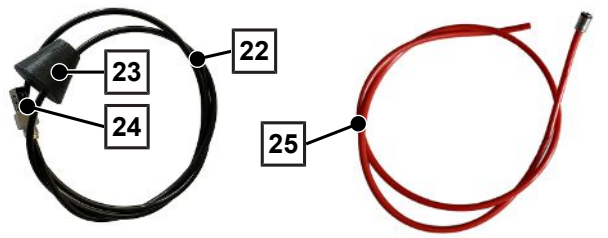

- 22 Feed water hose
- 23 Plug for feed water container
- 24 Suction filter
- 25 Outlet hose



- 26 Wastewater container incl. screw cap
- 27 Tray lifter
- 28 Tool for emergency manual door opening

Symbols on the device

Type plate



Manufacturer of the product



Date of manufacture of the product



Label as medical device



Article number of the product



Serial number of the product

- Two, alphanumeric check characters for software reinstallation, separated by spaces, written in italics. The check characters are not part of the serial number or the UDI.



Observe user manual or electronic user manual



Do not dispose of product in household waste



CE marking



Identification number of the notified body responsible for conformity assessment according to Regulation (EU) 2017/745 on medical devices



Volume of the sterilization chamber



Working overpressure in sterilization chamber



Operating temperature in sterilization chamber



Electrical connection of the product: Alternating current (AC)

Warning symbols



The marked area becomes hot during operation. Contact with it during or shortly after operation can pose the danger of burns.

Symbols on the power switch



Switching on device



Switching off device

Symbols on the water connections



Feed water connection

Inlet



Wastewater connection

Outlet

Touch display

The user interface consists of a colour 4.3-inch touch display. USB connections for data export (e.g. log output) and data import (e.g. software update) are located on the rear of the device.



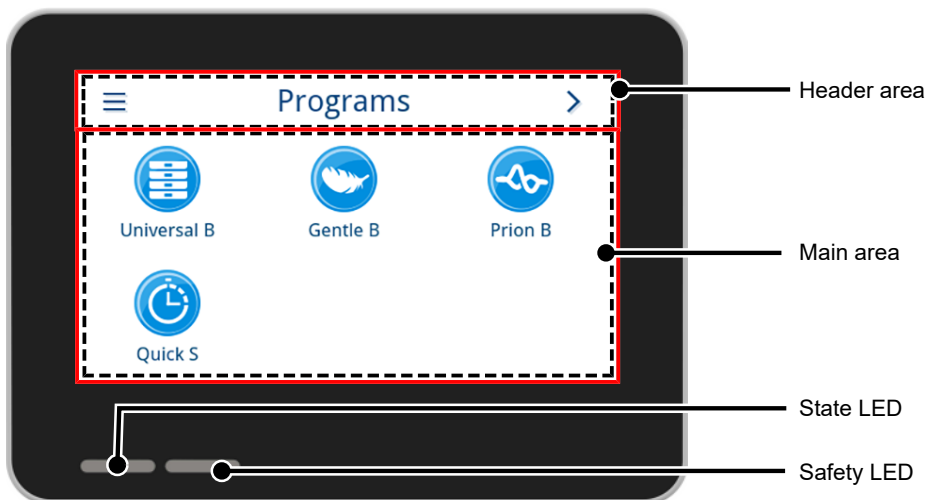











The representation in the areas is dynamic and changes depending on the status of the device.















Header area

The header area provides information about the currently opened menu and the status of the device.

The buttons or status icons are shown or hidden depending on the menu or the status of the device.

Button	Name	Description
	MENU	Open main menu
	EXIT	Exit current menu level
	OPEN	Open log for reading
	CONTINUE	Navigate forward within the menu level
	RETURN	Navigate backwards within the menu level
	DOWN	Navigate downwards within the display
	UP	Navigate upwards within the display
	DETAIL	Display of critical process parameters after the end of the program
	OUTPUT	Open output settings for output status
	EDIT	Edit within the Settings menu level
	ENERGY SAVING	Energy-saving mode active End energy-saving mode
	DEVICE STATUS	Open device data (e.g. serial number, real-time conductivity meter)
	WARNING	Warning message present Maximise warning view
	MALFUNCTION	Malfunction message present Maximise malfunction message view









Symbol	Description
	User role administrator
	User role service technician
	User role practice employee
	Computer connected

Symbol	Description
	MELAt race connected
	Printer connected
	USB flash drive connected
	Door locked
	Door is locked during a running program
	Program successful
	Program not successful
	Malfunction log

Main area













In the main area, the device is controlled via buttons for program selection and for activating/deactivating functions. The program status is displayed while a program is running.

Messages and/or user instructions are displayed depending on the status of the device.

Button	Name	Description
	OPTIONS	Open the program options of the displayed program
	EDIT	Switch to the settings level
	SELECT	Change or select parameters
	SELECT	Change or select parameters
	ACTIVATE	Select several parameters, functions or output media <ul style="list-style-type: none"> • Blue background = selection/activation • Grey background = no selection/activation
	ENTER	Confirm entry
	KEYBOARD	Select country-specific keyboard
	ACTIVATE	Select parameter or function <ul style="list-style-type: none"> • Blue tick = selection/activation • Grey tick = no selection/activation
	OFF/ON	Activate (ON) or deactivate (OFF) functions <ul style="list-style-type: none"> • Blue background = active selection

LED display and acoustic signals

Two independent safety systems continuously monitor the sterilization process during each program run. An acoustic signal is linked to the colour of the LED display and indicates an expected event.

State LED		Safety LED		Description	Safety instructions
	Blue	--		• Device started	--
	Blue	--		• Door unlocked/opened • Door open for more than 120 s	
	Green	--		• Program completed successfully	
	Yellow	--		• Warning	
   	Blue Green Yellow Red		Red	• Malfunction • Program not completed successfully	WARNING! If the safety LED lights up red, there is a malfunction and the program was not completed successfully. The load was not sterilized!
	Red		Red	• Abort program run (before start of Drying program phase)	
	Blue	--		• Energy-saving mode • Software update is running • Device in operation • No program active • Program in progress	--

5 Installation requirements

▲ WARNING

Failure to comply with the setup conditions can result in injuries and/or damage to the device.

- The device is not suitable for operation in explosive atmospheres.
- The device is intended for use outside the patient treatment area. The device should be located a minimum of 1.5 m radius away from the treatment area.
- Install and operate the device in a frost-free environment.

Installation location

Steam egress can occur during operation. Do not set up the device in the immediate proximity of a smoke detector. Maintain clearance from materials which could suffer damage from steam.

Make sure that the ambient conditions meet the requirements, see [Technical data](#) [▶ page 82].

Electromagnetic environments

When assessing the electromagnetic compatibility (EMC) of this device, the emission limits for Class B devices and the immunity for operation in a basic electromagnetic environment are based on [IEC 61326-1](#). The device is thus suitable for operation in all facilities including those in residential areas and those that are directly connected to a public mains supply that also supplies buildings used for residential purposes. The floor should be made of wood or concrete or be tiled with ceramic tiling. If the floor is fitted with synthetic material, the relative humidity must be at least 30 %. Humidity reduces the development of electrostatic discharges.

Space requirements

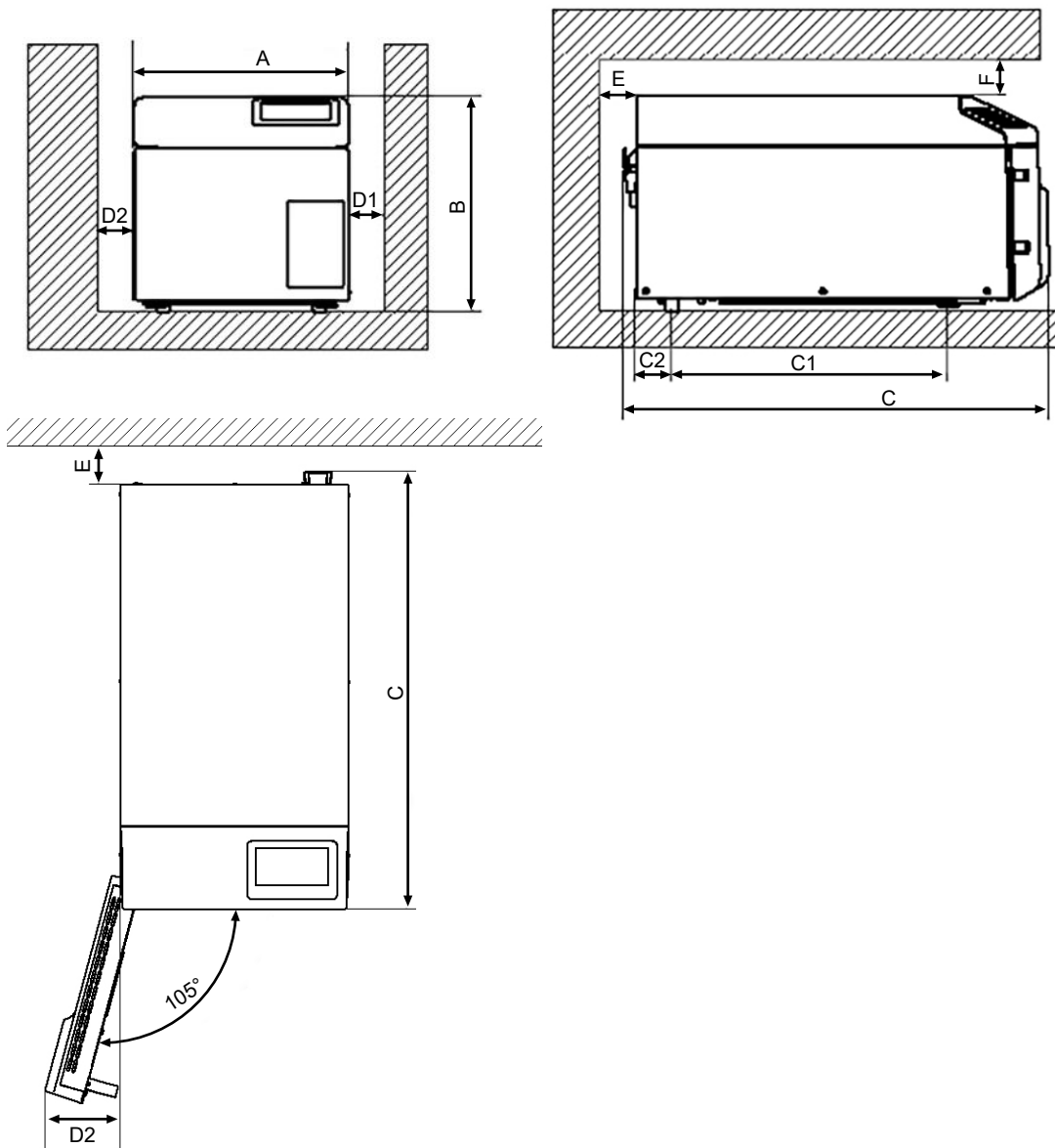

Dimensions		Vacuclave 105
Width	A	30 cm
Height	B	30 cm
Depth, total	C	59 cm
Clearance between the device feet	C ₁	25 cm
Clearance from rear device foot up to the rear panel	C ₂	18.5 cm
Min. clearance to the side	D ₁	5 cm
Min. clearance to the side of the door hinge	D ₂	10 cm
Min. clearance to the rear	E	5 cm
Min. clearance to the top (can be pulled out / with exhaust shaft)	F	10 cm

The steam sterilizer works with a cooler on the rear of the device. The function and life-span of the steam sterilizer can be compromised if heat dissipation via the cooler is restricted in any way. The steam sterilizer may only be installed if sufficient air circulation can be guaranteed.

Additional space requirements

In addition to the space required for the steam sterilizer, you need space for the feed water and wastewater containers. Place the feed water and wastewater containers max. 1.5 m below the device.

Requirements for incorporating the device

If the incorporation of the device is absolutely necessary, ensure that the device can be removed for maintenance and operation (pos. a). In addition, implement one of the following measures:

- In the installation space, there must be an exhaust shaft in the rear area that discharges the warm air upwards (pos. b).
- There must be an exhaust shaft in the rear area of the installation space that actively discharges the warm air to the rear (pos. c).

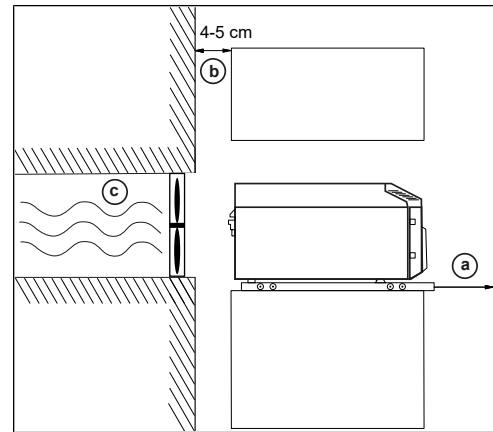

Mains connection

Make sure that the electrical connection meets the requirements on site, see [Technical data](#) [▶ page 82].

System and network safety

The device is fitted with multiple external interfaces. Comply with the following information pertaining to the use of these interfaces to ensure safe operation of the device, especially to ensure incorporation in the local network (LAN).

Interfaces and connections

Comply with the following for safe handling:

- Only connect the hardware to the device which is listed in the following table.
- Only use the software which has been intended for the purpose and approved by the manufacturer.
- When performing a device software update, use only the update data authorised by MELAG for the corresponding device type.

Interface	Type	Hardware	Software/purpose
USB 1	Type A configured as <i>Host</i>	MELAG USB flash drive with FAT32 file system	Saving log data
		MELAG USB flash drive with FAT32 file system and software update container	Device software update
USB 1	Type A configured as <i>Device</i> ¹⁾	USB type-A socket	MELAview Service saving log data, querying device data
			MELAtrace saving log data
USB 2	Corresponds to the host configuration of the USB 1 interface		
		MELAprint 80	Log printing

¹⁾ Activate in the menu Service > MELAview

Interface	Type	Hardware	Software/purpose
Ethernet	Ethernet IEEE 802.3	Switch port (Practical network)	MELAvue Service saving log data, querying device data
			MELAtace saving log data
			FTP server save log data
		Connection to the practice's network	
		MELAprint 80	Log printing

Operating the device with memory media

To prevent data loss, only use memory media to save the log data with the following characteristics:

- functional (without malware, etc.)
- writeable
- formatted with a correct file system (FAT32)

Perform regular data backup. Restrict access to the device and systems with access authorisation to the necessary circle of persons.

Only use MELAG USB sticks.

Operating the device in the local network (LAN)

An Ethernet/IP-based network connection (LAN) is required to operate the device in a local network. In its delivery state, the device is configured to obtain the IP address automatically from a DHCP server operated in a LAN.

Comply with the following for safe handling:

- To avoid security vulnerabilities, do not connect the device to a public network (e.g. the internet).
- Check the IP address carefully during the conversion for a manual configuration before connecting the device to the LAN. An incorrectly-entered IP address can cause IP conflicts in the network and thus disturb another device in your network.

In the LAN with a firewall, only permit connections to and from the device which correspond to the intended use of the device. All ports not used are blocked on the device side.

The device is able to make the following connections as standard:

Log	Source port	Destination port	Direction	Purpose
TCP	63000 - 64000	21	Outgoing	FTP control
TCP	any	63000 - 64000	Listening/ Incoming	FTP (passive) data transfer (device set to FTP logging)
UDP	68	67	Outgoing	Communication to DHCP server - requests to the DHCP server
UDP	67	68	Listening/ Incoming	Answers from DHCP server(s)
TCP	any	3333	Listening/ Incoming	Data transfer log data (device set to TCP logging)
UDP	62000	3000	Outgoing	Broadcast search printer
UDP	3000	62000	Listening/ Incoming	Search answers printer
TCP	≥ 1025	9100	Outgoing	Data transfer to the printer

Network bandwidth/Quality of Service (QoS)

The device does not place any requirements on the LAN bandwidth for data transfer, that exceed the standard time-out times of the respective logs.

Process	Volume max.	Volume normal
Program log	1 MB	200 kB
Malfunction log	64 kB	10 kB
Status log	64 kB	20 kB
System log	5 MB	--

6 Setup and installation

Comply with the following for safe handling:

- For the initial commissioning, observe all instructions described in the user manual.
- The spring safety valve must be able to move freely and not become stuck or blocked. Position the device in such a way that the faultless functioning of the spring safety valve is guaranteed.

Removing from the packaging

PLEASE NOTE

Check the external condition of the packaging before opening. Do not use the device if the packaging is damaged, has already been opened, or has been exposed to environmental conditions outside the specified storage or transport conditions. In this case, inform the authorised dealer or the responsible carrier and retain the transport packaging.

MELAG recommends wearing protective gloves when removing the device from the packaging:

1. Carefully open the transport packaging from above.
2. Remove the device from the transport packaging.
3. Check the device for any damage suffered during transport.

Setting the water supply and disposal

Steam sterilization requires the use of ▶distilled or ▶demineralised water water, known as ▶feed water. The ▶EN 13060 specifies the guideline values to be observed.

Manual water supply and disposal

Comply with the following for safe handling:

- Only operate the device with the feed water and wastewater container connected.
- Danger of scalding from hot water. Ensure that the wastewater container is connected correctly.

The feed water is supplied via an external feed water container. A minimum quantity of approx. 0.5 l of feed water is required for successful sterilization. The wastewater is drained into the wastewater container via the outlet hose.

Feed water supply

The following must be fulfilled or present:

- ✓ A feed water container with a capacity of at least 2 l (not included in the scope of delivery) is provided.
1. Place the full feed water container (pos. c) so that it is freely accessible underneath the device.
 2. Guide the feed water hose (pos. a, black) into the feed water container until the suction filter (pos. d) rests on the floor.
 3. Close the feed water container by turning the plug (pos. b) slightly and inserting it firmly. Ensure that the stopper and container neck are dry. The plug must not slip out.
 4. Connect the feed water hose to the "Inlet" feed water connection on the rear of the device as far as it will go.

PLEASE NOTE: Install the hose free of kinks and sagging and as short as possible. Shorten the hose if necessary.

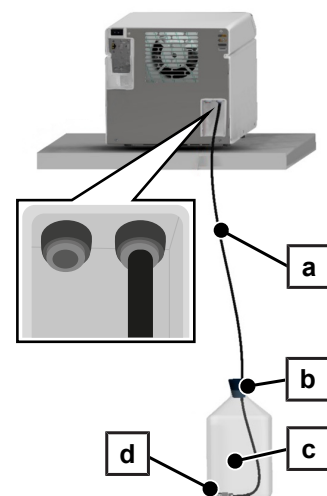

Wastewater disposal

1. Place the empty wastewater container (pos. g) so that it is freely accessible underneath the device.
2. Insert the outlet hose (pos. e, red) into the connector (quick coupling) on top of the screw cap (pos. f) as far as it will go.
3. Screw the screw cap onto the wastewater container. The hose does not need to be held in place as it can be swivelled in the plug connection.
4. Connect the outlet hose to the "Outlet" wastewater connection on the rear of the device as far as it will go.

PLEASE NOTE: Install the hose free of kinks and sagging and as short as possible. Shorten the hose if necessary.

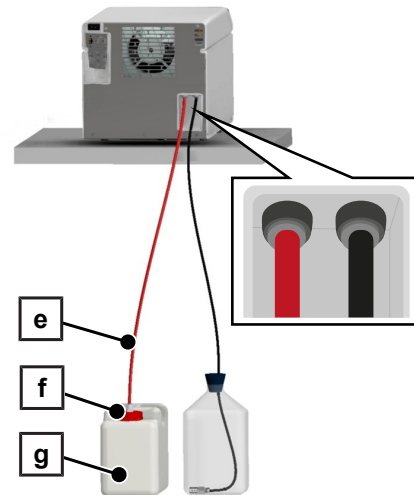

PLEASE NOTE: To detach the hoses from the device, see [Replacing hoses](#) [▶ page 74].

Automatic water supply and disposal

Example: Installation with MELAdem 40 ion exchanger

The MELAdem 40 can be attached to the wall or in the base cabinet with the help of the mount for the wall fixing. Always install an automatic water disposal for an automatic water supply. Use the water connection set for this. In addition, it is necessary to install a water stop.

1. Connect the outlet hose to the existing double chamber U-trap of the building's wastewater system.
2. Connect the other end of the outlet hose to the "Outlet" wastewater connection on the rear of the device as far as it will go.

PLEASE NOTE: Install the outlet hose free of kinks and sags. The outlet hose must not be longer than 2.5 m. Shorten the hose if necessary.

3. Fasten the safety combination HD to the wall. When doing so, pay attention to the flow direction indicated on the safety combination. Observe the minimum distance of the fall section (25 cm) above the following maximum liquid level. Use additionally a water tap with safety combination.

PLEASE NOTE: Comply with all relevant national specifications of the drinking water protection.

4. Install the flow regulator between the MELAdem 40 and the steam sterilizer. Ensure the correct flow direction.
5. Connect the feed water hose to the "Inlet" feed water connection on the rear of the device as far as it will go.

PLEASE NOTE: Install the hose free of kinks and sagging and as short as possible. Shorten the hose if necessary.

NOTICE

Warning of material damage from improper installation

There is a risk of water damage if the water connection is installed improperly.

- Check all water connections and joints.

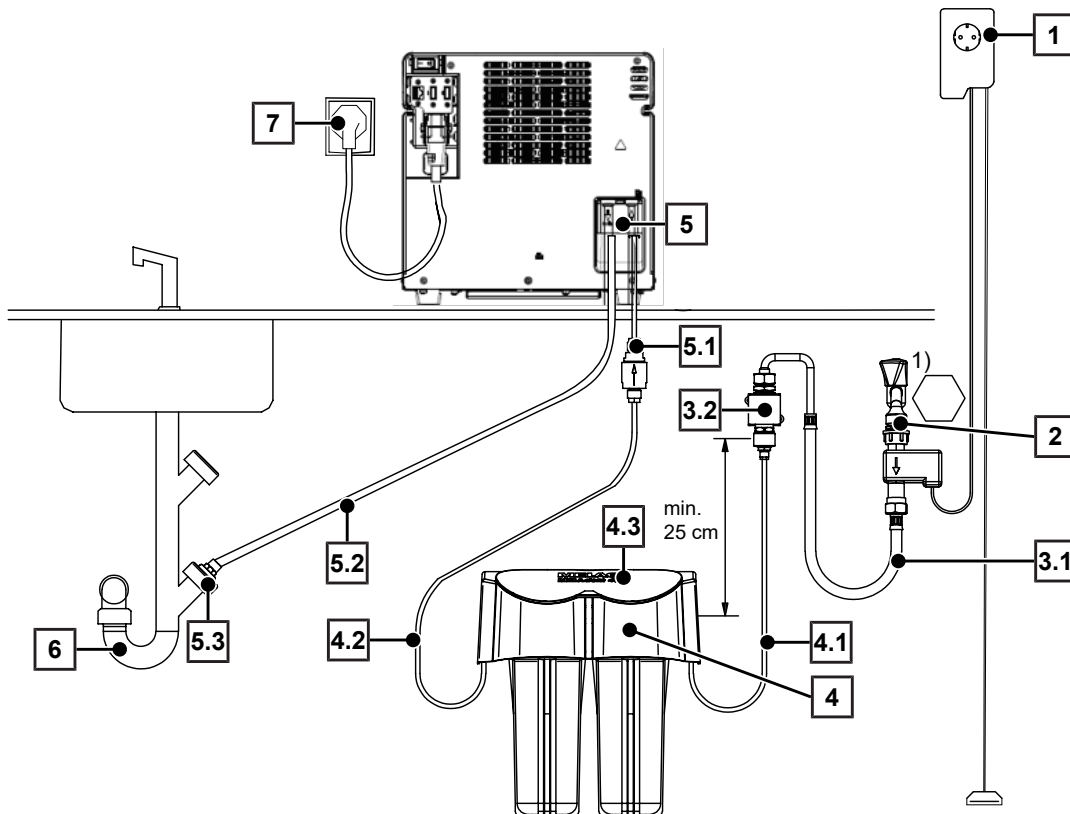

1) Comply with all relevant national specifications of the drinking water protection.

Pos.	Description	Art. no.	Note
1	Water stop (leakage water detector with shut-off valve and probe)	ME01056	optionally available to order
2	Water tap 3/4" with safety combination	ME37310	on-site
3.1	Water inlet hose EN 1717 (2.5 m)	ME24930	contained in ME70686
3.2	Safety combination HD with wall mount incl. hose (2.5 m)	ME70686	optionally available to order
4	MELAdem 40 ion exchanger	ME01049	optionally available to order
4.1	PUR hose (black) 6/4 mm (10 m)	ME28820	contained in ME01049
4.2	PUR hose (black) 6/4 mm (10 m)	ME28820	contained in ME01049
4.3	Holder for wall mounting (2 pcs.)	ME15856	optionally available to order
5	Water connection set	ME09046	optionally available to order
5.1	Feed water filter with flow regulator	--	contained in ME09046
5.2	Outlet hose for steam sterilizer, 2.5 m	ME86523	optionally available to order
5.3	Wastewater connection for U-trap	ME09045	contained in ME09046
6	Double-chamber siphon	ME26635	optionally available to order
7	Mains connection	--	on-site

Connecting the mains cable

Comply with the following for safe handling:

- Only the power cable included in the scope of delivery may be connected to the device.
- The power cable may only be replaced by an original spare part from MELAG.
- Comply with all legal requirements and locally-specified connection conditions.
- Never operate the device if the plug or power cable are damaged.
- Never damage or alter the power plug or cable.
- Never bend and twist the power cable.

- Never unplug by pulling on the power cable. Always take a grip on the plug.
- Ensure that the power cable does not become jammed in.
- Never place any heavy objects on the power cable.
- Never lead the cable along a source of heat.
- Never fix the power cable with sharp objects.
- The mains socket must be freely accessible after installation so that the device can be disconnected from the electrical mains at any time if necessary by pulling the mains plug.

NOTICE

Warning of material damage

Operating the device outside the specified ambient temperature (5-40 °C) can lead to damage to individual device components (e.g. circuit boards, vacuum pump, etc.).

- Allow the device to acclimatise to the required ambient temperature (5-40 °C) before switching it on for the first time.

1. Connect the power cable (pos. b) at the rear of the steam sterilizer and fold down the retaining bracket (pos. a).

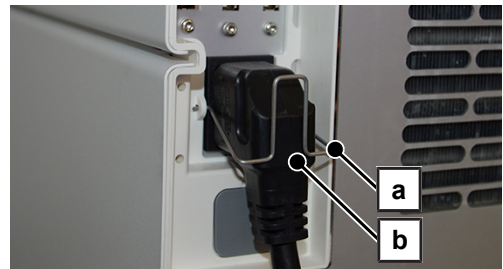

2. Plug the power plug of the device into the power socket of the practice.

Aligning the device

For fault-free operation, tilt the device slightly (2°) backwards so that the residual water/condensate can drain out of the sterilization chamber.

1. Use a spirit level to align the device horizontally.

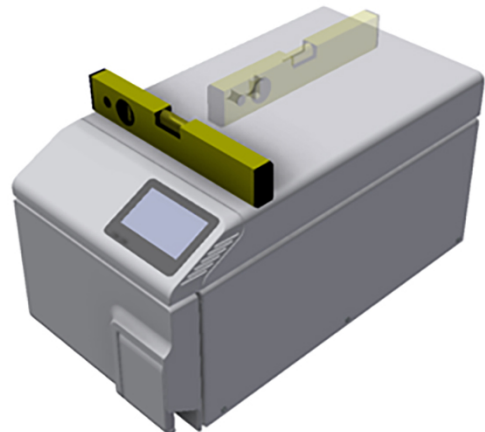

2. Unscrew the front device feet by five turns.

Switching on the device

The following must be fulfilled or present:

- ✓ The device is connected to the power supply.
- ✓ The feed water container is connected and filled with fresh feed water of appropriate quality.
- ✓ The wastewater container is connected and empty on initial commissioning.

1. Switch the device on at the power switch (see circular marking).

PLEASE NOTE: The safety LED lights up briefly while the device is starting. This is a self-test.



2. Observe the note on the level of the water containers and confirm the note with **OK**.

PLEASE NOTE: The note to check the containers appears every time the device is started and after 15 cycles.

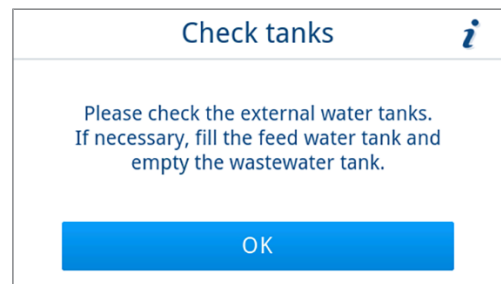

→ The start screen and then the **Programs** menu appear on the display.

3. **PLEASE NOTE:** You can start a program immediately without waiting for the preheating time.

Within the first 60 s after the device is started, press **>** to switch to the **Service programs** [▶ page 47] menu, to prevent automatic preheating.



Opening and closing the door

The device has an automatic locking mechanism that ensures that the door cannot be opened until it has been unlocked automatically (after starting the device) or by the user (after the program run).

The door is locked when:

- The device is switched off
- The device is in a currentless condition
- The device is in energy-saving mode
- A program is running

Opening the door

After switching on the device

The following must be fulfilled or present:

- ✓ The device is switched on and booted up.
- ✓ An audible click is heard.
- ▶ Pull the door handle gently; do not use force.

PLEASE NOTE: The door is to be left open only whilst loading and unloading the device. Keeping the door closed saves energy.



After a program run

The following must be fulfilled or present:

- ✓ The program is ended.
 - ✓ The **Unlock door** button has been pressed.
1. An audible click is heard and the adjacent note is displayed.



2. Pull the door handle carefully and not forcibly.

Close the door

- ▶ **NOTICE! Warning of damage to the door lock. Do not slam the door shut.**

Press the door lightly against the device and fold in the door handle.



➡ After the door has been closed, the display changes to the **Programs** menu.

Checking the software version

1. Check the software version, see [Checking the software version](#) [▶ page 69].
2. Update the software if necessary, see [Software update](#) [▶ page 69].

Checking date and time

Date and time of the device must be correctly set for proper batch documentation. Ensure that you take into account any clock change, as this is not adjusted automatically.

1. Check the date and time in the header of the display in the main menu.
2. If necessary, set the date and time in the **Settings** menu, see [Date](#) [▶ page 51] and [Time](#) [▶ page 52].

Setting the display and audio

If necessary, adjust the brightness in the **Settings** menu and activate/deactivate the signal tone, see [Display](#) [▶ page 53] and [Audio](#) [▶ page 54].

Test runs

Carry out the following test runs after the installation and record the results in the installation log.

PLEASE NOTE: When starting a program for the first time and after changing the feed water container, there may be a brief increase in noise. This ends as soon as feed water reaches the device again.

Vacuum test with cold sterilization chamber

Perform a **Vacuum test chamber** with an empty cold sterilization chamber and record the result.

Program Universal-B

If the vacuum test was successful, run the **Universal B** program with 0.8 kg load (instruments). Include a helix test (e.g. MELAcontrol Helix) with the program, if available. Log the result.

Check for leaks

After the **Universal B** program, check the installed hose connections for tightness.

Instructing the users

Explain all user-typical properties for the documentation and setting options for the user in accordance with the record of installation.

The documents included in the scope of delivery (e.g. manufacturer's inspection report) must be kept by the operator. The declaration of conformity of the Medical Device Regulation are included in the manufacturer's inspection report.

Resetting the maintenance counter

The maintenance counter runs even in a device not yet in operation.

- ▶ Only for installation by a service technician: Reset the maintenance counter and log out of the user role **Service technician**.

Record of installation

The record of installation is to be completed and a copy sent to MELAG as proof of the correct setup, installation and initial commissioning. This is a constituent part of any guarantee claim.

7 Important information for routine operation

Comply with the recommendations issued by the Robert Koch Institute (▶[RKI](#)) and the information contained in ▶[DIN 58946-7](#).

Manufacturer’s recommendation for the routine operation of type B steam sterilizers²⁾

When is it necessary to make checks?	How should the checks be made?
Daily	<ul style="list-style-type: none"> • Visual check of the door gasket and the door lock for damage • Check the operating media (electricity, ▶feed water and water connection if necessary) • Check the documentation media (printer paper, computer, network) <p>MELAG recommends conducting the steam penetration test with MELAcontrol Helix/SteriHero Helix in the Universal-program.</p>
Weekly	<ul style="list-style-type: none"> • Vacuum test chamber <p>Tip: Before starting work in the morning – the device must be cold and dry</p>
Batch-related tests	<p>With “Critical B” instruments:</p> <ul style="list-style-type: none"> • MELAcontrol Helix/SteriHero Helix are to be included as ▶batch controls with every sterilization cycle. <p>With “Critical A” instruments:</p> <ul style="list-style-type: none"> • The process indicator (type 5 in accordance with ▶EN ISO 11140) must be used as batch control with every sterilization cycle. <p>With “Critical A + B” instruments:</p> <ul style="list-style-type: none"> • The MELAcontrol Helix/SteriHero Helix are to be included as a batch control during every sterilization cycle. <p>This simplifies the working procedure and increases security. The daily steam penetration test with the MELAcontrol Helix/SteriHero Helix (see above) can then be omitted. The use of another test system is possible. The number of the available test systems means that MELAG is not able to provide technical support when using a different system.</p> <p>MELAstore Box Compact: Place MELAstore Box Compact backwards on a flat tray. Position a suitable Helix test in front of the sterile container.</p>

PLEASE NOTE Document the results of the tests. The test strips used need not be stored.

Feed water and wastewater containers

Comply with the following for safe handling:

- Danger of burns! The wastewater and the wastewater container may be hot. Allow the wastewater container to cool down before changing or emptying it.
- Never change or empty the wastewater container during a program run.
- Replace damaged containers.

A message to check the container appears on the display every time the device is started and after every 15 cycles:

1. Check the level of the feed water container before the program start. If necessary, top up the feed water container or replace it, see [Manual water supply and disposal](#) ▶ page 22].

²⁾ in accordance with the current recommendations from the Robert Koch Institute

2. Empty the wastewater container immediately after filling or changing the feed water to prevent it from overflowing.

PLEASE NOTE: When the screw cap of the wastewater container is screwed on or off, the outlet hose remains on the screw cap. The hose does not need to be held in place as it can be swivelled in the plug connection.

3. Confirm the subsequent dialog window with **OK**.

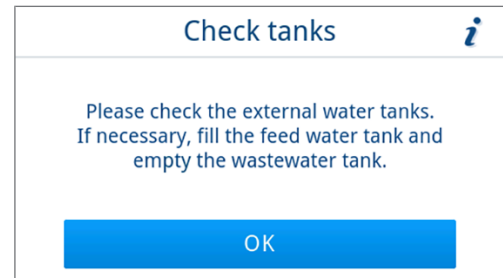

8 Sterilization

Preparing the load

Always clean and disinfect properly before sterilization. Only in this way is it possible to guarantee the subsequent sterilization of the [▶load](#). The materials used, cleaning agents and reprocessing procedure are of decisive significance.

Comply with the following for safe handling:

- Only ever use packaging material and systems which have been cleared by their manufacturer for steam sterilization.
- Only use original MELAG articles or third-party articles approved by MELAG. No warranty can be provided for non-approved third-party articles, even if validation has been successfully carried out.

Reprocessing instruments

Unwrapped sterile material loses its sterility on contact with ambient air. If you intend to store your instruments sterilely, wrap them in suitable packaging before sterilization.

When [▶reprocessing](#) used and brand-new instruments, comply with the following:

- Always observe both the instrument manufacturer's reprocessing instructions and the relevant standards, guidelines and directives (in Germany, for example, from [▶RKI](#), [▶DGSV](#) and [▶DGUV Regulation 1](#)).
- Clean the instruments exceptionally thoroughly e.g. using an ultrasonic device or washer-disinfector.
- Rinse the instruments after washing and disinfecting, where possible with demineralised or distilled water, and then dry the instruments thoroughly with a clean, non-fuzzing cloth.
- Re-dry the spray, air and water channels using medical compressed air.
- Use only those care agents suitable for steam sterilization. Consult the manufacturer of the care agents. Do not use any water repellent agents or oils impermeable to steam. MELAG recommends the use of MELAG Care Oil Spray.
- When using ultrasound devices, care equipment for handpieces and washer-disinfectors, comply with the manufacturer's reprocessing instructions.
- Remove any residual disinfection and cleaning fluids to avoid corrosion. Otherwise, this could result in increased maintenance requirements and a restriction of the device function.

Reprocessing textiles

The incorrect reprocessing of textiles, e.g. a textile package can prevent steam penetration or produce poor drying results. This may result in the textiles **not** being sterile.

Please note the following when [▶reprocessing](#) textiles:

- Comply with both the reprocessing instructions of the textile manufacturer the relevant standards, guidelines and directives (in Germany e.g. of the [▶RKI](#) and [▶DGSV](#)).
- Arrange the folds in the textiles parallel to each other.
- Do not arrange textiles too close together so that flow channels can form.
- If textile packages do not remain together, wrap the textiles in sterilization paper.
- Only ever sterilize dry textiles.
- The textiles may not be permitted to come into direct contact with the sterilization chamber; otherwise they will become saturated with [▶condensate](#).

Loading the steam sterilizer

Effective sterilization and good drying is only possible if the steam sterilizer has been loaded correctly.

Ensure the following during loading:

- Always use trays from MELAG for sterilization of the load, see [Components, accessories and spare parts](#) [▶ page 83].
- Slide trays between the tray rails.

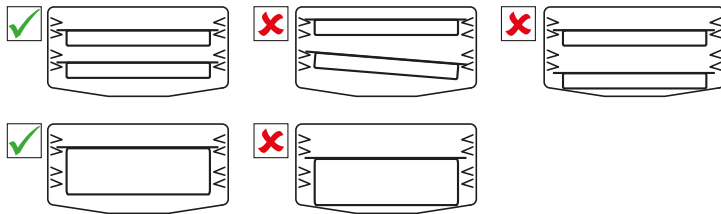

- Wherever possible, ensure the separate sterilization of textiles and instruments in separate sterilization packages. This leads to better drying results.
- The use of paper tray inserts can result in poor drying results.
- Use perforated trays from MELAG. Only in this way can ▶condensate drain off. Non-perforated bases or half-shells for holding the ▶load lead to poor drying results.

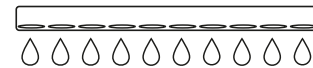

Packaging

Only ever use packaging materials and systems (▶sterile barrier systems) which fulfil the standard ▶EN ISO 11607-1. The correct use of suitable packaging is important in achieving successful sterilization results. You can use re-usable rigid packaging systems or soft packaging such as transparent sterilization package, paper pouches, sterilization paper, textiles or fleece.

Closed sterile containers

Please comply with the following when using closed sterile containers:

- Use only MELAstore Box Compact on a flat tray, see [Components, accessories and spare parts](#) [▶ page 83].

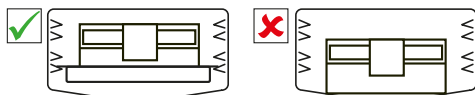

PLEASE NOTE: MELAG sterilization containers meet all the requirements of ▶EN 868-8 for successful sterilization and drying. MELAstore Box Compact are perforated in the lid and may be used with disposable paper filters and permanent filters.

Soft sterilization packaging

▶Soft sterilization packages can be sterilized on trays. Please comply with the following when using soft sterilization packages e.g. MELAfol:

- Arrange transparent sterilization packages with the paper side facing down and a short distance apart.
- Do not place multiple soft sterilization packages flat on top of each other on a tray.
- If the seal seam tears during sterilization, this could be caused by the choice of undersized packaging. Pack the instruments with larger packaging and perform sterilization again.
- Should the seal seam tear during sterilization despite sufficient bag size, adjust the sealing temperature on the sealing device or make a double seam.

Multiple wrapping

The device uses a fractionated vacuum procedure. This permits the use of ▶multiple wrapping, see [Selecting the program](#) [▶ page 33].

Mixed loads

Please observe the following when sterilizing ▶mixed loads:

- Always place textiles at the top
- Place unwrapped instruments at the bottom
- Place the heaviest loads at the bottom
- Transparent sterilization packages and paper packages on the top. Exception: At the bottom in combination with textiles

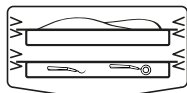

Loading volumes

Max. weight per component

Load*)	Instruments	Textiles
Max. weight per component	1 kg	0.45 kg
*) MELAG trays, see Components, accessories and spare parts [▶ page 83].		





Selecting the program

All sterilization programs are displayed in the **Programs** menu. The following tables show you which program you use for which load and which service programs are also available to you.

When selecting the sterilization program, proceed as follows:

- Select the sterilization program based on which products you want to sterilize.
- Select the sterilization program according to whether and how the load is wrapped.
- Observe the permissible max. load quantities.
- Note the temperature resistance of the load.

Overview of sterilization programs

Program	Suitable for		Max. load quantity	Operating time ^{*)}	Drying ^{**)}
 Universal-B 134 °C 2.1 bar 5:30 min	<ul style="list-style-type: none"> • Transmission instruments • Products with narrow lumen • Simple hollow bodies 	Instruments:			8 min
		• single wrapped	1.5 kg	11-16 min	
		• double wrapped	1.5 kg	11-16 min	
		• unwrapped	2 kg	11-16 min	
		Textiles:			
		• double wrapped	0.45 kg	11-15 min	
		Sterile container	2 kg	11-23 min	
 Quick-S 134 °C 2.1 bar 3:30 min	<ul style="list-style-type: none"> • Simple solid instruments • Simple hollow bodies 	Instruments:			5 min
		• unwrapped	1 kg	6:30-10 min	
		No textiles and sterile containers			
 Gentle-B 121 °C 1.2 bar 20:30 min	<ul style="list-style-type: none"> • Thermo-unstable equipment (e.g. plastic, rubber, textiles) • Products with narrow lumen • Simple hollow bodies 	Instruments:			20 min
		• single wrapped	1.5 kg	26-32 min	
		• double wrapped	1.5 kg	26-32 min	
		• unwrapped	2 kg	26-32 min	
		Textiles:			
		• double wrapped	0.45 kg	26-30 min	
		Sterile container	2 kg	26-40 min	
 Prion-B 134 °C 2.1 bar 20:30 min	Instruments with more stringent sterilization requirements ^{***)} : <ul style="list-style-type: none"> • Transmission instruments • Products with narrow lumen • Simple hollow bodies 	Instruments:			8 min
		• single wrapped	1.5 kg	26-32 min	
		• double wrapped	1.5 kg	26-32 min	
		• unwrapped	2 kg	26-32 min	
				Textiles:	
		• double wrapped	0.45 kg	26-30 min	
		Sterile container	2 kg	26-40 min	

*) Without drying and depending on the load and installation conditions (e.g. supply voltage). If the device is started cold, the time may be extended by a few minutes.

**) The values given correspond to the preset values ex works. The drying time can be adjusted between 1-60 min, see [Drying \(flexDRY\)](#) [▶ page 64].

Sterile container: In Universal-B, MELAG recommends a drying time of 13 min with a full load and the use of a sterile container including a silicone mat. Adjust the drying time depending on the load.

***) The Prion-Program provides an extended [plateau period](#) at 134 °C to help reduce the risk of prion transmission - particularly when users comply with the applicable national or institutional requirements for handling potential prion contamination. The Prion-Program does not ensure complete inactivation of prions and does not claim prion inactivation.

Use the Prion-Program only as part of a validated overall reprocessing procedure, including thorough pre-cleaning and, where required, chemical prion decontamination in accordance with the applicable guidelines.

Use the Prion-Program only in accordance with the national or international guidelines applicable to you, e.g. "Hygiene requirements for the reprocessing of medical devices. Recommendation of the Commission for Hospital Hygiene and Infection Prevention ([KRINKO](#)) at the Robert Koch Institute ([RKI](#)) and the Federal Institute for Drugs and Medical Devices ([BfArM](#))" (2012, PMID: 23011095; German national guideline).

Always discard reusable medical instruments that have been in contact with high- or medium-risk tissue from patients with suspected or confirmed Creutzfeldt-Jakob disease - whether owned or borrowed. Prion proteins may be resistant to conventional sterilization processes!

Starting the program

The following must be fulfilled or present:

- ✓ The sterile filter and the dust filter are attached to the device.
- ✓ The load has been cleaned and disinfected, see [Preparing the load](#) [▶ page 31].
- ✓ The feed water container is filled with sufficient feed water, see [Technical data](#) [▶ page 82].
- ✓ The device is loaded correctly, see [Loading the steam sterilizer](#) [▶ page 32].
- ✓ The max. load quantity has not been exceeded, see [Selecting the program](#) [▶ page 33].
- ✓ The date and time are set correctly, see [Date](#) [▶ page 51] and [Time](#) [▶ page 52].

1. In the main menu, press **Programs**.

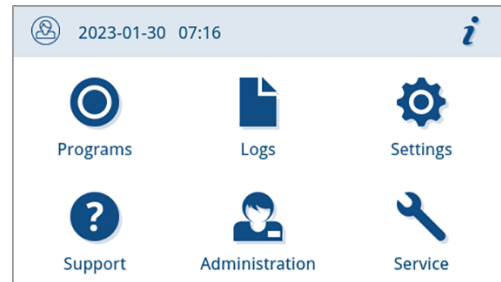

2. Select the program in the menu.



↳ The view changes to the program view. This informs you which type of load the program is suitable for before a program start.

3. If desired, press  to set the drying time, see [Program options](#) [▶ page 35].

4. Press **START PROGRAM** in the program view.



↳ When the program starts, the device checks the conductivity.

PLEASE NOTE: When starting a program for the first time and after changing the feed water container, there may be a brief increase in noise. This ends as soon as feed water reaches the device again.

Program options

Before a program start, the drying time can be individually adjusted depending on the load quantity and type. This adjustment is saved for the current program run to be started, while the general drying settings are retained. For further information on setting the drying time, see [Drying \(flexDRY\)](#) [▶ page 64].

Time-controlled drying

If you would like to change the drying time for this program run, proceed as follows:

1. Press  in the program view.



2. Change the drying time by pressing .

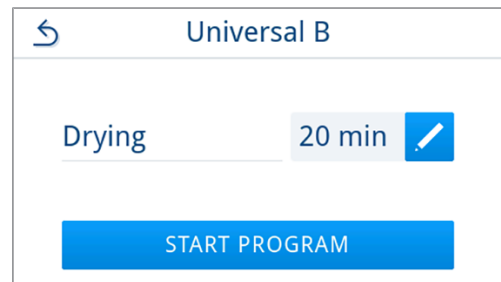

↳ The view for editing the setting opens.

3. Press  or  to select the desired drying time.

PLEASE NOTE: The drying time can be adjusted between 1-60 min.



4. Then confirm with **OK** to accept the selection.

↳ The edited setting is displayed.

5. Press the **START PROGRAM** button to start the program.

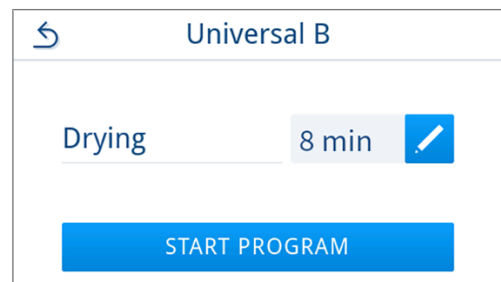

↳ The setting only applies to the selected program run. It is not permanently active.

Program in progress

After program start, you can follow the program run on the display. During program execution, the following values are displayed:

- ▶ **Program run display:**
 - a) Program parameter
 - b) Program name
 - c) Program phase
 - d) Remaining run time (remaining program duration in minutes)
 - e) Expected end of program

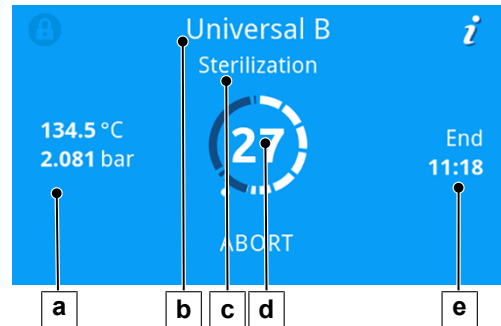

Program is ended

Program successful

If the program was successful, the corresponding message will be issued on the display. The status LED (left LED) below the display lights up green and an acoustic signal sounds once.

1. Press **UNLOCK DOOR**.

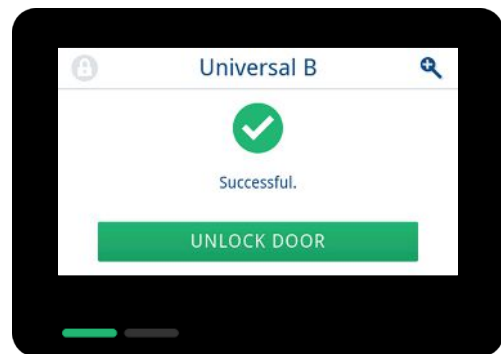

2. Open the door carefully and not forcibly.



If automatic log output after the end of the program is activated in the **Settings** menu (= immediate output), the log of the run program is output to the activated output media after the door is opened.

Program not successful

⚠ WARNING

Warning of contamination

If the safety LED (right LED) lights up red, the program was not completed successfully. The load was not sterilized.

- Check the display and the two LEDs at the end of each program.
- Read and follow the instructions on the display.
- Re-wrap and repeat the sterilization for the respective load if necessary.

If the program was not successful, the corresponding message will be issued on the display. The two LEDs below the display light up red and an acoustic signal sounds three times.

1. Press **UNLOCK DOOR**.

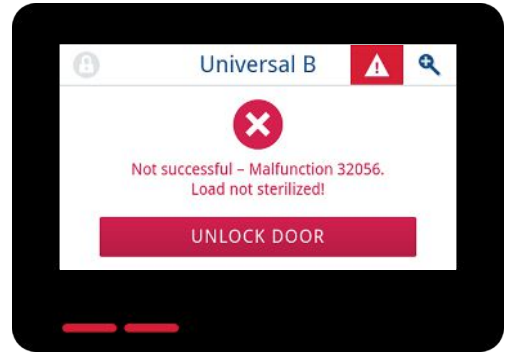

2. To confirm an unsuccessful program run, follow the instruction on the display and press the corresponding button.

In the example view, the A button must be pressed to confirm!

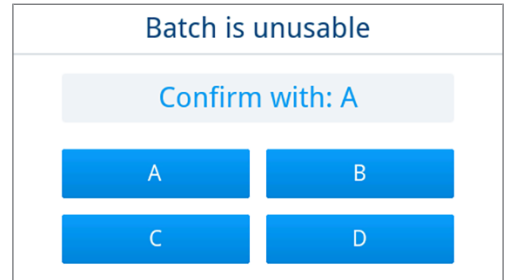

↪ If the entry is incorrect, the entry must be repeated.

3. Open the door carefully and not forcibly.



↪ The load was **not** sterilized. If necessary, wrap the load again and repeat the program.

If automatic log output after the end of the program is activated in the **Settings** menu (= immediate output), the log of the run program is output to the activated output media after the door is opened.

Ending the program prematurely

You can end the program prematurely. If you abort the program before the end of the drying phase, the load is not completely dried and should be used immediately.

The following must be fulfilled or present:

- ✓ The sterilization program is in the drying phase.

1. Press **END** to end the current program.



2. Confirm the security query with **YES**.

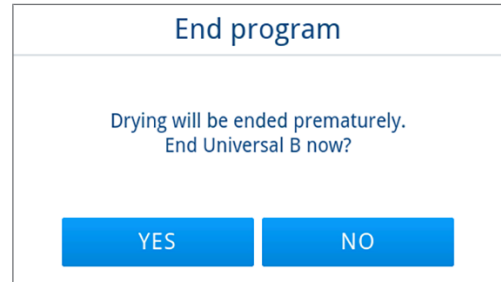

3. Wait until the program has finished.

↳ After successful completion of the program, the status LED (left LED) lights up green and an acoustic signal sounds once.

4. Press **UNLOCK DOOR**.

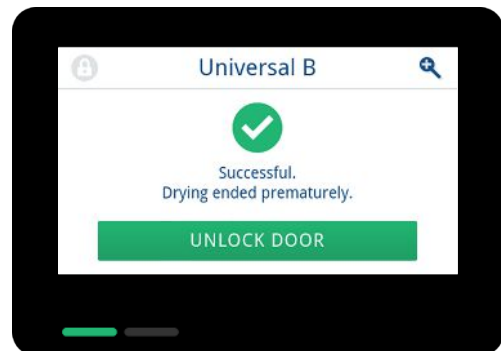

5. Open the door carefully and not forcibly.



Manual program abort

You can abort a current program in all phases. If you abort the program before the end of the sterilization phase, the load is **not** sterile.

⚠ WARNING

Warning of contamination

If a program is terminated before drying starts, the load is **not** sterile.

- Re-wrap the load if necessary.
- Repeat the sterilization of the load.

⚠ CAUTION

Warning of scalding

On opening the door, steam and hot water can escape from the sterilization chamber. e.g. if it is necessary to open the door immediately after the end of a program. This could result in scalding.

- Should steam be issued from the rear of the device after its deactivation, wait until the procedure has finished. Wait a further 5 min before opening the door.
- Stand to one side of the door and maintain sufficient distance.
- Allow the sterilization chamber to cool before removing the load.

1. Press **CANCEL** to abort the running program.

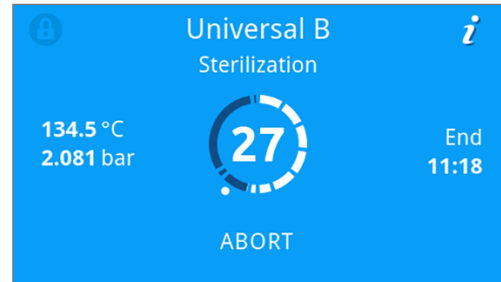

2. Confirm the security query with **YES** and wait until the program abort has been carried out.



➔ The program will be classified as unsuccessful. The load was not sterilized. Both LEDs light up red.

3. Press **UNLOCK DOOR**.

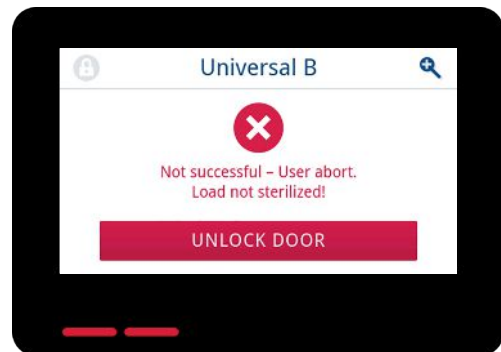

4. To confirm an unsuccessful program run, follow the instruction on the display and press the corresponding button.

In the example view, you must confirm with button A!

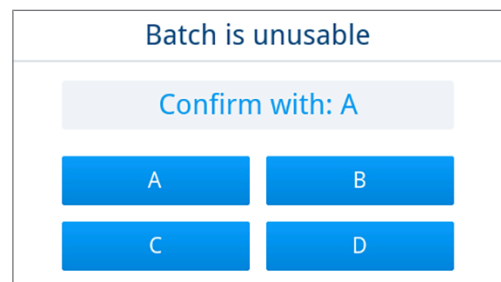

➔ If the entry is incorrect, it must be repeated.

5. Wait for the pressure equalisation.

PLEASE NOTE: If the pressure equalisation is not yet finished, a corresponding note is shown on the display.

- 6. Open the door carefully and not forcibly.



→ The load is **not** sterile. If necessary, wrap the load again and repeat the program.

Removing the sterile material

⚠ WARNING

Warning of contamination

If packaging is damaged or has burst after sterilization, the instruments are unsterile.

- Re-wrap the load.
- Carry out the sterilization again.

⚠ CAUTION

Warning of burns

After a program cycle, the sterilized items are hot. There is a risk of burns from hot parts and hot condensate during removal.

- Never touch the sterile material, the sterilization chamber, the mount or the inside of the door with bare hands.
- Use a tray lifter or heat protection gloves to remove the load.

If you remove the **sterile material** from the device directly after the end of the program, it is possible that the instruments can be partially damp. According to the red brochure of the Arbeitskreis für Instrumentenaufbereitung (AKI), single drops of water (no puddles) that dry off within 15 min are considered tolerable residual moisture in practice.

Comply with the following specifications when removing the sterile material:

- Never use force to open the door. This could damage the device or result in the emission of hot steam.
- Keep the trays horizontal when removing them from the device. Otherwise, the load could slide off.
- When removing individual load holders, make sure that the rest of the load does not slip out.
- Never touch the sterile material, the sterilization chamber or the inside of the door with bare hands. The components are hot.

Attaching the tray lifter correctly

- ▶ To remove the tray from the sterilization chamber, attach the tray lifter as shown.

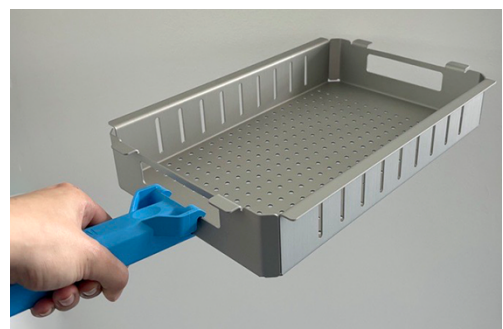

Storing sterile material

The maximum storage time is dependent on the packaging and the storage conditions. Please observe the regulatory requirements for the storage period of [sterile materials](#) (in Germany e.g. [DIN 58953](#), Part 8 or the [DGSV](#) guidelines) as well as the following listed criteria:

- Follow the manufacturer's instructions on the packaging, e.g. when setting the storage period at the label printer. Comply with the maximum storage duration in accordance with the packaging type.
- Store the sterile material in a dust-protected environment e.g. in a closed instrument cabinet.
- Store the sterile material in an environment protected against moisture.
- Store the sterile material in an environment protected against excess temperature variations.

9 Logging

Batch documentation

The batch documentation serves as proof of the successful conclusion of the program and represents an obligatory part of quality assurance. The device internal log memory saves such data as the program type, ▶batch and process parameters of all the programs completed.

To obtain the batch documentation, you can output the internal log memory and transfer its data to various output media. This can be performed immediately at the end of every program or at a later point, such as at the end of the day.

Capacity of the internal log memory

The device is equipped with an internal log memory. This saves all the data regarding the programs automatically. The capacity of the internal log memory is sufficient for 100 logs.

If the internal log memory is full with logs that have not been output, a corresponding message appears on the display. If this is the case, you should provide the specified output medium and output the relevant logs. If the program is continued, the oldest log is automatically overwritten.

MELAG recommends immediately outputting logs automatically, see [log output](#) ▶ page 57].

Logs menu

The **Logs** menu provides you with the following options:

- Display and output of program logs
- Display and output of fault logs
- Output of status logs
- Output of system logs

Log types

Log type	Description
Program log	Log of a program
Malfunction log	Log with faults that occurred outside a program run
Status log	Summary of all important settings and system statuses
System log	List of all the malfunctions and changes to the system in order of time (log book)

You can issue logs subsequently and independently of the time of a program end. Before the log output, you can select the output media.

List of logs

All logs of the internal log memory are displayed in a log list depending on the log type. The list is sorted by date (and time), i.e. the newest log is always added at the top of the list. You can navigate up and down within the list.

- ▶ **Program log list:**
 - a) Program result (successful/unsuccessful)
 - b) Log output status (dot = log not output)

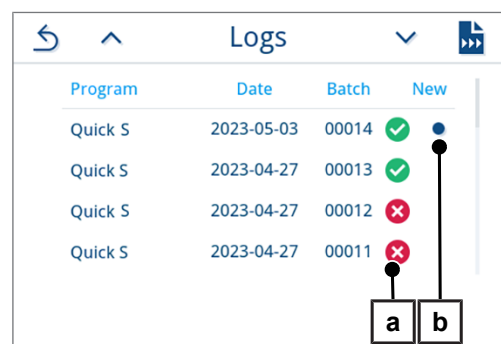

Subsequent log output

The following must be fulfilled or present:

- ✓ At least one output medium is connected and activated, see [Log output](#) [▶ page 57].

1. In the main menu, press **Logs**.

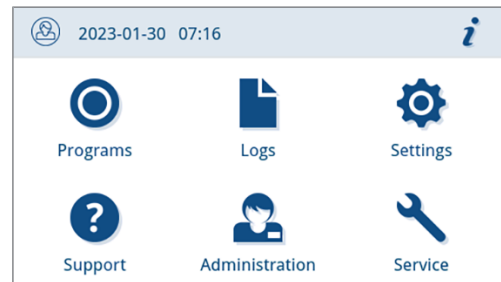

2. Select the log type to view and output single or multiple logs of a log type. To output all program/malfunction and status logs stored on the device, use the **Output all** function in the log menu.

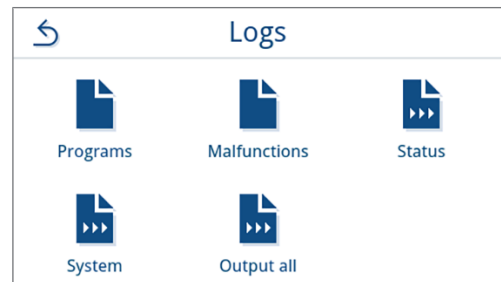

3. Press in the log list to output several logs of one log type. You can choose to output either the last log, the new logs that have not yet been output or all logs.

Alternatively, you can select a log in the log list to open its log preview and output it.

The example view shows the log list of the log type Programs.

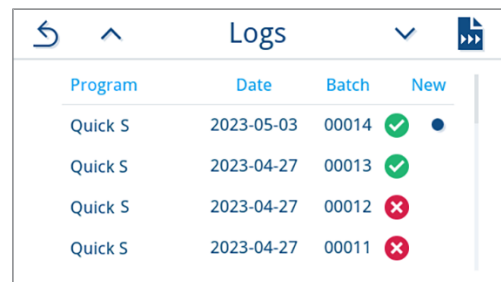

4. Press **OUTPUT LOG** within the log preview.

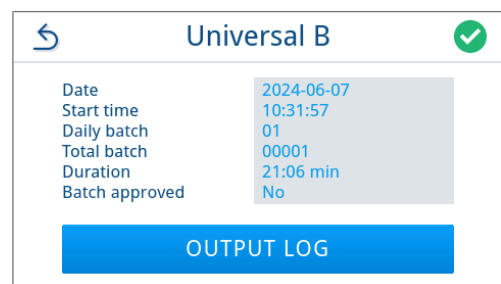

5. Activate the output medium (multiple selection possible) and press or if applicable to have further output media (if available) displayed in the list.

Press **START** at the end of the list.

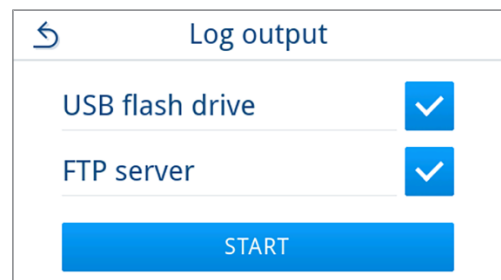

- Follow the progress of the log output on the display.

If the log output was not executed or not completed by pressing **CANCEL**, an unsuccessful/incomplete output result is displayed. This contains the individual output result as a symbol for each output medium.

NOTICE! If the USB stick is removed prematurely or handled improperly, data loss, damage to the USB stick, the device and/or the software may occur!

- a) Number of logs output
- b) Output medium symbol

Example view with selected output media (USB stick, FTP server).

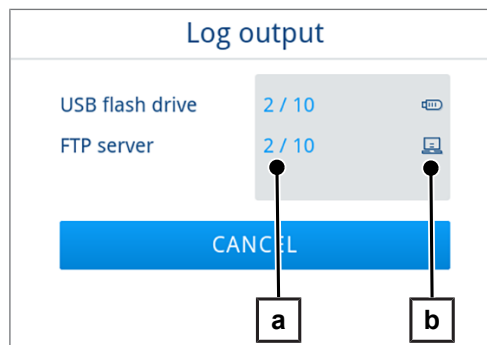

- The result (successful/unsuccessful) is displayed after the log output. Press **OK** to confirm the result.

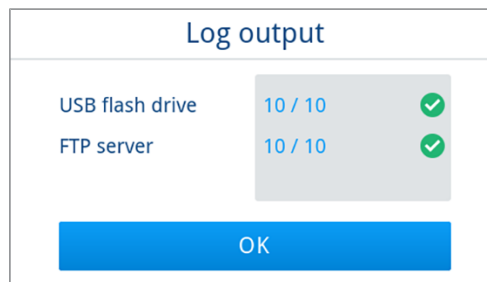

Output media

You are able to output and archive the logs of the completed programs on the following output media:

Symbol	Output medium	Description
	FTP server	Output to an FTP server
	MELAprint 80	Output of logs to a connected printer
	USB flash drive (rear of the device)	Storage on a USB flash drive
	MELAt race	Output to MELAt race

PLEASE NOTE

You can only connect one USB storage medium.

Displaying logs on the computer

The log files are generated in HTML format and can be displayed and printed on the computer with a web browser or in MELAtrace.

The program logs contain a legend entry for each line. The program logs contain graphic data and can be displayed as graphic logs in MELAtrace.

PLEASE NOTE: The log files are provided with a proof of authenticity to identify tampering.



Example log

010	File name	2024-03-28_00003_20211050042_UNI_OK_204F0180003			
020	Device type	Vacuclave 105			
030	Program name	Universal B			
035	Program type	134 °C wrapped			
040	Date	2024-03-28			
045	Daily / total batch	01 / 00003			
070	Program result	Program successfully completed			
141	Sterilization temperature	134.9 +0.22/-0.36 °C			
143	Sterilization pressure	2.10 +0.02/-0.03 bar			
144	Plateau time	05 min 30 s			
150	Conductivity	1.0 µS/cm			
155	Start time	07:37:10			
156	End time (Duration)	07:52:12 (15:02 min)			
160	Serial number	20211050042			
ID	Step	Start [m:s]	Duration [m:s]	P [mbar]	T [°C]
SP-S	Program start	00:00	00:00	1013	44.7
SF12	Fractionation 1 Evacuation	00:00	00:46	325	52.3
SF13	Fractionation 1 Pressure build-up	00:46	00:59	1501	103.0
SF14	Fractionation 1 Conditioning	01:45	00:20	1545	104.1
SF21	Fractionation 2 Outflow	02:05	00:08	1048	99.2
SF22	Fractionation 2 Evacuation	02:13	00:38	300	75.0
SF23	Fractionation 2 Pressure build-up	02:51	00:31	1500	110.7
SF24	Fractionation 2 Conditioning	03:22	00:20	1511	111.0

10 Function checks

Service programs

Overview of service programs

Program	Use/function
Vacuum test 	For measuring the leakage rate, test with a dry and cold device (without load) Vacuum test chamber: • Measurement of the leakage rate in the chamber Vacuum test cooler: • Measurement of the leakage rate in the chamber and in the cooler Vacuum test pump: • Measurement of the leakage rate in the chamber, in the cooler and in the vacuum pump
B&D/Helix test 	Steam penetration test with special test package or PCD test (e.g. Helix test body; available from specialist dealers)

Vacuum test

The device can be checked for leakages in the steam system using the ▶vacuum test. This determines the leakage rate at the same time.

Perform a vacuum test in the following circumstances:

- Once a week in routine operation
- During commissioning
- Following longer operating pauses
- In the case of a corresponding malfunction (e.g. in the vacuum system)

PLEASE NOTE

Perform the vacuum test with the device in a cold and dry state.

1. Switch on the device.
2. Select **Vacuum test chamber** in the **Programs** menu.

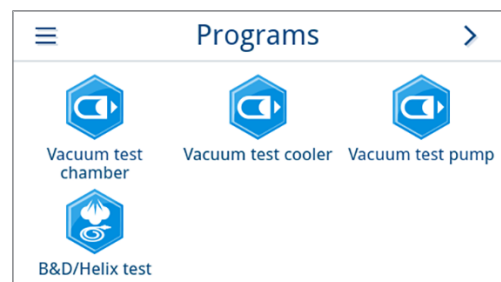

3. Press **START PROGRAM**.



- Wait until the vacuum test has finished. During the vacuum test, the evacuation pressure, the temperature and the expected end of the vacuum test are shown on the display.

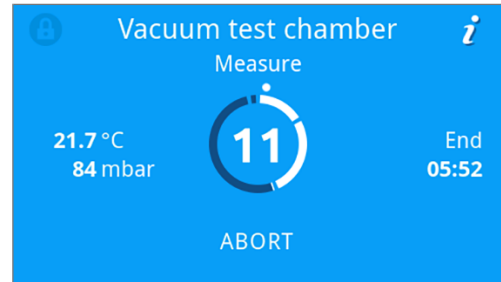

- The sterilization chamber is ventilated after the end of the measuring time. Then the message will be shown on the display with an indication of the leakage rate. After successful completion of the program, the device status LED (left LED) lights up green and an acoustic signal sounds once.

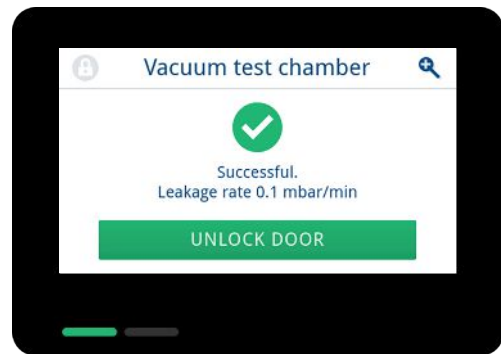

- Should the leakage rate be too high i.e. over 1.3 mbar, a corresponding message will be issued on the display. Both LEDs light up red. Repeat the vacuum test when the sterilization chamber has cooled down again or contact the authorised technician.

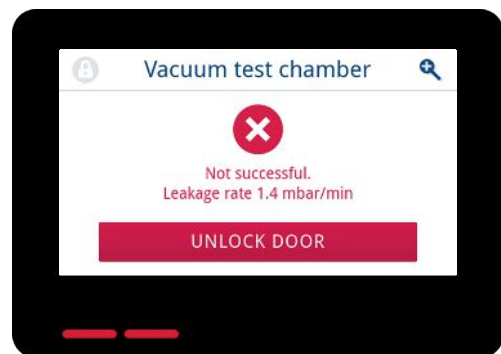

Steam penetration test

The Bowie & Dick test/Helix test serves the verification of the steam penetration of porous materials such as textiles. You can perform a routine function check for proof of steam penetration.

Specialist stockists provide various test systems for the Bowie & Dick test / Helix test. Perform the test according to the test system manufacturer's specifications.

The following must be fulfilled or present:

- ✓ There is a new test system.
 - ✓ The sterilization chamber is empty.
- Place the test system in the sterilization chamber according to the manufacturer's instructions.
 - Close the door.
 - Select the program **B&D/Helix test** in the **Programs** menu.

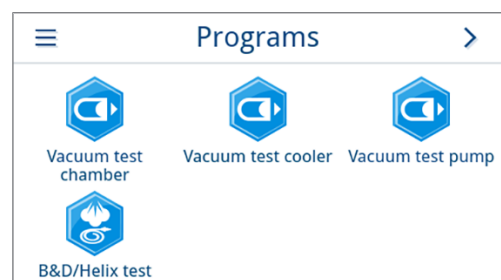

4. Press **START PROGRAM**.

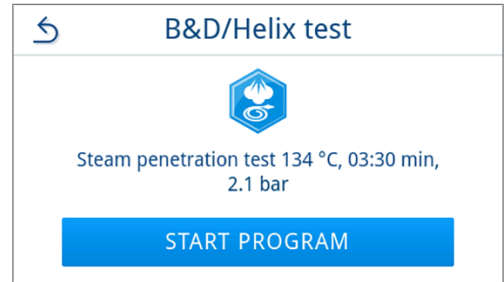

11 Settings

Parameters such as language, date, drying etc. can be set in the submenus of the **Settings** menu.

1. In the main menu, press **Settings**.

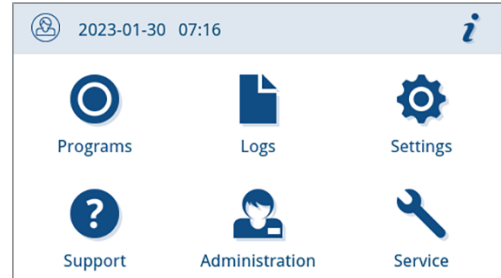

2. Make settings in the corresponding submenus.

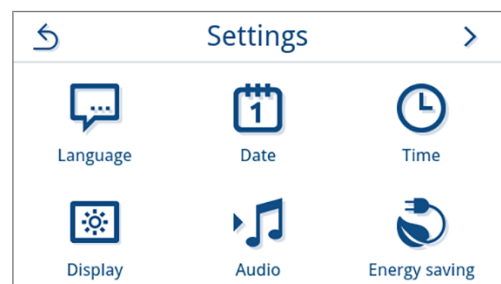

➔ After saving, settings are immediately applied and the view changes from the respective submenu back to the **Settings** menu.

➔ It is not necessary to restart the device.

Discard changed settings

1. Press **↶** without saving in the header area of the respective submenu to cancel a selection or entry made.

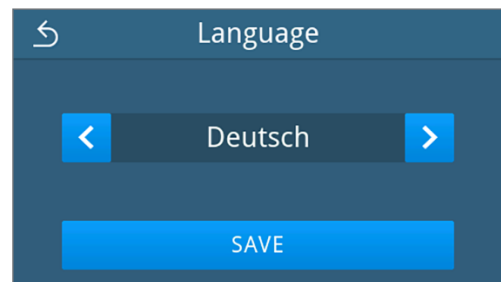

2. Select **YES**.

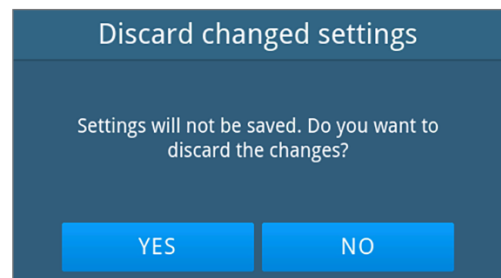

➔ The view changes from the respective submenu back to the **Settings** menu.

➔ If settings are cancelled before saving, the previous parameters remain unchanged.

General settings

General settings can be changed by any user.

Language

You can switch between the enabled languages in the Language submenu.

1. Press **Language** in the **Settings** menu.

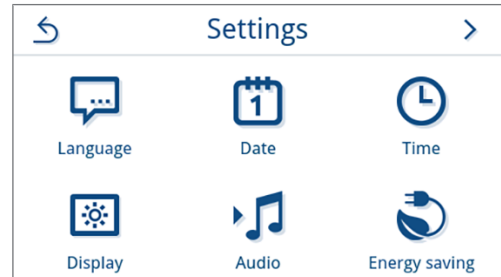

2. Select the desired language using **<** or **>**.
 ↳ After a setting has been changed, the **SAVE** button is active.
3. Confirm with **SAVE**.

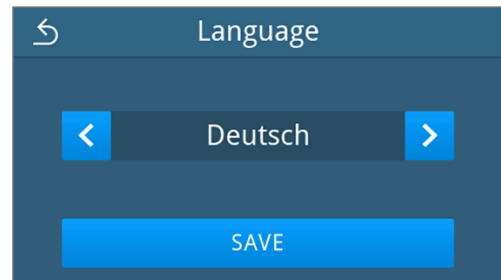

↳ The dialogues on the display and the log texts are changed to the selected language. The view switches back to the **Settings** menu.

Date

The date of the device must be correctly set for proper batch documentation. Set the date as follows:

1. Press **Date** in the **Settings** menu.

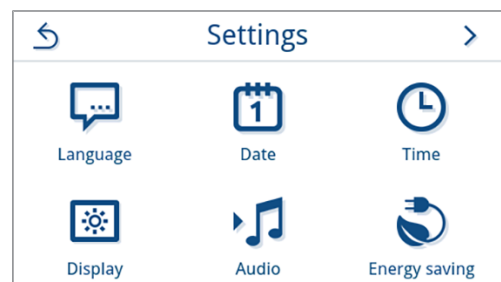

2. Press .

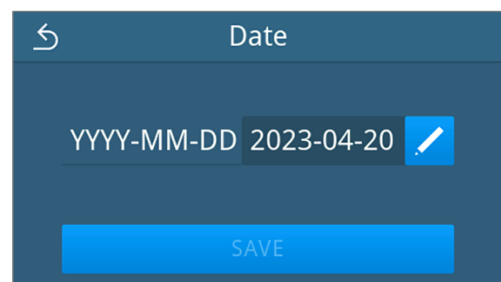

↳ The calendar view opens.

3. Select the correct date in the calendar.
Press **^** (past) or **v** (future) to select the month.

Tip: Long press = 1-year increments



➔ After a setting has been changed, the **SAVE** button is active.

4. Press **SAVE**.

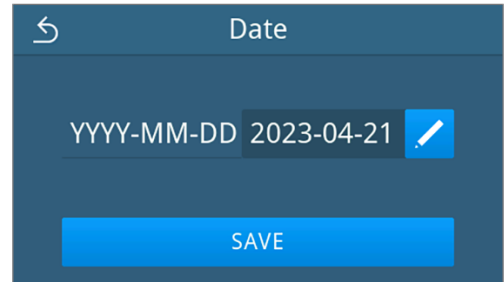

➔ The view switches back to the **Settings** menu.

Time

The time of the device must be correctly set for proper batch documentation. Ensure that you take into account any clock change, as this is not adjusted automatically. Set the time as follows:

1. Press **Time** in the **Settings** menu.

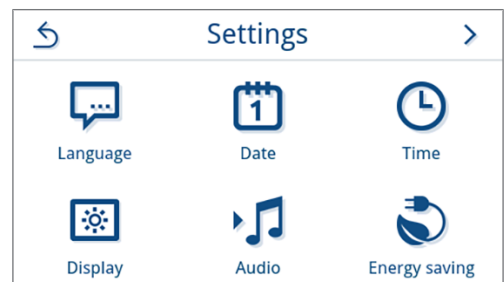

2. Press **[edit icon]**.

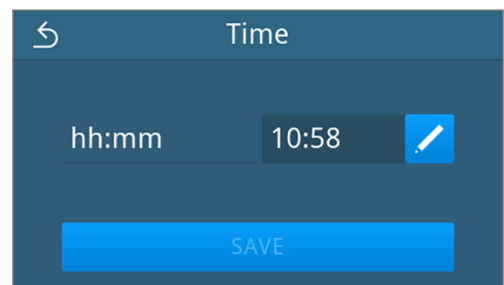

3. Set the correct time using **<** or **>** and confirm with **OK**.

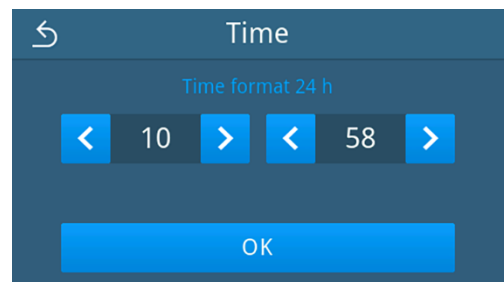

➔ After a setting has been changed, the **SAVE** button is active.

4. Press **SAVE**.

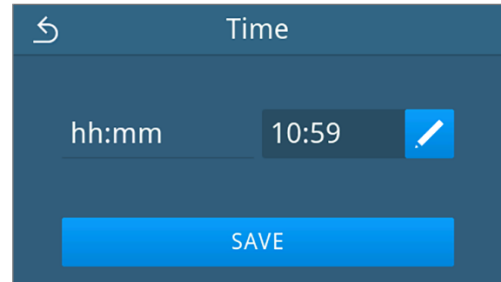

→ The view switches back to the **Settings** menu.

Display

Individualise the display brightness.

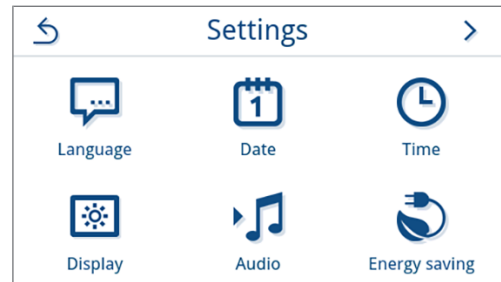

1. Press **Display** in the **Settings** menu.

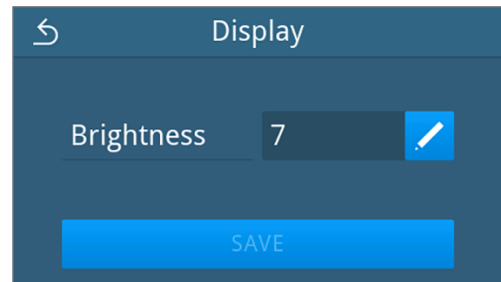

2. Press .



3. Press one of the buttons to change the brightness of the display. The display brightness can be adjusted in several steps.

-  Set the display darker
-  Set the display brighter

The colour bar below the value display gives you an impression of the colour contrast. The brightness is adjusted immediately.

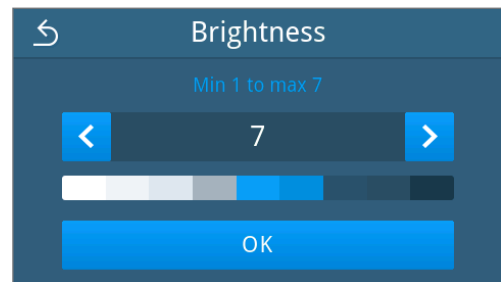

4. Press **OK** to confirm the setting.

→ After a setting has been changed, the **SAVE** button is active.

5. Press **SAVE**.

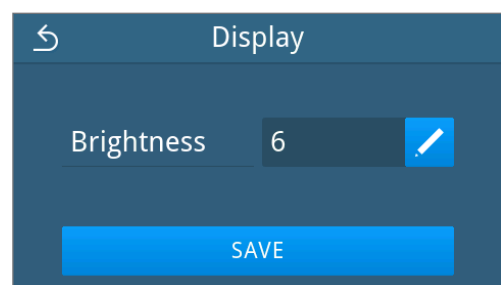

→ The view switches back to the **Settings** menu.

Audio

You can activate (ON) or deactivate (OFF) the signal tones in the **Audio** submenu. The signal tones are activated by default.

1. Press **Audio** in the **Settings** menu.

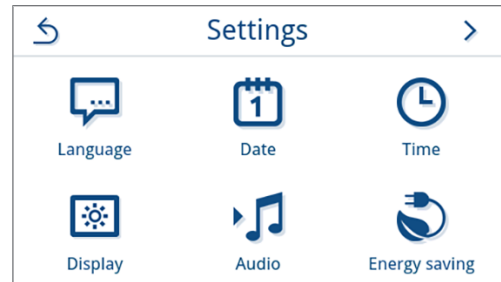

2. Select the desired setting by pressing **OFF/ON**.

➔ After a setting has been changed, the **SAVE** button is active.

3. Press **SAVE**.

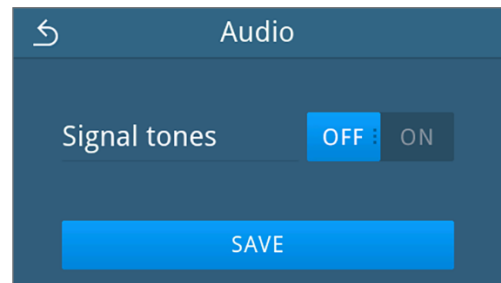

➔ The view switches back to the **Settings** menu.

Energy saving

In energy saving mode you can set an inactive time for the device, after which the preheating and the display are switched off. In the as-delivered condition, energy saving mode is activated after 15 min.

The following functions are deactivated:

- The display is switched off during energy saving mode and is only switched on with a touch.
- When closed, the door is locked and is only unlocked when the display is activated.
- The heater is switched off and is only activated with a program start.

▶ Active energy saving mode is indicated by the permanent display of the  button in the header of the display.

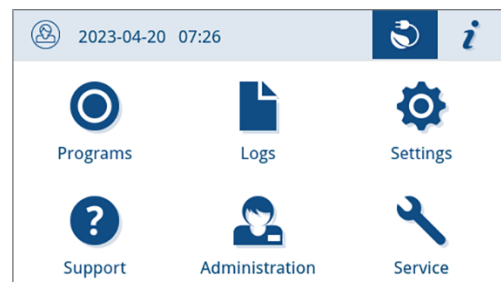

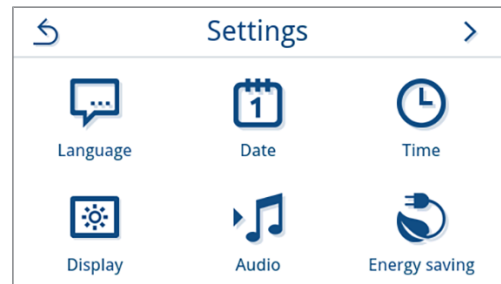

Setting the activation period of energy saving mode

1. Press **Energy saving** in the **Settings** menu.

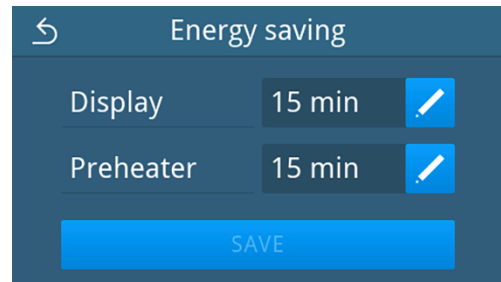

2. In **Display/Preheater**, press .



3. Press  or  to shorten or lengthen the time until energy saving mode is activated.

Tip:

short press = increments of 1
long press = increments of 5

Example view for the display activation period

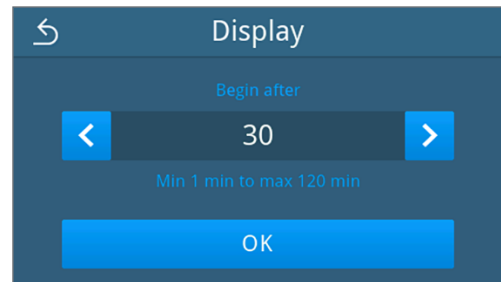

4. Press **OK** to confirm the setting.

➔ After a setting has been changed, the **SAVE** button is active.

5. Press **SAVE**.

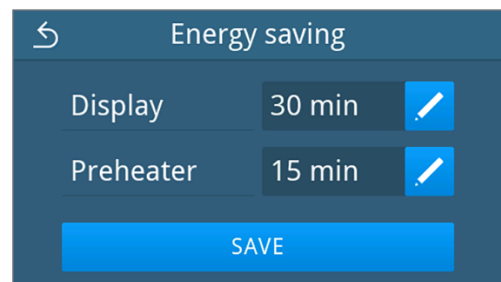

➔ The view switches back to the **Settings** menu.

Manually end active energy saving mode

When a program start occurs, energy saving mode is automatically ended. Alternatively, energy saving mode can also be ended manually as follows:

1. Press the switched off display if necessary.

➔ The display is switched on.

PLEASE NOTE: Activating the display does not end energy saving mode.

- Press  in the header to open the information on energy saving.

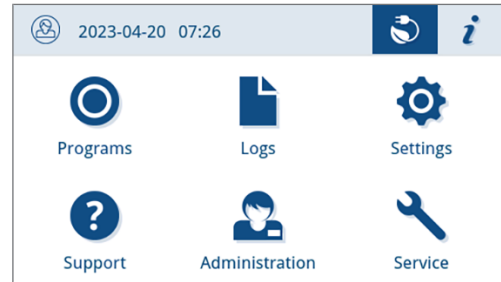

- Press **END ENERGY SAVING**.

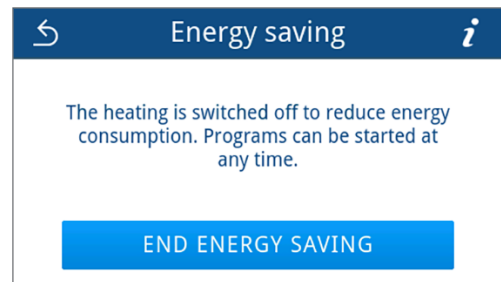

➔ The previous view is displayed again.

Dust filter

You can view the status of the **Dust filter** counter as well as reset it in the dust filter submenu. Replace the dust filter after one year or 1000 cycles at the latest, see [Maintenance intervals](#) [▶ page 71]. For further information on replacing the dust filter, see [Replacing the dust filter](#) [▶ page 74].

- Press **Dust filter** in the **Settings** menu.

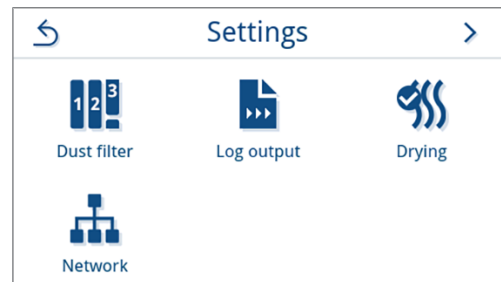

➔ The current counter status is displayed.

- Press **RESET**.

PLEASE NOTE: If the dust filter counter is set to 0, the counter status cannot be reset. The **SAVE** button is inactive.

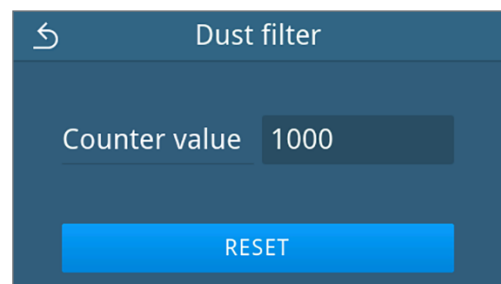

➔ The counter status has been reset to 0.

- Press **SAVE** to accept the counter status.

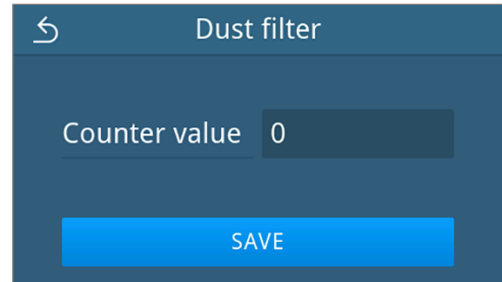

→ The view switches back to the **Settings** menu.

Log output

In the **Log output** submenu, you can set how the log should be output by default for each output medium.

Manual: The log is output subsequently from the device memory.

Automatic: The log is output automatically at the end of the program.

Deactivated: No log output is possible, even with output medium connected.

Log output on a USB flash drive

- Press **Log output** in the **Settings** menu.

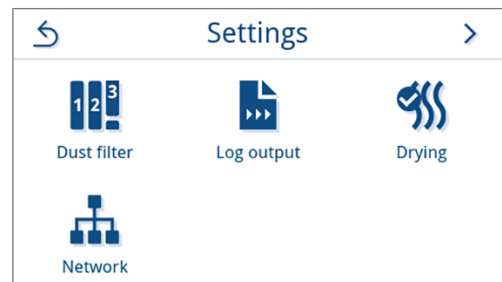

- Press **USB flash drive**.

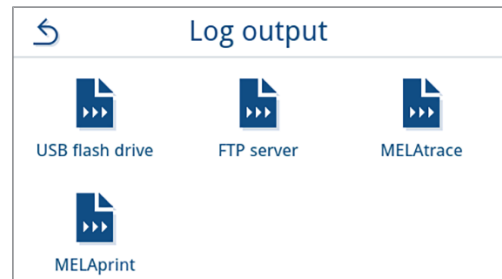

- Press to change the output type.

PLEASE NOTE: Automatic output (immediate output) to a USB flash drive is set by default. An automatic log output of the program/malfunction log is triggered after each program end/malfunction.

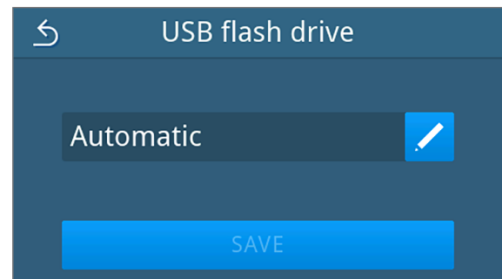

- Select the desired output type by pressing **<** or **>**.
Then confirm with **OK** to accept the selection.



→ The edited setting is displayed.

- Press **SAVE**.

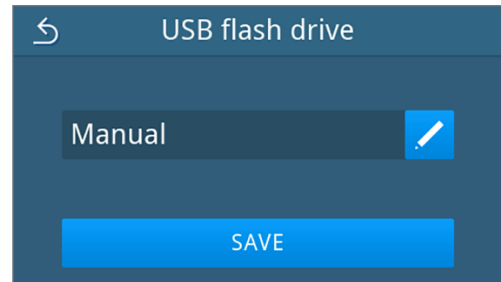

→ The selection has been set as default. The view switches back to the **Log output** submenu.

Log output on a FTP server

Please use *MELAG FTP Server* to set up an FTP server. You can find the program in the download centre on our website at www.melag.com/en/service/downloadcenter. Automatic output to a FTP server is deactivated by default.

- Press the **Log output** button in the **Settings** menu.

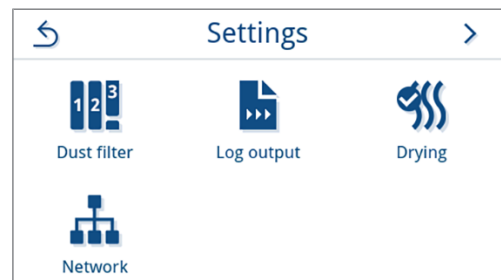

- Press **FTP server**.

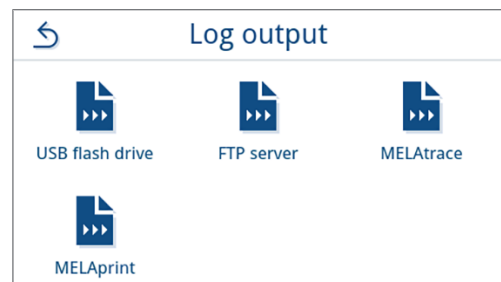

- Change the output type by pressing **✎** in the upper row.

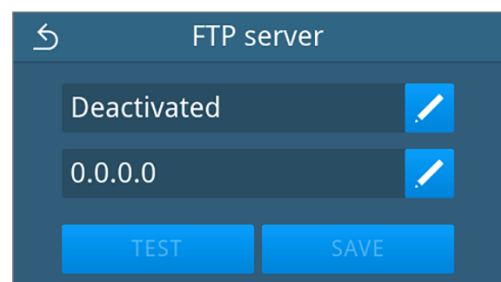

- Select the desired output type by pressing or .

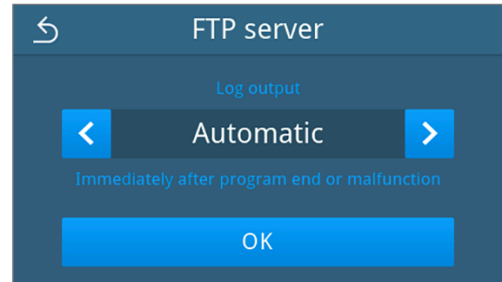

The edited setting is displayed.

- Select this setting and confirm with **OK**.
- Set up the FTP server.

Configure a FTP server

- Configure the FTP server by pressing in the bottom row.

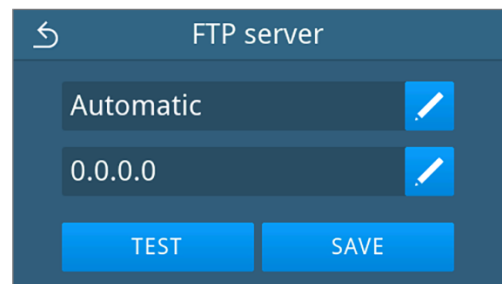

- Enter the IP address and accept the changes by confirming with .



The view for changing the user name is displayed.

- Enter the user name of the FTP server and accept the changes by confirming with .

PLEASE NOTE: If an alternative keyboard is used in your region, you can select your preferred keyboard by pressing .



The password entry view is displayed.

- Enter the password of the FTP server and accept the changes by confirming with .

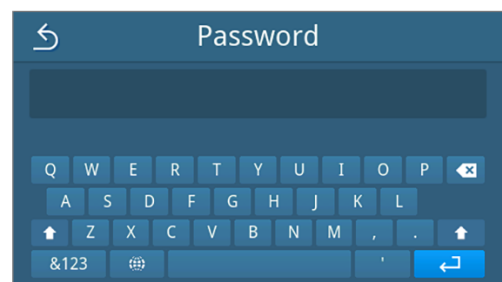

The view for selecting the output type is displayed again.

- After a setting has been changed, the **TEST** and **SAVE** buttons are active. Press **TEST** to check the connection with the FTP server settings.

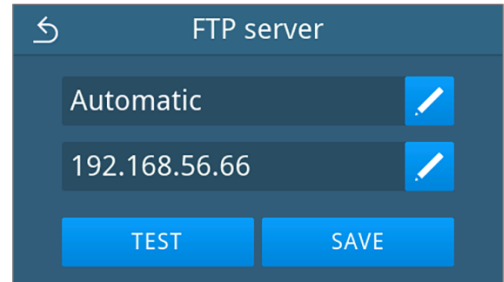

- Confirm with **OK**.

If the connection test fails, check your entries and test again.

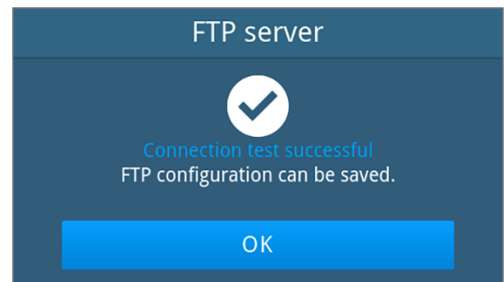

- Press **SAVE**.

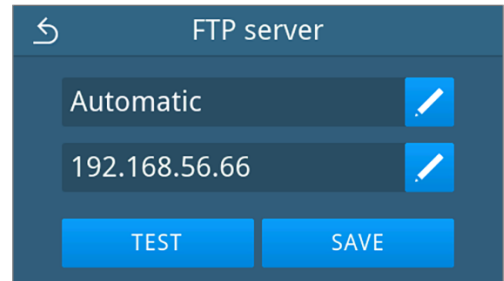

→ The selection has been set as default and the view changes back to the **Log output** submenu.

Log output with MELAtrace

- Press **Log output** in the **Settings** menu.

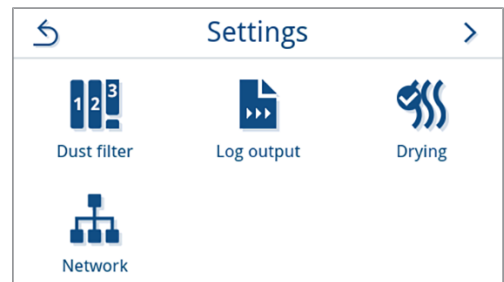

- Press **MELAtrace**.

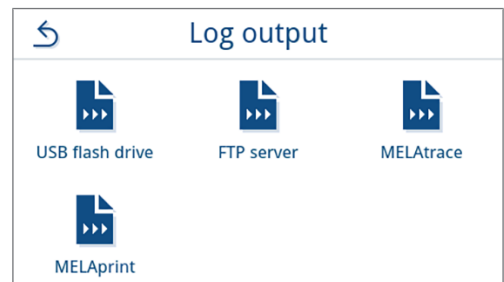

3. Change the output type by pressing .

PLEASE NOTE: Automatic output with MELAtrace is deactivated by default.



4. Select the desired output type by pressing  or .

Then confirm with **OK** to accept the selection.



 The edited setting is displayed.

5. Press **SAVE**.

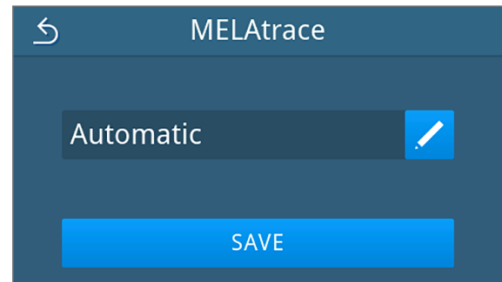

 The selection has been set as default. The view switches back to the **Log output** submenu.

Log output with MELAprint

You can configure the log printer in the **MELAprint** submenu. Connect to a printer via USB or network (LAN). Also select between manual and automatic output or deactivate log printing. Log printing is deactivated by default.

1. Press **Log output** in the **Settings** menu.

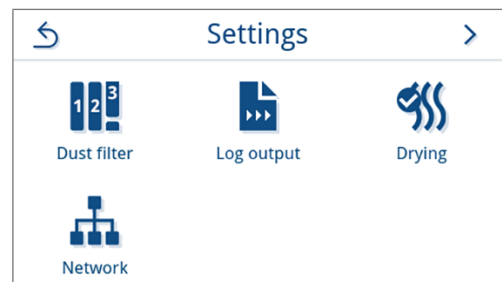

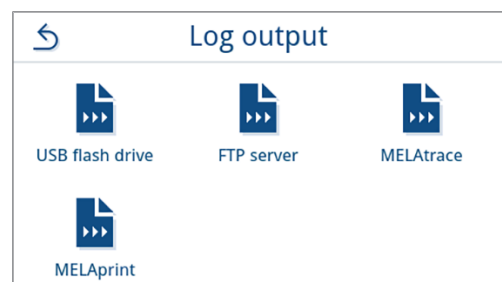

2. Press **MELAprint**.

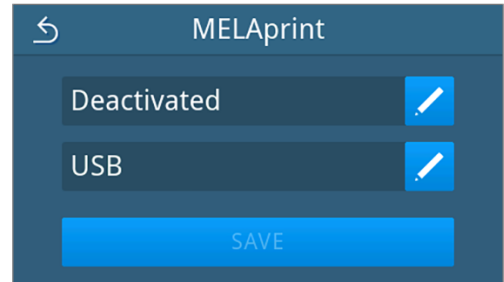

3. Change the output type by pressing  in the upper row.



↳ The view for editing the setting opens.

4. Select the desired output type by pressing  or .
- Then confirm with **OK** to accept the selection.

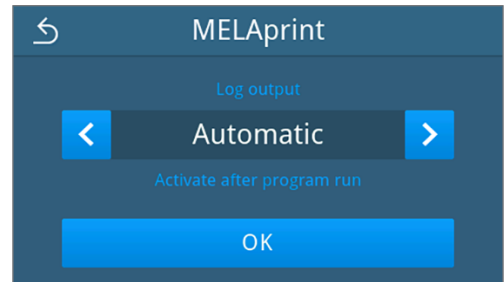

↳ The edited configuration is displayed.



5. Set up the printer, see [Configuring the log printer](#) [▶ page 62].

Configuring the log printer

Printer via USB

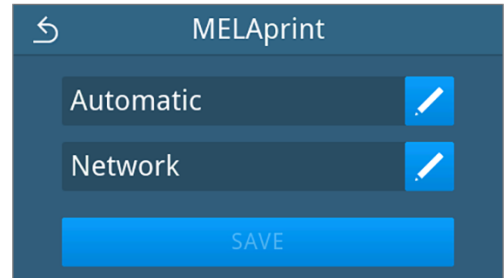
1. Configure the printer by pressing  in the bottom row.



2. Select by pressing  or  **USB**.
- Then confirm with **OK** to apply the selection.

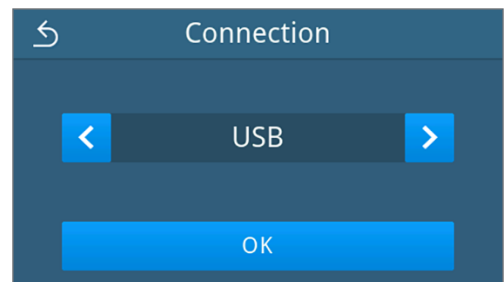

↳ The edited configuration is displayed.

3. Press **SAVE**.

Example view of a selected configuration

→ The selection has been set as default and the view changes back to the **Log output** submenu.

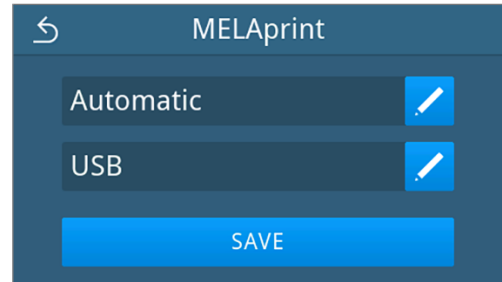

Printer via network

1. Press  in the bottom row to configure the printer.

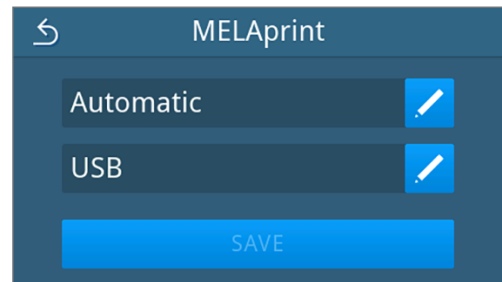

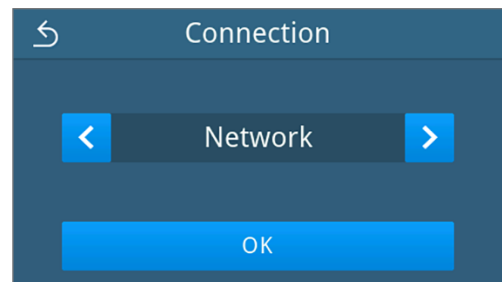

2. Select by pressing  or  **Network**.

Confirm with **OK** to start searching for a network printer.



3. If no printer was found, you can start the search again by pressing **SEARCH AGAIN**.

4. If printers are found on the network, they are displayed in a list with their MAC address for selection.

PLEASE NOTE: If several printers are found in the network, you can scroll through the MAC addresses by pressing  or .

Press  to select the desired printer.

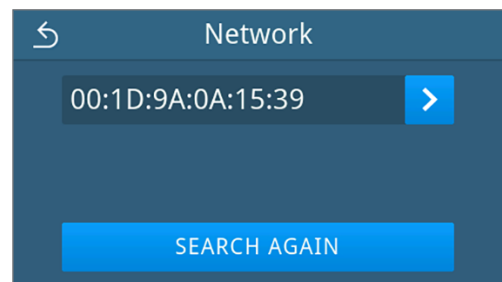

→ The edited configuration is displayed.

5. Press **SAVE**.

Example view of a selected configuration

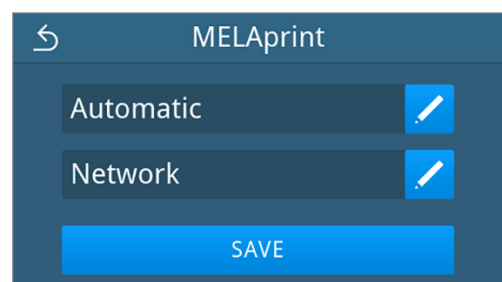

→ The selection has been set as default and the view changes back to the **Log output** submenu.

Drying (flexDRY)

The program-specific drying time ensures excellent drying of the sterile material in most load configurations. If necessary, the drying time can be permanently adjusted to shorten the program run times or to achieve an extended drying time for loads that are difficult to dry.

If you want to change the drying time permanently, proceed as follows:

1. In the **Settings** menu, press **Drying**.

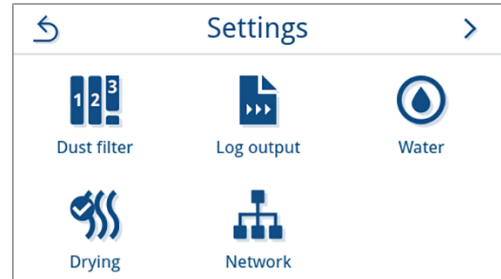

2. Change the drying time by pressing for the corresponding sterilization program.

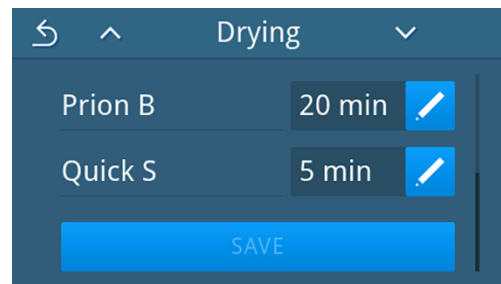

→ The view for editing the setting opens.

3. Select the desired drying time by pressing or .

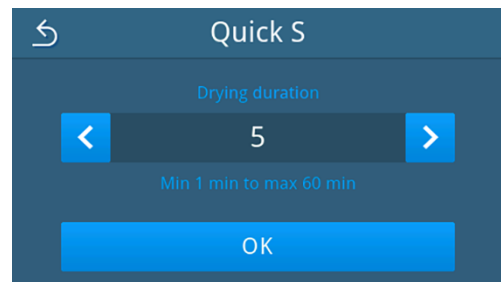

4. Confirm with **OK** to accept the change.
5. Press **SAVE** at the end of the program list.

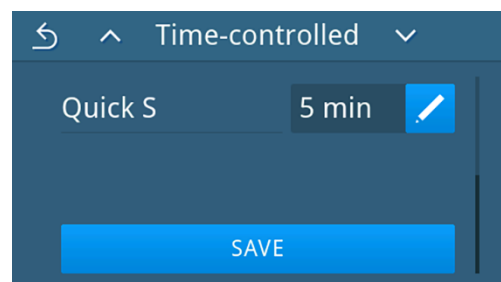

→ The change has been set as default and the view changes back to the **Settings** menu.

Network

You can select an automatic configuration via DHCP or enter the required address details manually. DHCP is activated by default.

Manual (static) entry

1. In the **Settings** menu, press **Network**.

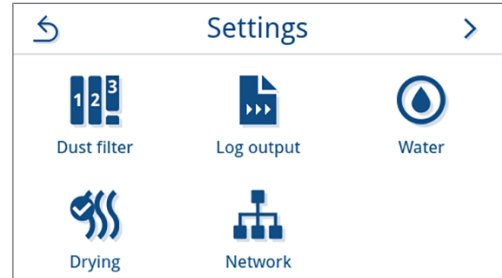

→ The current network configuration view is displayed.



2. The entries are inserted automatically if the device is integrated in the practice network with a DHCP server. If there is no DHCP server, the entries remain empty.

Press  to edit the network settings.

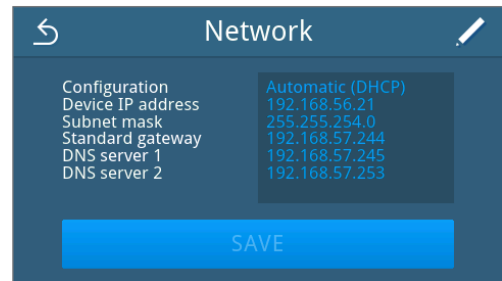
Example view of a network setting



→ The view for editing the network settings opens.

3. Use  or  to select the setting **Manual (static)** and confirm the selection with **OK**.

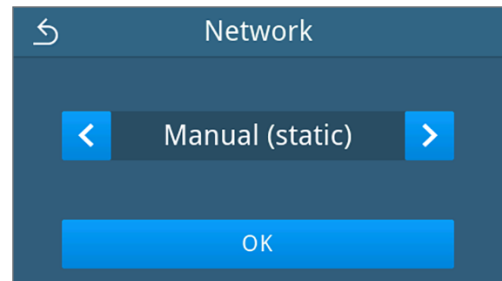

→ The view for editing the IP address is displayed.

4. Enter the IP address of your network and confirm the selection with .

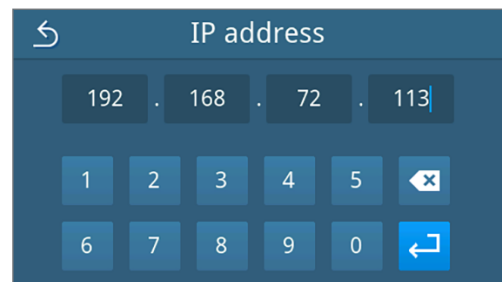

→ The view for editing the subnet mask is displayed.

- 5. Enter the address of the subnet mask of your network and confirm the selection with .



→ The view for editing the default gateway is displayed.

- 6. Enter the address of the default gateway of your network and confirm the selection with .

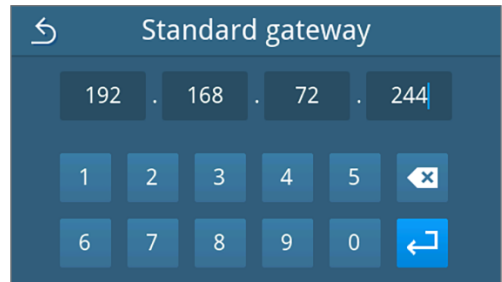

→ The view for editing DNS server 1 is displayed.

- 7. Enter the address of the DNS server 1 of your network and confirm the selection with .

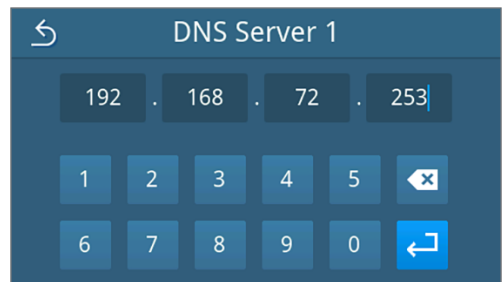

→ The view for editing DNS server 2 is displayed.

- 8. Enter the address of the DNS server 2 of your network and confirm the selection with .

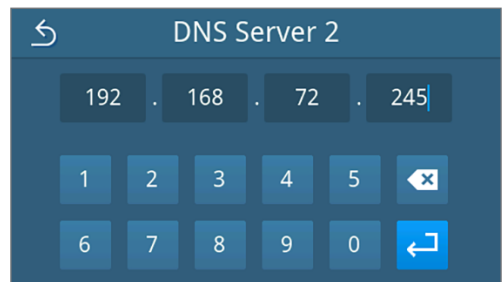

→ The view of edited network settings is displayed.

- 9. Press **SAVE**.

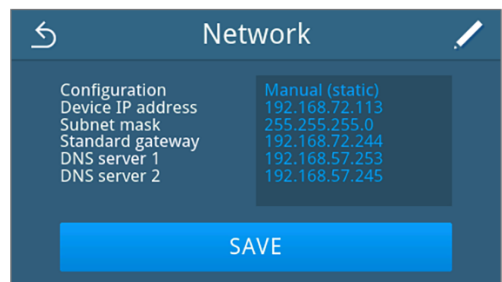

→ The view switches back to the **Settings** menu.

Administrative settings

To make administrative settings, such as changes in user administration, you must log in as an administrator or service technician.

Log in as an administrator or service technician

1. In the main menu, press **Administration**.

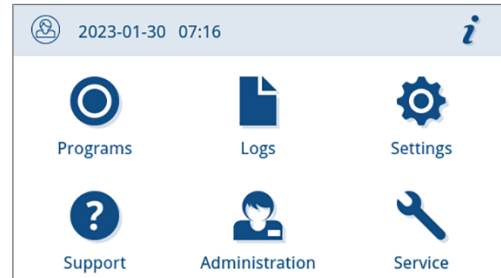

2. Select the desired role, e.g. **Administrator**.

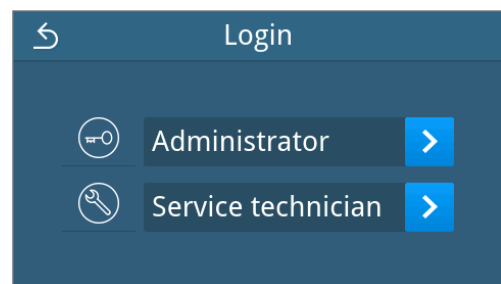

3. Enter the associated PIN.

PLEASE NOTE: When the device is delivered, the admin PIN is set to 1000 by default. MELAG recommends changing the [Admin PIN](#) [▶ page 68] when commissioning the device.

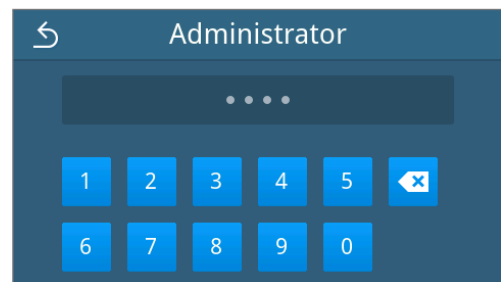

➡ Upon successful login, additional settings are available in the **Administration** menu.

Logging out as an administrator

The following must be fulfilled or present:

- ✓ You are logged in as administrator and are in the **Administration** menu.

1. To exit the **Administration** menu you must log out of the **Administrator** role abmelden.

Press **↶** in the **Administration** menu until the view for logging out as an administrator is displayed.

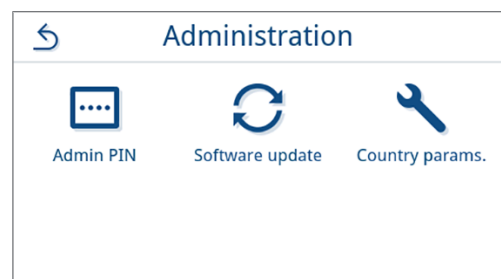

- 2. Press **LOGOUT**.

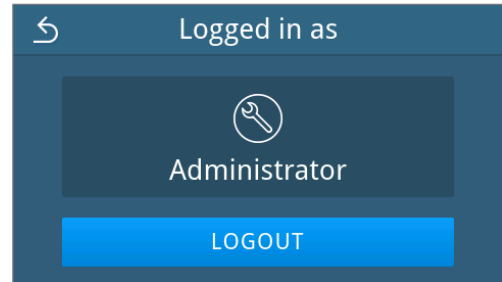

➔ After logging out, the main menu is displayed in the user role "Practice employee".

Admin PIN

When the device is delivered, the admin PIN is set to 1000 by default. MELAG recommends that you change the admin PIN upon commissioning.

PLEASE NOTE If the changed administrator PIN is lost, contact an [authorised technician](#).

The following must be fulfilled or present:

- ✓ You are logged in as an administrator or service technician, see [Log in as an administrator or service technician](#) [▶ page 67].

- 1. Press **Admin PIN** in the **Administration** menu.

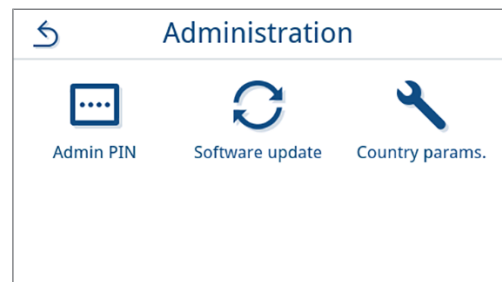

- 2. Press .

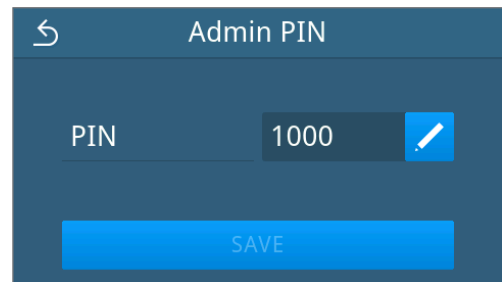

- 3. Enter the new four-digit PIN and confirm with .

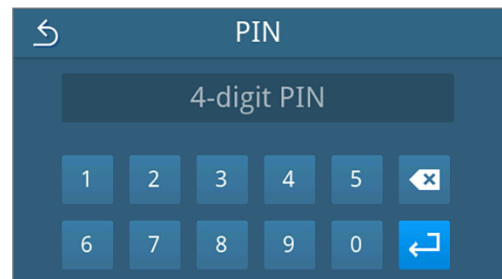

➔ After a setting has been changed, the **SAVE** button is active.

4. Press **SAVE**.

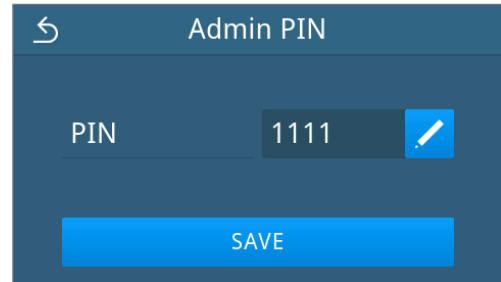

→ The view switches back to the **Administration** menu.

Checking the software version

1. Open the status of the device with **i** in the header of the display.
2. Check the software version.
3. Update the software if necessary, see [Software update](#) [▶ page 69].

Software update

A software update can only be performed by the administrator or ▶[authorised technician](#).

PLEASE NOTE

Warning of data loss

During a software update, all program and malfunction logs are deleted.

- Check whether all required logs have been output to an output medium.
- Please observe the further information in the separate instruction “Information regarding software update and re-installation”. You can find the document and the software in the download centre on our website at www.melag.com.

The following must be fulfilled or present:

- ✓ USB flash drive with the current update files.
- ✓ All logs of the internal log memory are output, see [Subsequent log output](#) [▶ page 44].
- ✓ You are logged in as an administrator or service technician, see [Log in as an administrator or service technician](#) [▶ page 67].

1. In the **Administration** menu, press **Software update**.

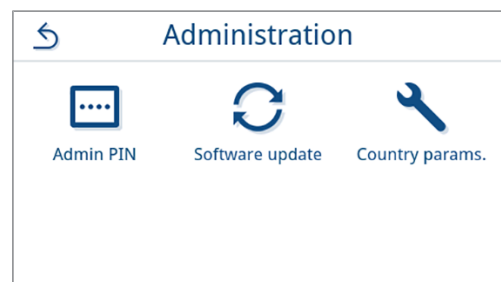

2. Insert a USB flash drive with the installation data in the USB port 1 on the rear of the device.
3. Press **NEXT** to perform the software update.
 - During the software update, the device independently performs one or more restarts.

Country parameters

You have the option of activating and deactivating special sterilization parameters for Japan and the Czech Republic/Slovakia. The parameters are deactivated by default.

The following must be fulfilled or present:

- ✓ You are logged in as an administrator or service technician, see [Log in as an administrator or service technician](#) [▶ page 67].

1. Press **Country parameters** in the **Administration** menu.

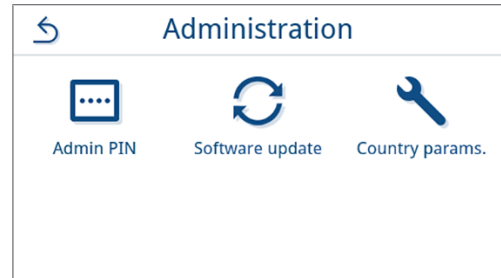

2. Press the respective **OFF/ON** button to deactivate/activate the country parameters.

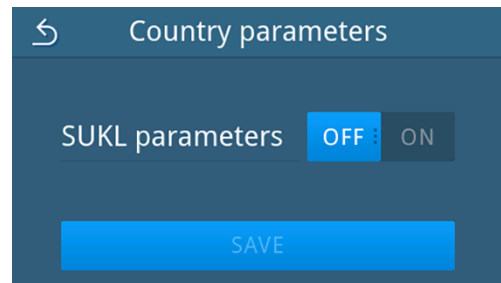

3. After a setting has been changed, the **SAVE** button is active. Press **SAVE** to accept the setting.

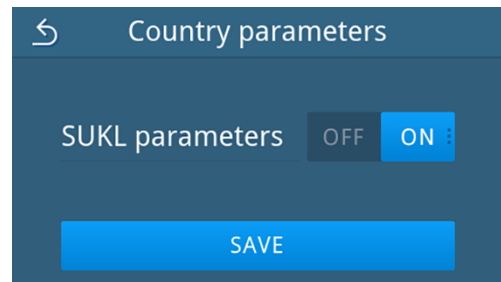

↪ The view switches back to the **Administration** menu.

12 Maintenance

PLEASE NOTE

The user can do the maintenance work described below as part of in-house maintenance.

All maintenance activities beyond this should only be carried out by an [authorised technician](#).

Maintenance intervals

Interval	Measure	Device component
Every time the feed water container is filled up	Check the feed water container for soiling and clean it if necessary before filling Emptying the wastewater container	Feed water container, wastewater container
Daily	Check for soiling, deposits or damage and clean if necessary	Sterilization chamber incl. door seal and chamber sealing, door lock
	Check the operating media feed water, wastewater	Operating media
	Check the output media	USB
Weekly	Chamber vacuum test (in the morning before starting work with a cold and dry device)	Vacuum system
	Clean the surfaces	Housing parts, sterilization chamber, accessories
After 12 months or 1000 cycles	Replacing of the door seal	Door gasket
After 12 months or 1000 cycles	Replace dust filter	Dust filter on the underside of the device
After 24 months or 4000 cycles	Maintenance by the authorised technician working in accordance with the maintenance instructions	Components according to maintenance instructions
As required	Clean the surfaces	Housing parts
After 6 years	Exchange the hoses	Feed water and outlet hose

Cleaning

NOTICE

Warning of material damage from incorrect cleaning

Inappropriately performed cleaning can lead to the scratching of and damage to surfaces as well as the development of leaks in sealing faces. This also favours the development of soiling deposits and [corrosion](#) in the [sterilization chamber](#).

- Comply with all information regarding cleaning of the parts affected.
- Do not use any hard objects for cleaning such as a metal saucepan cleaner or a wire brush.

Sterilization chamber, door seal, inner door surface, trays

To maintain the value of your device and to avoid persistent contamination and deposits, MELAG recommends weekly cleaning of the surfaces. Use the Chamber Protect chamber cleaning set or, if not available, a neutral liquid cleaner or spirit.

PLEASE NOTE: Note the instructions for use of the cleaning agent.

The following must be fulfilled or present:

- ✓ Chamber Protect (if not available: neutral liquid cleaner or spirits)
- ✓ The door is open.
- ✓ The device is switched off and has cooled down completely.
- ✓ Trays were removed from the sterilization chamber.
- 1. Apply the cleaning agent on a lint-free cloth.
- 2. Use a lint-free cloth to uniformly spread the cleaning agent on the surfaces to be cleaned.

PLEASE NOTE: Do not allow cleaning agents to get into the pipes coming from the sterilization chamber.

- 3. Allow the cleaning fluid to act and evaporate for a sufficient time. This may take a few minutes.
- 4. Wet a new lint-free cloth with plenty of demineralised water.
- 5. **NOTICE! Warning of material damage.** Residues of cleaning fluids can ignite or cause deposits on the instruments. Wipe the cleaned surfaces thoroughly. If necessary, wring out the cloth and repeat the process.
- 6. Allow the cleaned surfaces to dry completely. This may take a few minutes.
- 7. Wipe the cleaned surfaces with a dry, lint-free microfibre cloth.

Housing parts

Where necessary, clean the housing parts with a neutral fluid cleaner or spirit.

Comply with the following specifications when disinfecting the housing parts:

- Use wipe disinfectants and not spray disinfectants. This prevents disinfectant from getting into inaccessible places or ventilation slots.
- Only use alcohol-based surface disinfectants (ethanol or isopropanol) or alcohol-free disinfectants based on quaternary ammonium compounds.
- Do not use disinfectants containing secondary and tertiary alkylamines or butanone.

Feed water and wastewater containers

Interval	Measure
Upon every refill	Check the feed water container for soiling. If necessary, clean the feed water container before filling.
Every time it is emptied	Check the wastewater container for soiling. Clean the wastewater container if necessary.
As required	Replace heavily soiled or damaged containers with new ones.

Avoiding staining

Only proper cleaning of the instruments prior to sterilization enables you to avoid residue from being released from the load under steam pressure during sterilization. Loosened dirt residue can clog the filter, fittings and valves of the device and deposit themselves on the instruments and in the sterilization chamber as deposits and stains.

All steam-conducting parts of the device consist of non-rusting material. This rules out the development of rust caused by the device. Any rust which develops is always extraneous rust.

Incorrect instrument reprocessing can result in the accretion of rust even on stainless steel instruments of leading manufacturers. Often, a single instrument which drops rust can suffice to cause the development of rust on other instruments or in the device. Remove foreign rust from the instruments using chlorine-free stainless steel cleaning fluid (see [Cleaning](#) [▶ page 71]) or send the damaged instruments to the manufacturer.

The extent of stain accretion on the instruments is also dependant on the [▶feed water](#) used for steam generation.

Replacing the sterile filter

Comply with the following for safe handling:

- The sterile filter is no longer effective if it has become wet. Stop using the sterile filter and replace it.

The following must be fulfilled or present:

- ✓ A new and dry sterile filter, see [Spare parts](#) [▶ page 83].
1. Open the door.
 2. Unscrew the sterile filter (pos. a) anticlockwise from the holding socket (pos. b).
 3. Replace the sterile filter with a new sterile filter.
 4. Turn the new sterile filter clockwise straight into the holding socket.

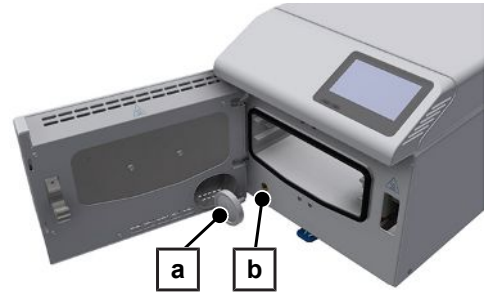

Replacing the door seal

The door seal may not be greased or oiled. Keep the door seal clean and dry. If the door seal shrinks or is wavy, exchange the door seal. Otherwise, this could result in leaks which will enable steam egress, or can cause too high a leakage rate in the vacuum test. Replace the door seal as follows:

1. Remove the worn door seal from the groove.
 2. Check the groove and the door seal for soiling and deposits.
 3. Replace any damaged door seal.
 4. Clean the door seal with gentle commercially available cleaning agent.
 5. Clean the seal groove with e.g. spirit or cleaning alcohol (only chlorine- and vinegar-free cleaning agents) or the Chamber Protect chamber cleaning set.
 6. Place the door seal loosely on the groove.
- PLEASE NOTE:** Make sure the door seal is facing in the correct direction. The upper edge is labelled with an arrow pointing upwards.
7. Press the door seal into the groove in the order indicated.
 8. Press down the locations between these points already inserted into the groove in a cross-wise fashion etc.
 9. Perform a trial run (vacuum test) and then check the stability and position of the door seal. Press the seal into the groove if there are any bulges.

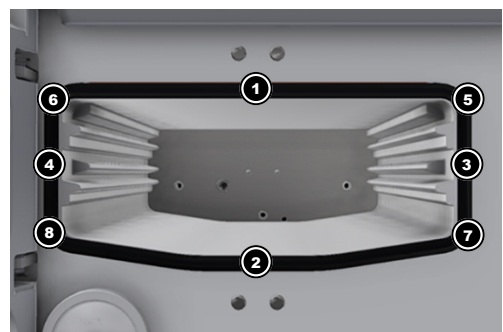

Replacing the dust filter

The following must be fulfilled or present:

- ✓ A new and clean dust filter, see [Spare parts](#) [▶ page 83].
- 1. Open the device door.
- 2. Press down the centre of the grip and pull out the dust filter.
- 3. Insert the new dust filter until it snaps into place. The latch nose of the grip must point upwards.
- 4. Close the device door and reset the counter reading, see [Dust filter](#) [▶ page 56].

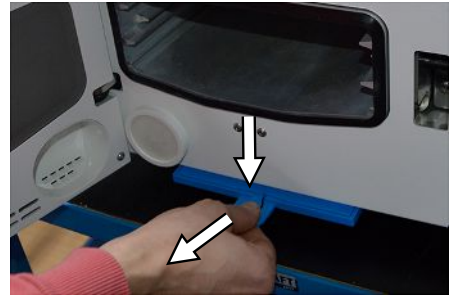

Replacing hoses

Have hoses replaced every 6 years as part of maintenance. If you need to remove a hose from the device beforehand, proceed as follows:

1. Switch off the device at the power switch.
2. Use a suitable tool (e.g. open-end spanner) to push up the quick coupling area of the hose.

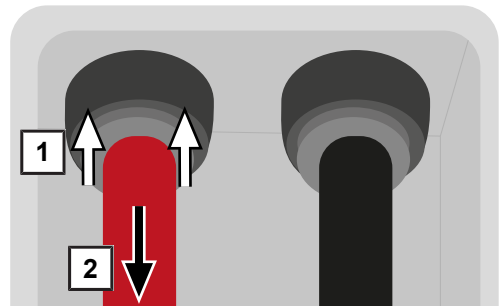

3. At the same time, pull the hose downwards forcefully.

PLEASE NOTE: MELAG recommends that the date of the last replacement be noted on the hose or on the device immediately (e.g. with a label), to ensure that the following replacement is carried out in good time.

Maintenance

Comply with the following for safe handling:

- Maintain the specified maintenance intervals. Continuing operation beyond the maintenance interval can result in malfunctions in the device.
- Have maintenance performed only by trained and authorised technicians using the original MELAG maintenance set.
- If components that are not included in the maintenance set have to be replaced during maintenance, only original spare parts from MELAG may be used for the replacement.

Regular maintenance is vital to ensure reliable operation and value retention of the device. All function and safety-relevant components and electrical units must be checked during maintenance and replaced where necessary.

Maintenance is to be performed after every 4000 cycles, but after 24 months at the latest. At the appropriate time, a warning message is shown on the display.

13 Pause times

Frequency of sterilization

Pause times between individual programs are not necessary. After the expiration or manual termination of drying and removal of the [sterile material](#), you can immediately re-load the device and start a program.

Duration of the operating pause

Duration of the operating pause	Measure
Short pauses between two sterilization processes	<ul style="list-style-type: none"> Keep the door closed to save energy
Pauses which last longer than an hour	<ul style="list-style-type: none"> Switch off the device
Longer pauses, e.g. overnight or at the weekend	<ul style="list-style-type: none"> Leave the door ajar to prevent premature wear and the sticking of the door gasket Switch off the device.
Longer than two weeks	<p>Before starting the operating pause:</p> <ul style="list-style-type: none"> Leave the door ajar to prevent premature wear and the sticking of the door gasket Switch off the device Empty and close the wastewater and feed water containers <p>Following the operating pause:</p> <ul style="list-style-type: none"> Perform a vacuum test After a successful vacuum test, perform an empty sterilization in a sterilization program

Decommissioning

When decommissioning the device for a long pause (e.g. due to holiday or planned transport), proceed as follows:

1. Switch off the device at the power switch.
2. Disconnect the power plug from the socket.
3. Remove the outlet hose from the wastewater container.
4. Empty, clean and close the wastewater container.
5. Remove the feed water hose with the plug from the feed water container. Dry the ends of the hose with a cloth if necessary.
6. Close the feed water container.

Transport

Symbols on the packaging



Indicates the temperature limits to which the device can be safely exposed.



Denotes a device that may break or be damaged if handled carelessly.



Indicates a device that must be protected against moisture.



Indicates the upper limit of humidity to which the device can be safely exposed.

On-site transport

To transport the device within a room or floor, proceed as follows:

1. Remove the trays from sterilization chamber.
2. Close the device door.
3. Switch off the device at the power switch.
4. Disconnect the power plug from the socket.
5. Remove the hoses from the rear of the device.
6. Remove the outlet hose from the wastewater container.
7. Empty, clean and close the wastewater container.
8. Remove the feed water hose with the plug from the feed water container. Dry the ends of the hose with a cloth if necessary.
9. Close the feed water container.

Off-site transport

To transport the device over longer distances, to different floors or for shipping, proceed as follows:

1. Prepare the device for transport in accordance with [On-site transport](#) [▶ page 76].
2. Pack the device so that it is protected from mechanical hazards (e.g. blows) and moisture.
3. Observe the transport and storage conditions, see [Technical data](#) [▶ page 82].

Recommissioning after relocation



When recommissioning after changing the location of the device, proceed as for initial commissioning, see [Setup and installation](#) [▶ page 22].

14 Malfunctions

Comply with the following for safe handling:

- Should the device issue the same malfunction message repeatedly, turn off the device and if necessary, inform your stockist.
- The device may only be serviced by ► [authorised technicians](#).

Not all notifications on the display are malfunction messages. Warning and malfunction messages are issued on the display with an event number. This number serves identification purposes.

Type of message		Description
	Warning	A warning message helps to ensure malfunction-free operation and recognition of undesirable events. React to warning messages quickly to prevent the resulting malfunction.
	Malfunction messages	A malfunction message is issued when it is not possible to ensure safe operation or safety of sterilization. These can appear on the display shortly after switching on the device or during a program run. If a malfunction occurs during a program run, the program will be aborted and considered unsuccessful.



Troubleshooting online

All messages with current descriptions can be found in the Troubleshooting portal on the MELAG website (<https://www.melag.com/en/service/troubleshooting>).



Displaying and reading messages

If there are several messages, the number is shown in the corresponding button in the header.

1. Press  or  to maximise the view of the existing message or to open the message list if there are several messages.

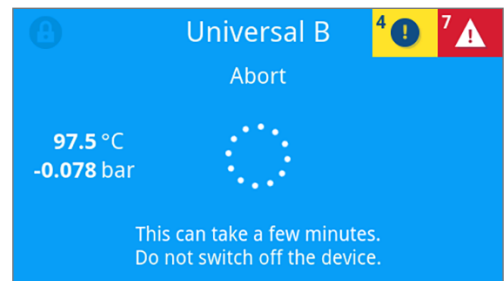

2. Press  in the message list to display the corresponding message.

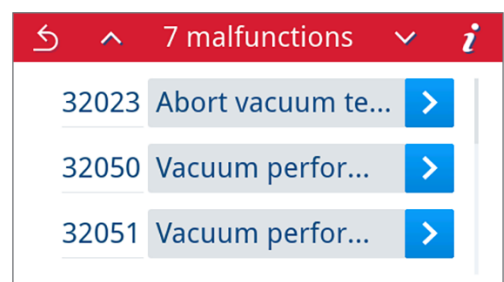

3. The maximised message can be minimised with  or acknowledged by confirming with **OK**.

Acknowledged messages cannot be displayed again.

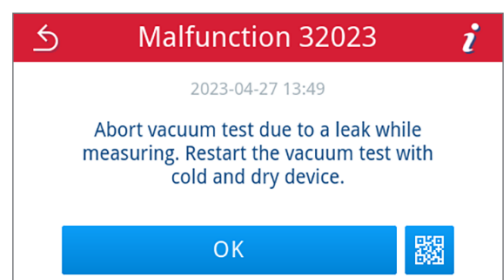

Before contacting customer services

Follow the instructions that appear on the display in connection with a message.

The following tables indicate possible causes for certain messages/events and the corresponding operating information for their remedy. Should you be unable to find the relevant event, or your efforts do not redress the problem, you can contact your nearest stockist or authorised MELAG customer service provider. Have the following information ready:

- The serial number of your device (see type plate or device status info)
- the event number and/or
- a detailed description of the message.

Malfunction logs

In the **Logs > Malfunctions** menu, you can view malfunction logs and output them to a USB flash drive, see [Subsequent log output](#) [▶ page 44].

Warning and malfunction messages

Event	Possible cause	What you can do
30201	The safety LED is defective.	Please contact technical service.
30660 32410 37415	Water of insufficient quality e.g. tap water was used.	Please empty and clean the feed water container and fill it with water of the appropriate quality (EN 13060), see Feed water quality [▶ page 85].
32002 32024 32050 32051 37014	a) The surrounding temperature of the steam sterilizer is too hot. The steam sterilizer is installed or the minimum clearances to the surrounding surfaces have not been maintained. b) The steam sterilizer is overloaded or the load has been arranged badly. c) There is packaging residue or other objects in front of the pressure release fittings / vacuum fittings in the chamber.	a) Please ensure sufficient ventilation of the device. Observe the setup conditions. Conversion cabinets are not recommended. b) Please check the load for compliance with the permissible loading quantities. c) Please check if the pressure release fitting / vacuum fitting in the sterilization chamber is covered by packaging residue or other objects and remove them.
32003 32004	a) The device was switched off at the power switch during a program run. b) The power plug has been disconnected or has not been connected correctly in the socket. c) Power failure in the building supply or the RCD on-site has been triggered.	a) Never switch off the device at the power switch during a program run. c) Check whether the power plug is connected, the power cable has suffered damage or a loose contact or loose plug connections is the cause. Plug the power plug back into the mains socket. Make sure that the plug is held in place on the device side by the safety bracket. c) Have the on-site installation checked (e.g. circuit breakers). Test the device in another socket or on another circuit.
32020	a) The sterile filter is blocked. b) The sterile filter is soiled.	Open the door of the device and check whether: a) the sterile filter is blocked or b) heavily soiled. In these cases, replace the sterile filter, see Replacing the sterile filter [▶ page 73].
32021 32022 32023	a) The device is too warm. Residual moisture evaporates and leads to falsification of the result. b) The door gasket is damaged. c) The door gasket is dirty.	a) Please allow the device to cool down. b) Please check the door gasket for visible defects. c) Please clean the door gasket with a damp cloth.

Event	Possible cause	What you can do
32025 32060 32061 32062 32064 32065	There is not enough feed water in the feed water container and/or the suction filter is not resting on the bottom of the container.	Please check whether there is enough feed water in the feed water container. If necessary, top up the feed water. Please check whether the feed water hose is inserted into the container so far that the suction filter is resting on the bottom of the container.
32041 32049	There is packaging residue or other objects in front of the pressure release fitting in the sterilization chamber.	Please check if the pressure release fitting in the sterilization chamber is covered by packaging residue or other objects and remove them.
32043 32046 32048 32069	The steam sterilizer is overloaded or the load has been arranged badly.	Please check the load for compliance with the permissible loading quantities. If this occurs repeatedly, contact the technical service.
35010	Maintenance interval will expire soon.	Please have the device serviced by an authorised technician .
35020	The dust filter must be replaced soon.	Please replace the dust filter promptly, see Dust filter [▶ page 56].
36260	The serial number was entered incorrectly or an installation container for a different device type was used.	Please correct the serial number entry or use an installation container compatible with the device.
36270 36280	An incompatible installation container was used.	Use a compatible installation container. If necessary, please contact technical service.
36283	A defective installation container was used.	Download the installation container to your computer again and then copy the container file to the USB stick. If necessary, please contact technical service.
36285	An obsolete installation container was used.	Please use an installation container with a current version. If necessary, contact the technical service.
36300 36420	More than one USB flash drive has been inserted.	The device supports only one USB flash drive at a time. Please remove all USB flash drives except one.
36410	USB stick was not recognised.	Check whether the USB stick has been formatted as FAT32 file system and, if necessary, use another USB stick.
36421	More than one printer has been connected via USB.	Remove all printers except one.
36415 36425	USB stick is not inserted or not inserted correctly.	Insert a USB stick or check that the USB stick is inserted correctly.
36435	a) The USB flash drive was removed during the writing process. b) The USB flash drive is not connected correctly.	a) Please re-insert the USB flash drive. b) Please check whether the USB flash drive is inserted correctly.
36501 36502	a) The print job was cancelled. b) The printer is not configured correctly.	a) Restart the printer. First start the device and then the printer. b) Check and, if necessary, correct the printer configuration.
36506	A log printer is configured but not connected.	a) Connect the log printer via the interface on the rear of the device. b) Restart the printer. First start the device and then the printer.
36512	a) The paper roll of the printer is used up. b) An incorrect roll was inserted.	a) Please load a new paper roll into the printer. b) Please load the correct roll into the printer.
36522	The log printer cover is open while a print job was being sent.	Please close the log printer cover.

Event	Possible cause	What you can do
36535	The printer connected to the USB port does not support log printing.	Use a suitable printer such as the MELAprint 80 universal printer.
36560	a) The network cable has been pulled out or is damaged. b) The network cable is not compatible. c) The computer is not switched on. d) The network connection has not been configured correctly. e) The documentation software on the computer has not been started.	a) Check whether the network cable is correctly connected or damaged. b) Check whether a 1:1 network cable is connected. A 1:1 cable must be used for the direct connection between the device and the computer. c) Switch on the computer. d) Check the network settings, see Network [▶ page 65]. e) Start the documentation software.
36710	The maximum number of program logs not output was reached. The oldest log will be overwritten the next time the program is run.	Please output the internally stored logs to a USB flash drive or to your practice network. The log output can also be done automatically; this must be configured in the Log output [▶ page 57] menu.
36720	The USB stick does not have enough free space to store the required log data.	Save the data on the USB stick in the practice network, and then delete them from the USB stick to free up space for new logs. Alternatively, use a different USB stick with sufficient memory.
36760	MELAtrace is not connected.	Check the configuration in the settings, see Log output with MELAtrace [▶ page 60].
37013	A program was interrupted.	Please open the door carefully. Steam and hot condensate may be escaping.
37510	An attempt was made to open the door while the device is still pressurised.	Please wait until the pressure compensation is completed.

Manual door emergency-opening

⚠ CAUTION

Warning of scalding

On opening the door, steam and hot water can escape from the sterilization chamber. e.g. if it is necessary to open the door immediately after the end of a program. This could result in scalding.

- Should steam be issued from the rear of the device after its deactivation, wait until the procedure has finished. Wait a further 5 min before opening the door.
- Stand to one side of the door and maintain sufficient distance.
- Allow the sterilization chamber to cool before removing the load.

The door can be opened manually via the emergency opening following a power failure or malfunction.

The following must be fulfilled or present:

- ✓ The device is switched off and has cooled down completely.
- ✓ The power cable is disconnected from the device.

1. Remove the closure plug at the back of the device, e.g. using the tool supplied for manual emergency door opening.



- Using the tool supplied for manual emergency door opening, gently pull the ring out as far as it will go and open the door carefully at the same time.

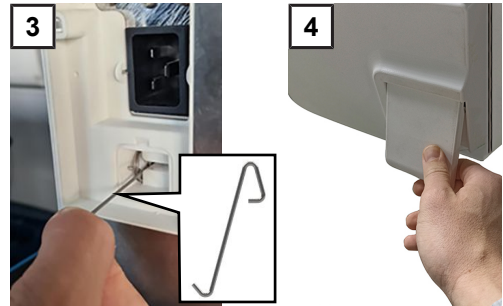

- Push the ring back into its original position.
- Replace the closure plug.

15 Technical data

Device type	Vacuclave 105
Device dimensions (H x W x D)	30 x 30 x 59 cm
Empty weight	27.5 kg
Operating weight	28 kg
Floor loading (normal operation)	1.87 kN/m ²
Floor loading (pressure resistance test)	2.18 kN/m ²
Pressure vessel	
permitted working pressure (relative)	2.7 bar
permitted working temperature	140°C
Sterilization chamber	
Dimensions (H x W x D)	80 x 203 x 310 mm
Volume	5 l
Electrical connection	
Power supply	200-230 V, 50/60 Hz
Max. voltage range	180-253 V
Electrical power	2100 W
Building fuse	separate power circuit min. 10 A, RCD with rated residual current = 30 mA
Overvoltage category	transient overvoltages up to the values of overvoltage category II
Air pollution degree (in accordance with EN 61010-1)	Category 2
Length of the power cable	2 m
Ambient conditions	
Installation location	interior of a building (dry and protected from dust)
Noise emission	55.4 dB(A)
Waste heat (with max. load)	3240 kJ
Ambient temperature	5-40 °C (ideal range 16-26 °C)
Relative humidity	max. 80 % at temperatures of up to 31 °C, max. 50 % at 40 °C (decreasing in linear fashion in-between)
Degree of protection (in accordance with IEC 60529)	IP20
Transport and storage conditions	Temperature: -18 to +50 °C, air humidity: < 80 %
Max. altitude	3000 m
Air pressure	> 690 mbar at 3000 m
Feed water	
Water temperature	5-35 °C
Water quality	distilled or demineralised feed water in accordance with EN 13060
Recommended flow pressure ³⁾	1.5-4.0 bar at 1 l/min
Min. water pressure (static) ⁴⁾	2 bar
Max. water pressure (static) ⁴⁾	6 bar
Max. water consumption per cycle ⁴⁾	approx. 0.3 l
Water volume (initial commissioning)	approx. 0.5 l
Wastewater	
Max. water temperature	short-term 100 °C

³⁾ Optional when using a water treatment unit.

⁴⁾ In the Prion-B program with porous full load.

16 Components, accessories and spare parts

All specified articles are available through specialist dealers.

Components

Category	Article	Art. no.
Trays	Tray, narrow, flat	ME23446
	Tray, narrow, deep	ME23447

Accessory

Category	Article	Art. no.
Films	MELAfol+ (roll, 5 cm x 200 m)	ME00530
	MELAfol+ (roll, 7.5 cm x 200 m)	ME00531
	MELAfol+ (roll, 10 cm x 200 m)	ME00532
	MELAfol+ (roll, 15 cm x 200 m)	ME00533
	MELAfol+ (pouch, 5 cm x 25 cm, 1000 pcs.)	ME00536
	MELAfol+ (pouch, 7.5 cm x 25 cm, 1000 pcs.)	ME00537
	MELAfol+ (pouch, 10 cm x 25 cm, 1000 pcs.)	ME00538
MELAstore System	MELAstore Box Compact	ME83304

Other equipment

Category	Article	Art. no.
Documentation	MELAG USB stick	ME19901
	MELAprint 80 universal printer	ME01108
	Network cable, 2.5 m	ME15817
	Network cable, 5 m	ME15814
	Network cable, 10 m	ME15815
Water treatment	MELAdem 40 ion exchanger	ME01049
	Holder for wall mounting (2 pcs.)	ME15856
Other	Water connection set	ME09046
	Wastewater connection for U-trap	ME09045
	Water stop (leakage water detector with shut-off valve and probe)	ME01056
	Tray lifter	ME28888
	Chamber Protect chamber cleaning set	ME01081
	MELAG Care Oil Spray	ME22935
	Silicone mat MELAstore Box Compact	ME83301
Test body system	MELAcontrol Helix ^{*)}	ME01082
	SteriHero Helix	ME01084
	MELAcontrol type 5 indicator (250 pcs.)	ME01077
	MELAcontrol Bowie & Dick test	ME01078

^{*)} not in combination with MELAstore Box Compact

Spare parts

Article	Art. no.
Sterile filter	ME22872
Dust filter	ME82260
Wastewater container, 5 l (inkl. outlet hose)	ME23524
Outlet hose (8/6 mm, red)	ME86522

Article	Art. no.
Feed water connection (incl. feed water hose, suction filter and plug for feed water container)	ME23526
PUR hose (black) 6/4 mm (10 m) (feed water hose)	ME28820
Door gasket	ME22914
Power cable C19 type E+F	ME22331
Power cable C19 type O (Thailand)	ME22332
Power cable C19 NEMA 6/20 (Taiwan)	ME22333
Power cable C19 type I (GB2099-1/GB1002) (China)	ME22336
Power cable C19 type G (United Kingdom)	ME22337
Power cable C19 type K (Denmark)	ME22338
Power cable C19 type H (Israel)	ME22339
Power cable C19 type I 10A (AS3112) (Australia)	ME22400

17 Technical tables

Feed water quality

Minimum requirements for the quality of the feed water in accordance with EN 13060

Substance/property	Feed water
Evaporation residue	≤ 10 mg/l
Silicon oxide, SiO ₂	≤ 1 mg/l
Iron	≤ 0.2 mg/l
Cadmium	≤ 0.005 mg/l
Lead	≤ 0.05 mg/l
Traces of heavy metal apart from iron, cadmium, lead	≤ 0.1 mg/l
Chloride	≤ 2 mg/l
Phosphate	≤ 0.5 mg/l
pH value	5 - 7.5
Appearance	≤ colourless, clear, without sediments
Hardness	≤ 0.02 mmol/l

Nominal value tolerances

Step	Universal B		Prion B	Gentle B	Quick S	Program phase
	P [mbar _a]	Tolerance	P [mbar _a]			
SP-S	1010		--	--	--	Programm start
SF12	325	30/-30	◀	◀	◀	Evacuation (Fractionation 1)
SF13	1500	100/-20	◀	◀	◀	Pressure build-up (Fractionation 1)
SF21	1050	20/-50	◀	◀	◀	Flow-off (Fractionation 2)
SF22	300	30/-30	◀	◀	400	Evacuation (Fractionation 2)
SF23	1500	100/-20	◀	◀	2050	Pressure build-up (Fractionation 2)
SF31	1050	20/-50	◀	◀	--	Flow-off (Fractionation 3)
SF32	325	30/-30	◀	◀	--	Evacuation (Fractionation 3)
SF33	1500	100/-20	◀	◀	--	Pressure build-up (Fractionation 3)
SF41	1055	20/-50	◀	◀	--	Flow-off (Fractionation 4)
SF42	600	30/-30	◀	◀	--	Evacuation (Fractionation 4)
SF43	2050	100/-20	◀	1100	--	Pressure build-up (Fractionation 4)
SH11	2750	60/-60	◀	1400	◀	Pressure build-up Supply
SH12	2970	60/-60	◀	2042	◀	Pressure build-up Plateau
SS11	3030	60/-60	◀	2062	◀	Preparation Sterilization

Step	Universal B		Prion B	Gentle B	Quick S	Program phase
	P [mbar _a]	Tolerance	P [mbar _a]			
SS12	3140	60/-60	◀	2140	◀	Sterilization
SA12	1055	60/-60	◀	◀	◀	Pressure release
SA13	1000	60/-60	◀	◀	◀	Cooling pressure release

Key:

P = Pressure

T = Tolerance

◀ As in Universal B program

Empty chamber test

The coldest point in the sterilization chamber during the empty chamber test lies directly on the temperature sensor on the chamber rear wall (see circle marking in the following figure). The temperature in the rest of the sterilization chamber is almost the same all over.

Schematic side and fore view of the sterilization chamber



Pressure-time chart

Pressure-time diagram for Universal B, 134 °C and 2.1 bar

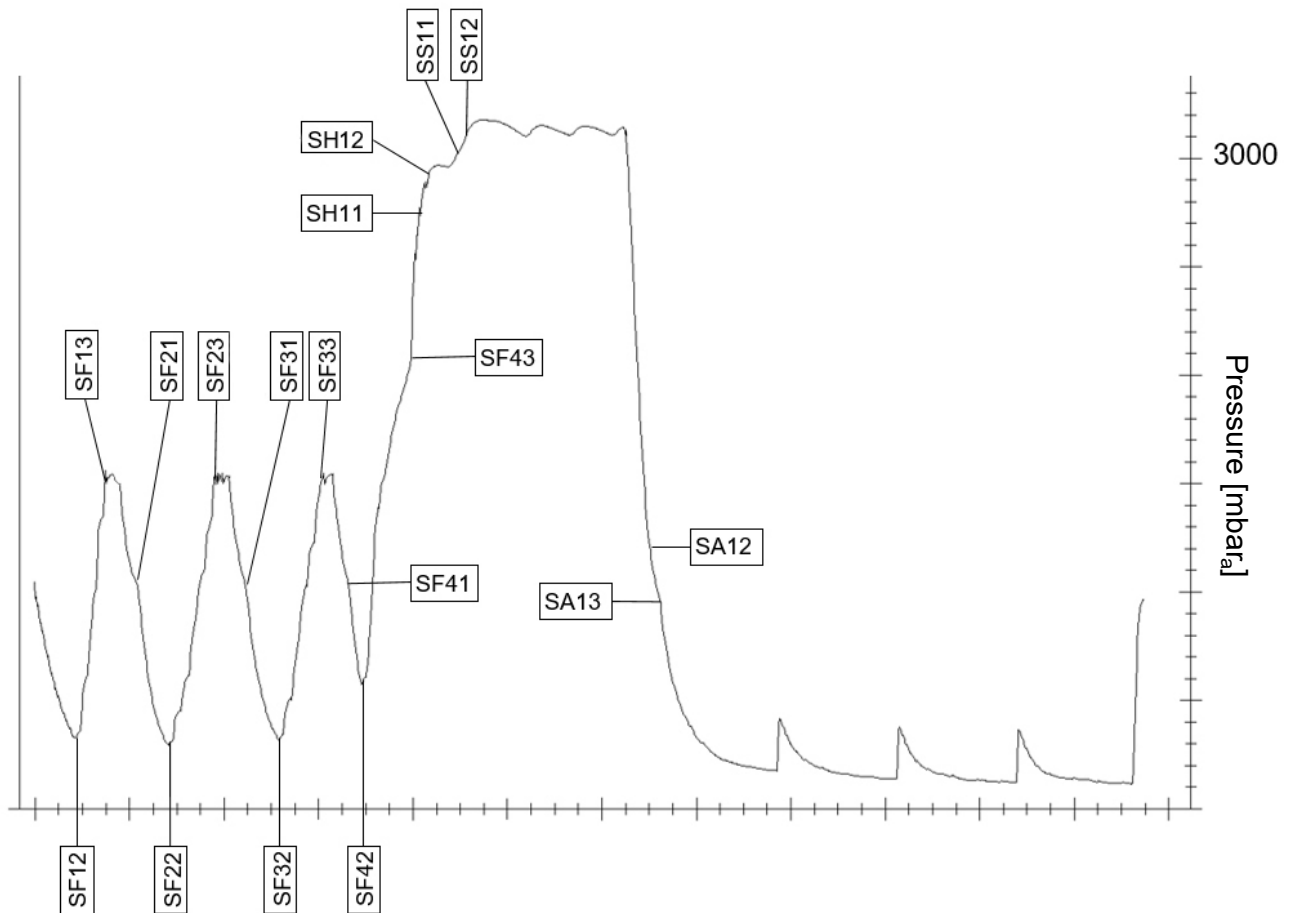

Pressure-time diagram for Prion B, 134 °C and 2.1 bar

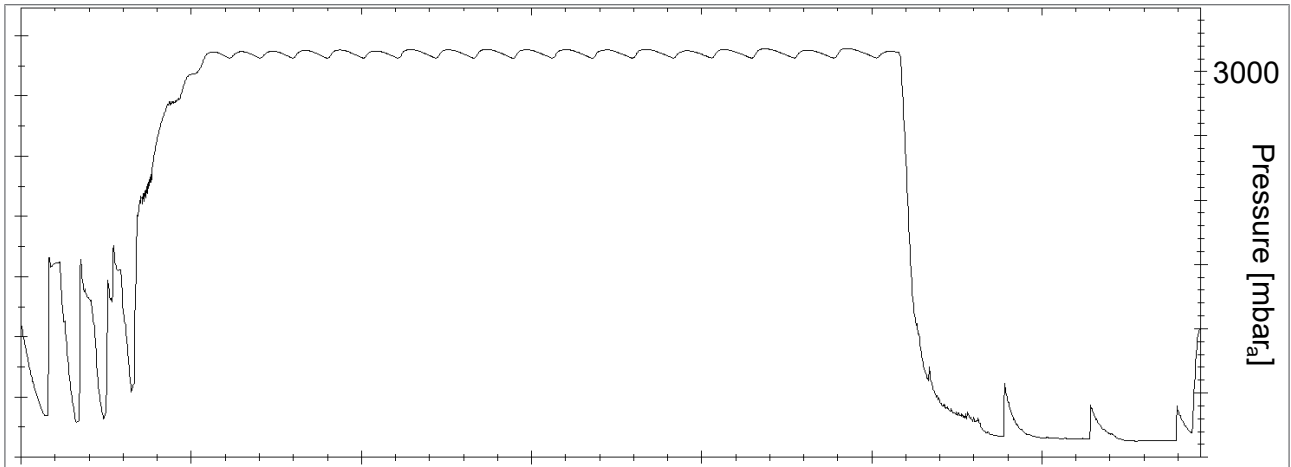

Pressure-time diagram for Gentle B, 121 °C and 1.2 bar

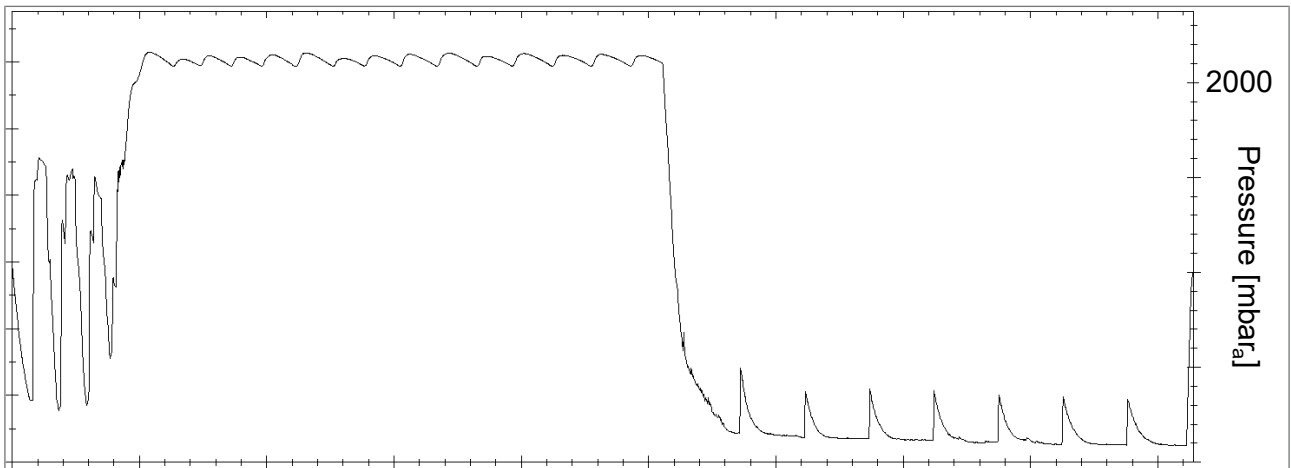

Pressure-time diagram for Quick S, 134 °C and 2.1 bar

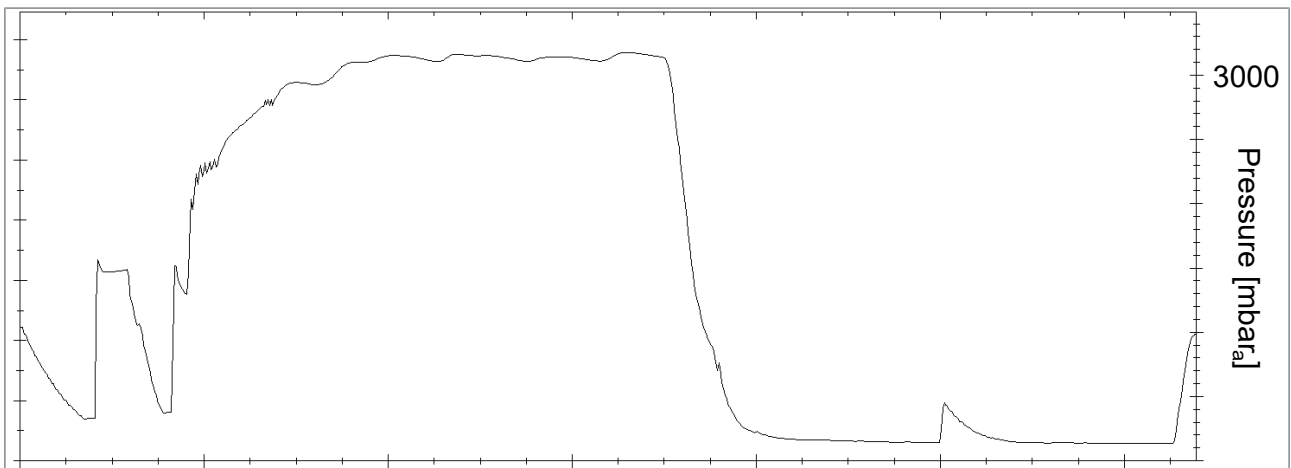

Glossary

Accessory

Accessories are independent articles that are used with one or several medical devices. Accessories specifically and directly assist the intended purpose of the medical device.

Air leakage

An air leakage is a location through which air can pass in or out without this being desired. The verification of the leakage serves to prove that the volume of air ingress in the sterilization chamber during the vacuum phase does not exceed a value which would prevent steam penetration of the load and that the air leakage does not cause the possible contamination of the load during the drying phase.

AKI

AKI is the abbreviation for "Arbeitskreis Instrumentenaufbereitung" [Instrument Reprocessing Working Group].

Authorised technician

An authorised technician is a person intensively trained and authorised by MELAG who has sufficient specific device and technical knowledge to perform maintenance and installation work on MELAG devices. Only they may carry out this work.

Batch

The batch is the composition of items which has been subject to the same reprocessing procedure.

BfArM

BfArM is the abbreviation for "Bundesinstitut für Arzneimittel und Medizinprodukte" [Federal Institute for Drugs and Medical Devices] in Germany.

Competent personnel

Trained personnel in accordance with national specifications for the respective area of application (dentistry, medicine, podiatry, veterinary medicine, cosmetics, piercing, tattoo) with the following contents: knowledge of instruments, hygiene and microbiology, risk assessment and classification of medical devices and instrument reprocessing.

Component

A component is a part of a medical device, which is delivered with it but is not permanently connected to it. A component supports or achieves the intended purpose of the medical device for at least one use case. It is not an independent accessory or medical device.

Condensate

Condensate is a liquid (e.g. water) that emerges from the vapour state when cooled and thus separates.

Conductivity

Conductivity is the ability of a conductive chemical substance or mixture of substances to conduct or transfer energy or other substances or particles in space.

Corrosion

Corrosion is the chemical alteration or destruction of metallic materials by water and chemical substances.

Delay in boiling

Superheating is the phenomenon that it is possible under certain circumstances to heat liquids beyond their boiling point without them boiling. This condition is unstable. Low-level agitation can produce a large bubble within the shortest period; this can expand explosively.

Demineralised water

Demineralised water does not contain minerals that are found in normal spring or tap water. It is obtained from tap water by ion exchange and used as feed water.

DGSV

DGSV is the abbreviation for "Deutsche Gesellschaft für Sterilgutversorgung" [German Society for Sterile Supply]. The training guidelines of the DGSV are listed in DIN 58946, Part 6 as requirements for personnel.

DGUV Regulation 1

DGUV is the abbreviation for "Deutsche Gesetzliche Unfallversicherung" [German Statutory Accident Insurance]. The regulation 1 governs the principles of prevention.

DIN 58946-7

Standard for "Sterilization – Steam sterilizers – Part 7: Building requirements and requirements placed on the equipment and the operation of steam sterilizers in the health-care branch"

DIN 58953

Standard for "Sterilization – Sterile supply"

Distilled water

Distilled water is largely free of salts, organic substances, and micro-organisms. It is obtained by distillation (evaporation and subsequent condensation) from normal tap water or pre-purified water. Distilled water is used as feed water.

Dynamic pressure test

The dynamic pressure test serves to prove that the rate of pressure variations in the sterilization chamber during a sterilization cycle does not exceed a particular value which could result in the damage of the packaging material, see EN 13060.

Empty chamber test

The empty chamber test is a test without a load and is performed to assess the performance of the steam sterilizer without the influence of a load. This allows the temperatures and pressures obtained to be checked against the intended settings, see EN 13060.

EN 13060

Standard for "Small steam sterilizers"

EN 868-8

Standard for "Packaging for medical devices to be sterilized in the final packaging – Part 8: Reusable sterilization containers for steam sterilizers to EN 285 - requirements and test methods"

EN ISO 11140-1

Standard for "sterilization of products for use in medical treatment – chemical indicators – part 1: General requirements"

EN ISO 11607-1

Standard for "packaging for medical devices to be sterilized in the final packaging – Part 1: Requirements placed on materials, sterile barrier systems, and packaging systems"

Equipment

Equipment is an article that can be used with the medical device, however, it is not necessary for assisting and/or achieving the intended purpose of the medical device. It is not an independent accessory or medical device.

Feed water

Feed water is required to generate the water vapour for sterilization; guide values for water quality in accordance with EN 285 or EN 13060 – Appendix C.

Feed water

Feed water is required to generate the water vapour for sterilization; guide values for water quality in accordance with EN 285 or EN 13060.

IEC 61326-1

Standard for "Electrical equipment for measurement, control and laboratory use - EMC requirements - Part 1: General requirements"

KRINKO

KRINKO is the abbreviation for "Kommission für Krankenhaushygiene und Infektionsprävention" [Commission for Hospital Hygiene and Infection Prevention] at the Robert Koch Institute in Germany.

Load

The load includes products, equipment, or materials that are reprocessed together in one operating cycle.

Medical device

Medical device means any instrument, apparatus, appliance, software, implant, reagent, material or other article intended by the manufacturer to be used, alone or in combination, for human beings for one or more of the specific medical purposes in accordance with Regulation (EU) 2017/745 Article 1, Paragraph 4.

Mixed loads

The load within a batch includes both packed and unpacked products.

Multiple wrapping

The load is sealed in a double layer of film, instruments wrapped in foil are additionally planed in a container or containers wrapped in textiles.

pH Value

The pH value is a measure of the strength of the acid or alkali effect of a watery solution.

Plateau period**Porous full load**

The porous full load specification serves to prove that the values set at the control satisfy the necessary sterilization conditions in porous loads with the maximum density for whose sterilization a steam sterilizer is designed to EN 13060.

Porous partial load

The porous partial load specification serves to prove that the values set on the control allow steam to enter the pre-determined test package quickly and equally, see EN 13060.

Process evaluation system

The process evaluation system (also known as "self-monitoring system") monitors itself and compares sensors during running programs.

Product with narrow lumen

A product with narrow lumen is either open on one side or on both sides. The following applies for an article open on one side: $1 \leq L/D \leq 750$ and $L \leq 1500$ mm. The following applies for an article open on both sides: $2 \leq L/D \leq 1500$ and $L \leq 3000$ mm and which does not correspond to the hollow body B (L = hollow body length, D = hollow body diameter), see EN 13060.

Qualified electrician

The qualified electrician has the suitable technical training, knowledge, and experience to recognise and avoid hazards that can be caused by electricity, see IEC 60050 or for Germany VDE 0105-100.

Reprocessing

Reprocessing is a measure to prepare a new or used healthcare device for its intended purpose. Reprocessing includes cleaning, disinfection, sterilization and similar procedures.

RKI

RKI is the abbreviation for "Robert Koch-Institut" [Robert Koch Institute]. The Robert Koch Institute is the central institution for the detection, prevention, and control of diseases, especially infectious diseases.

Simple hollow bodies

A simple hollow body is either open on one side or both sides, see EN 13060. The following applies for an article open on one side: $1 \leq L/D \leq 5$ and $D \geq 5$ mm. The following applies for an article open on both sides: $2 \leq L/D \leq 10$ and $D \geq 5$ (L = hollow body length, D = hollow body diameter).

Single wrapping

The load is wrapped once in a sterile barrier system (e.g. transparent sterilization package). The opposite of this is multiple wrapping.

Soft sterilization packaging

A soft sterilization wrapping is a paper bag or a transparent sterilization package.

Solid

Solid describes the property of a product that is made of non-porous material that has no bulges or other design features that offer greater or equal resistance to steam penetration than a simple hollow body.

Solid load

The solid load specification serves to prove that the necessary sterilization conditions have been reached within the entire load with the values set in the control. The load must represent the largest weight of solid instruments for whose sterilization a steam sterilizer is designed to EN 13060.

Sterile barrier system

The sterile barrier system is a minimum level of sealed packaging that prevents the entry of micro-organisms (e.g. sealed pouches, sealed reusable containers, folded sterilization wipes) and allows for the aseptic delivery of the product at the point of use.

Sterile material

Sterile goods are successfully sterilized (i.e. sterile) goods. Sterile goods are also referred to as batches.

Sterilization chamber

The sterilization chamber is the part of the steam sterilizer where the load is sterilized.

Vacuum

Colloquially, vacuum is a space free of matter. In the technical sense, it is a volume with reduced gas pressure (mostly air pressure).

Certificate of Suitability

According to the recommendations of the Commission for Hospital Hygiene and Infection Prevention at the Robert Koch Institute

Manufacturer:	MELAG Medizintechnik GmbH & Co. KG
Address:	Geneststr. 6-10 10829 Berlin
Country:	Germany
Product:	Vacuclave® 105
Type of device:	Steam sterilizer
Classification:	Class IIa
Device type acc. to EN 13060:	Type B

We declare that the product specified above is suitable for the steam sterilization of

- **Solid instruments (wrapped and unwrapped)**
- **Porous goods (wrapped and unwrapped)**
- **Instruments with narrow lumen (wrapped and unwrapped)**
- **Simple hollow bodies (wrapped and unwrapped)**

References to loading quantities and loading variations are outlined in the user manual and must be observed.

Be sure to observe the manufacturer's instructions for medical devices intended for sterilization according to EN ISO 17664-1.

We declare that the following test system is suited for testing the product specified above:

- **MELAcontrol® Helix**
- **SteriHero® Helix**

Berlin, 01.03.2026

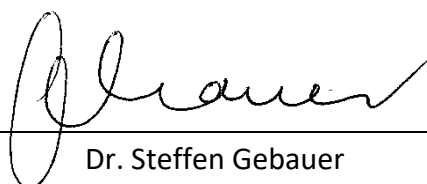

Dr. Steffen Gebauer
(Management)



MELAG Medizintechnik GmbH & Co. KG

Geneststr. 6-10

D-10829 Berlin

Germany

Email: info@melag.com

Web: www.melag.com

Original instructions

Responsible for content: MELAG Medizintechnik GmbH & Co. KG

We reserve the right to technical alterations