

BOSS™

KSV Ball Valves

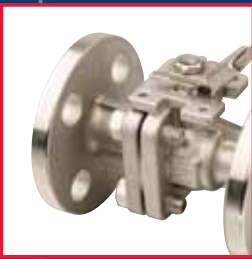

Full Bore Antistatic Ball Valve 3 pce Non-Firesafe 1000WOG

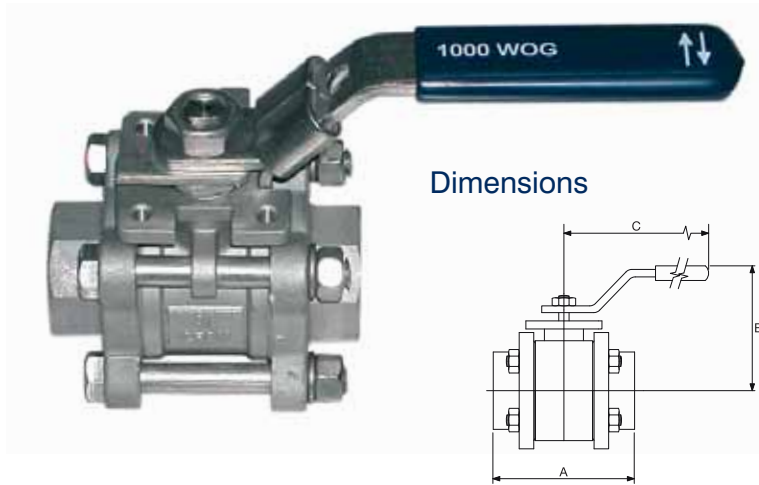

Operation under pressure (differential pressure) – Torque Test

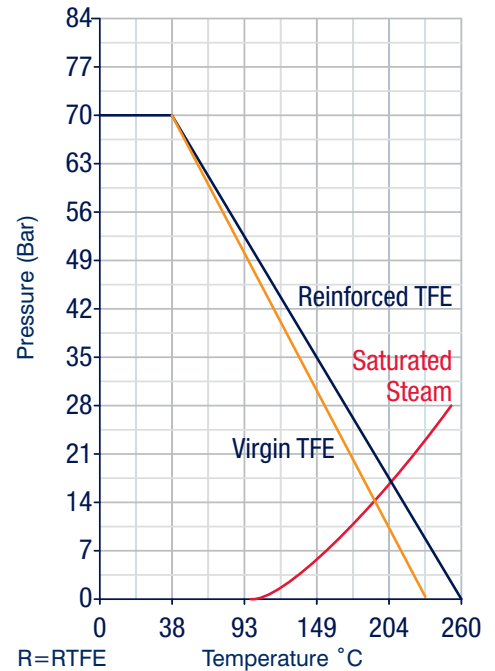
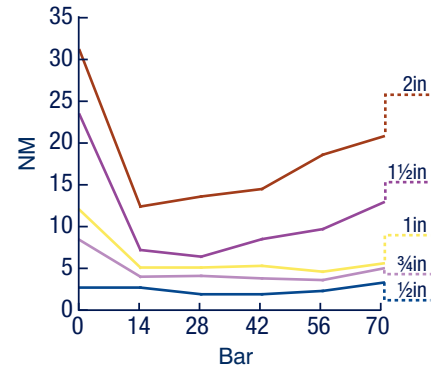

Materials of Construction

| | |
|------------------|------------------------------------|
| Body | A216 WCB or A351 CF8M |
| Stem | A276 316SS |
| Body cap | A216 WCB or A351 CF8M |
| Ball | Stainless Steel A351 CF8M |
| Seat | 15% Glass filled PTFE |
| Stem seal | 15% Glass filled PTFE |
| Body seals | Virgin PTFE |
| Thrust seals | 35% Graphite or Carbon filled PTFE |
| Gland packing | Graphite |
| Ident label | Stainless Steel |
| Spring & plunger | Stainless Steel |

| Size in mm | Operation under pressure (differential pressure) – Torque Test | | | | | | | Dimensions | | | BSPT ends | SW ends |
|---------------|--|--------|--------|--------|--------|--------|---------|------------|---------|-----------------|-----------------|---------|
| | 0 Bar | 14 Bar | 28 Bar | 41 Bar | 55 Bar | 69 Bar | A mm | B mm | C mm | Product Code | Product Code | |
| ½ 15 | 2.7 | 2.7 | 1.9 | 1.9 | 2.3 | 3.3 | 70.2 | 60 | 106 | 30900011 | 30900140 | |
| ¾ 20 | 8.4 | 4.0 | 4.1 | 3.8 | 3.6 | 5.0 | 77 | 72 | 128 | 30900022 | 30900151 | |
| 1 25 | 12.0 | 5.1 | 5.1 | 5.3 | 4.6 | 5.6 | 92 | 78 | 128 | 30900033 | 30900162 | |
| 1½ 40 | 23.4 | 7.2 | 6.4 | 8.5 | 9.7 | 12.9 | 120 | 93 | 199 | 30900044 | 30900173 | |
| 2 50 | 31.1 | 12.4 | 13.6 | 14.5 | 18.6 | 20.8 | 138 | 104 | 199 | 30900055 | 30900184 | |

Other seat options & end connections available on request

The products supplied by BSS are generally in accordance with British or other International Standard specifications where applicable and as interpreted by the manufacturers, and present no hazard to health or safety if and when properly installed and operated. There are however, many occasions when goods are ordered from us without any reference being made to their intended use. In such cases, the Company must assume that the user will take all necessary steps to ensure that the products purchased are suitable for the conditions in which they are intended to operate.

This guide generally indicates the Standards and Classes with which the products comply, but if in doubt, please consult your nearest BSS branch. Care has been taken to ensure that the information in this guide is accurate but any illustrations and brief descriptions are intended to provide an approximate guide only and are not subject to contractual liability. To the best of our knowledge, the data contained herein is accurate at the time of publication.

The BSS Group plc and its subsidiary companies assume no responsibility for typographical errors or omissions or for any misinterpretation of the information provided in this guide. All design are subject to alteration without notice.

Full Bore Antistatic Ball Valve 3pce Firesafe Class 800

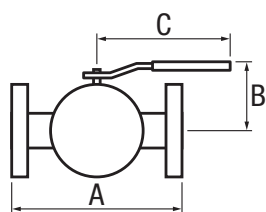

Dimension key only

Operation under pressure (differential pressure) – Torque Test

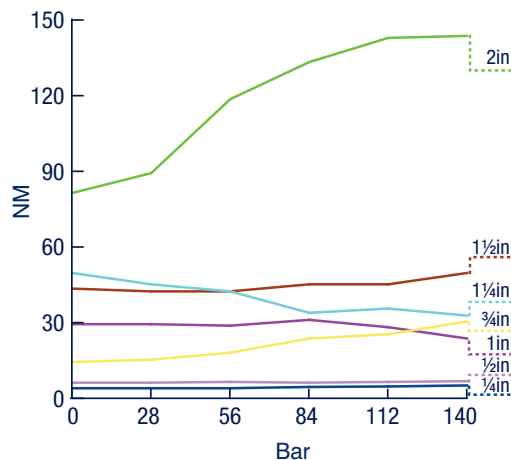

Firesafe certified: API 607

Materials of Construction

| | |
|----------------------|---------------------------|
| Body | A216 WCB or A351-CF8M |
| Anti-static stem | A276 316SS |
| Body cap | A216 WCB or A351-CF8M |
| Ball | Stainless Steel A351-CF8M |
| Seat | TFE/RTFE |
| Stem seal | TFE/RTFE |
| Union seals | Graphite |
| Stem packing | Graphite |
| Identification label | Stainless Steel |
| Spring & plunger | Stainless Steel |

| Size in mm | Operation under pressure (differential pressure) – Torque Test | | | | | | Dimensions | | | BSPT ends | SW ends |
|---------------|--|--------|--------|--------|---------|---------|------------|---------|---------|--------------|--------------|
| | 0 Bar | 28 Bar | 55 Bar | 83 Bar | 110 Bar | 138 Bar | A mm | B mm | C mm | Product Code | Product Code |
| 1/4 15 | 4.0 | 4.0 | 4.0 | 4.5 | 4.7 | 5.1 | 66.0 | 62.3 | 110 | N/A | N/A |
| 3/8 15 | 4.0 | 4.0 | 4.0 | 4.5 | 4.7 | 5.1 | 66.0 | 62.3 | 110 | N/A | N/A |
| 1/2 15 | 6.2 | 6.2 | 6.2 | 6.5 | 6.5 | 6.8 | 69.6 | 66.3 | 110 | 30901485 | 30901496 |
| 3/4 20 | 14.4 | 15.3 | 18.1 | 23.7 | 25.4 | 30.5 | 81.0 | 76.5 | 143 | 30901504 | 30901515 |
| 1 25 | 29.4 | 29.4 | 28.8 | 31.1 | 28.2 | 23.7 | 95.0 | 85.2 | 145 | 30901526 | 30901537 |
| 1 1/4 32 | 49.7 | 45.2 | 42.4 | 33.9 | 35.6 | 32.8 | 108.2 | 92.5 | 190 | 30901548 | 30901559 |
| 1 1/2 40 | 43.5 | 42.4 | 42.4 | 45.2 | 45.2 | 49.7 | 120.0 | 98.5 | 190 | 30901570 | 30901581 |
| 2 50 | 81.4 | 89.3 | 118.6 | 133.3 | 142.9 | 143.7 | 143.0 | 134.4 | 295 | 30901592 | 30901600 |

Other seat options & end connections available on request

Reduced Bore Ball Valve 1 pce Firesafe Class 150

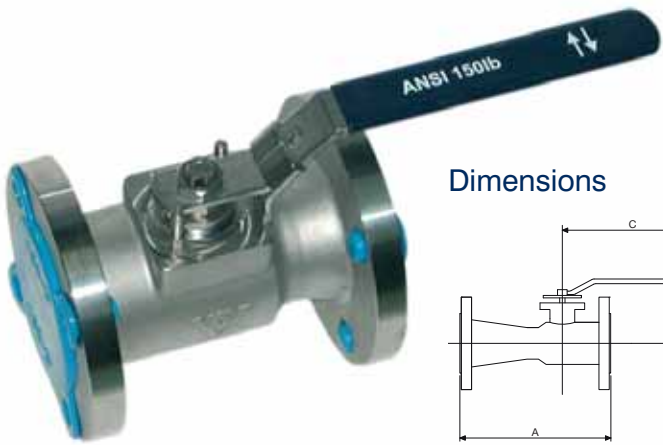

Dimensions

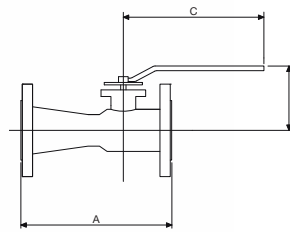

Firesafe certified: API 607

Materials of Construction

| | |
|----------------|--|
| Body | A216 WCB or A351CF8M |
| Body cap | A216 WCB or A351CF8M |
| Stem | A276 316SS |
| Ball | Stainless Steel A351CF8M |
| Seat | 15% Glass Filled PTFE |
| Stem seal | PTFE |
| Body seals | Virgin PTFE |
| Thrust seals | 15% Glass Filled PTFE |
| Gland packing | Flexible Graphite with Corrosion Inhibitor |
| Ident label | Stainless Steel |
| Spring plunger | Stainless Steel |

Operation under pressure (differential pressure) – Torque Test

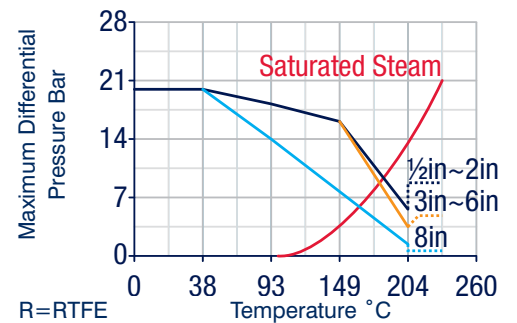
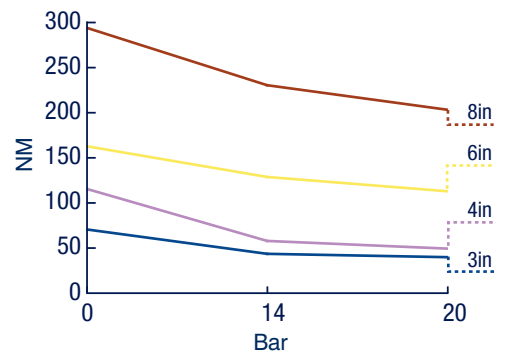
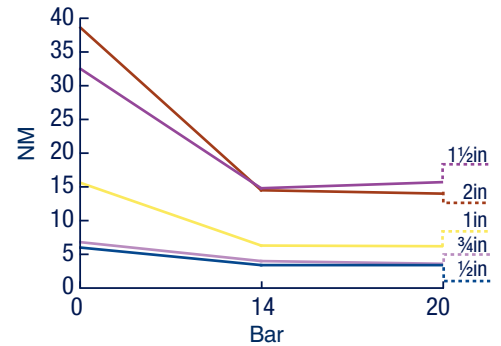

| Size | Operation under pressure (differential pressure) – Torque Test | | | Dimensions | | | Stainless steel | Carbon steel |
|----------|--|--------|--------|------------|-------|------|-----------------|--------------|
| | 0 Bar | 14 Bar | 20 Bar | A | B | C | Product Code | Product Code |
| 1/2 in | 6.0 | 3.4 | 3.4 | 108 | 65 | 154 | 30900066 | 30902347 |
| 3/4 in | 6.8 | 4.0 | 3.6 | 117 | 68.5 | 154 | 30900077 | 30902358 |
| 1 in | 15.6 | 6.3 | 6.2 | 127 | 82.96 | 171 | 30900088 | 30902369 |
| 1 1/2 in | 32.5 | 14.8 | 15.7 | 165 | 101.4 | 250 | 30900099 | 30902380 |
| 2 in | 38.6 | 14.5 | 14.0 | 178 | 107.4 | 250 | 30900107 | 30902391 |
| 3 in | 70.5 | 43.6 | 39.9 | 203 | 150.7 | 400 | 30900118 | 30902410 |
| 4 in | 115.3 | 57.9 | 49.4 | 229 | 163.2 | 400 | 30900129 | 30902421 |
| 6 in | 162.7 | 128.8 | 113.0 | 267 | 166.7 | 609 | 30901057 | 30902432 |
| 8 in | 293.8 | 230.5 | 203.4 | 292 | 261.5 | 1000 | 30901205 | 30902443 |

Other seat options available on request

Carbon & Stainless Steel Ball Valves **BOSS™**

Full Bore Antistatic Ball Valve 2pce Firesafe Class 150

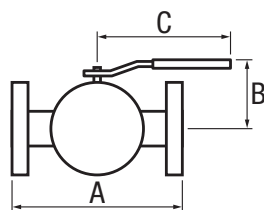

Dimension key only

Firesafe certified: API 607

Materials of Construction

| | |
|------------------|---------------------------|
| Body | A216 WCB or A351 CF8M |
| Anti-static stem | A276 316SS |
| Body cap | A216 WCB or A351 CF8M |
| Ball | Stainless Steel A351 CF8M |
| Seat | TFE/RTFE |
| Stem seal | TFE/RTFE |
| Stem packing | Graphite |
| Body seal | SS304+Graphite |
| Ident label | Stainless Steel |
| Spring & plunger | Stainless Steel |

Operation under pressure (differential pressure) – Torque Test

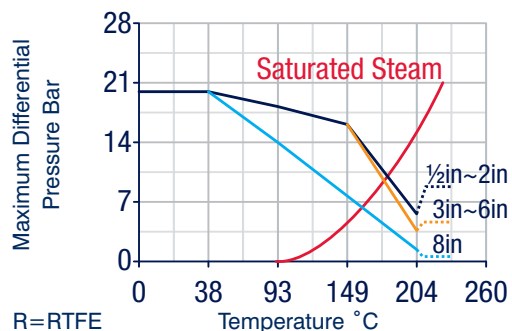
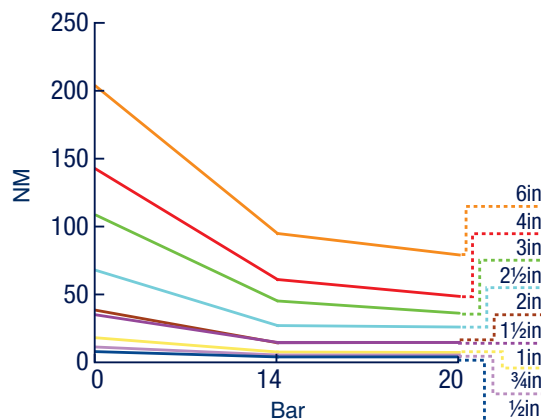

R=RTFE

| Size in mm | Operation under pressure (differential pressure) – Torque Test | | | Dimensions | | | Stainless steel | Carbon steel |
|---------------|---|--------|--------|------------|---------|---------|-----------------|--------------|
| | 0 Bar | 14 Bar | 20 Bar | A mm | B mm | C mm | Product Code | Product Code |
| 1/2 15 | 7.9 | 4.0 | 4.0 | 108 | 67 | 131 | 30901216 | 30902454 |
| 3/4 20 | 11.3 | 5.4 | 5.4 | 117 | 80 | 178 | 30901249 | 30902487 |
| 1 25 | 18.1 | 7.6 | 7.3 | 127 | 85 | 198 | 30901282 | 30902517 |
| 1 1/2 40 | 35.0 | 14.7 | 14.7 | 165 | 114 | 255 | 30901312 | 30902550 |
| 2 50 | 38.4 | 14.4 | 14.7 | 178 | 122 | 255 | 30901345 | 30902583 |
| 2 1/2 65 | 67.8 | 27.1 | 26.0 | 190.5 | 163 | 400 | N/A | 30902613 |
| 3 80 | 108.5 | 45.2 | 36.2 | 203 | 171 | 400 | 30901378 | 30902635 |
| 4 100 | 142.4 | 61.0 | 48.6 | 229 | 202 | 460 | 30901419 | 30902668 |
| 6 150 | 203.4 | 94.9 | 79.1 | 393.7 | 270 | 610 | 30901452 | 30902709 |

Other seat options available on request

Full Bore Antistatic Ball Valve 2pce Firesafe Class 300

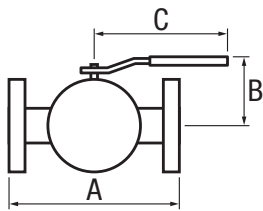
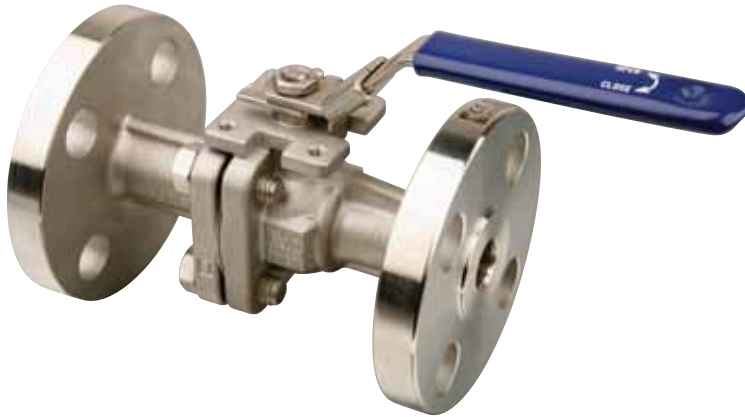

Dimension key only

Firesafe certified: API 607

Materials of Construction

| | |
|------------------|---------------------------|
| Body | A216 WCB or A351 CF8M |
| Anti-Static Stem | A276 316SS |
| Body cap | A216 WCB or A351 CF8M |
| Ball | Stainless Steel A351 CF8M |
| Seat | TFE/RTFE |
| Stem seal | TFE/RTFE |
| Stem packing | Graphite |
| Body seal | SS304+Graphite |
| Ident label | Stainless Steel |
| Spring & plunger | Stainless Steel |

Operation under pressure (differential pressure) – Torque Test

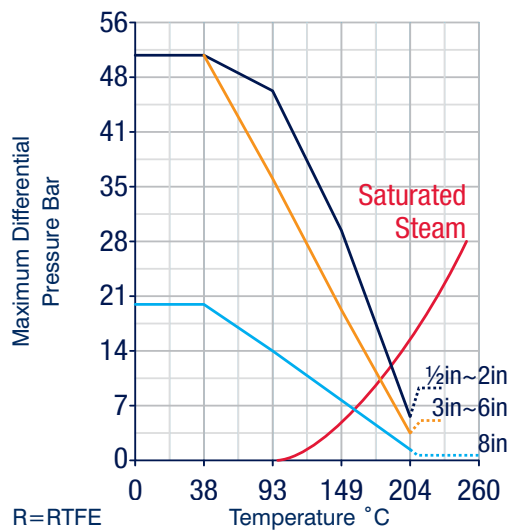
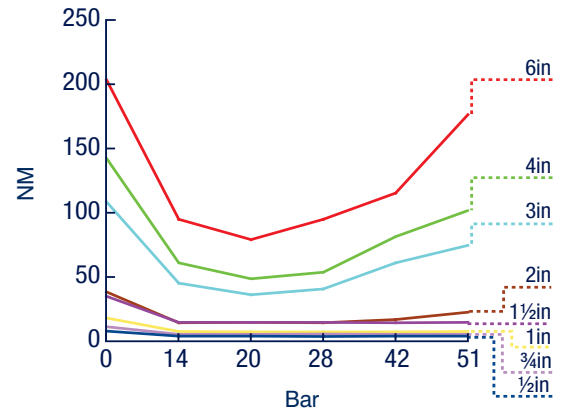

R=RTFE

| Size | | Operation under pressure (differential pressure) – Torque Test | | | | | | Dimensions | | | Stainless Steel | Carbon Steel |
|-------|-----|--|--------|--------|--------|--------|--------|------------|------|-----|-----------------|--------------|
| in | mm | 0 Bar | 14 Bar | 20 Bar | 28 Bar | 41 Bar | 51 Bar | A | B | C | Product Code | Product Code |
| 1/2 | 15 | 7.9 | 4.0 | 4.0 | 3.7 | 4.0 | 4.0 | 139.7 | 75.5 | 131 | 30901227 | 30902465 |
| 3/4 | 20 | 11.3 | 5.4 | 5.4 | 5.6 | 5.4 | 5.4 | 152.4 | 76.5 | 178 | 30901260 | 30902498 |
| 1 | 25 | 18.1 | 7.6 | 7.3 | 7.3 | 7.3 | 7.6 | 165 | 85 | 198 | 30901293 | 30902528 |
| 1 1/2 | 40 | 35.0 | 14.7 | 14.7 | 14.7 | 14.4 | 14.7 | 190 | 114 | 255 | 30901323 | 30902561 |
| 2 | 50 | 38.4 | 14.4 | 14.7 | 14.4 | 16.9 | 22.6 | 216 | 122 | 255 | 30901356 | 30902594 |
| 3 | 80 | 108.5 | 45.2 | 36.2 | 40.7 | 61.0 | 74.6 | 282.5 | 171 | 400 | 30901389 | 30902646 |
| 4 | 100 | 142.4 | 61.0 | 48.6 | 53.7 | 81.4 | 101.7 | 304.8 | 202 | 460 | 30901430 | 30902679 |
| 6 | 150 | 203.4 | 94.9 | 79.1 | 94.9 | 115.3 | 176.3 | 403.35 | 270 | 610 | 30901463 | 30902720 |

Other seat options available on request

Carbon & Stainless Steel Ball Valves **BOSS™**

Full Bore Antistatic Ball Valve 2pce Firesafe PN16

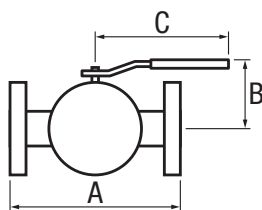

Dimension key only

Firesafe certified: API 607

Materials of Construction

| | |
|------------------|---------------------------|
| Body | EN-1.0619 or EN-1.4408 |
| Anti-static stem | A276 316SS |
| Body cap | EN-1.0619 or EN-1.4408 |
| Ball | Stainless Steel A351-CF8M |
| Seat | TFE/RTFE |
| Stem seal | TFE/RTFE |
| Union seals | 304SS+Graphite |
| Stem packing | Graphite |
| Ident label | Stainless Steel |
| Spring & plunger | Stainless Steel |

Operation under pressure (differential pressure) – Torque Test

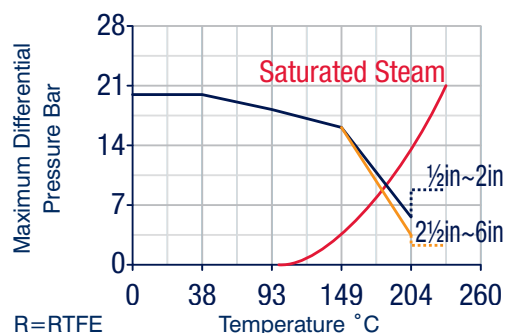
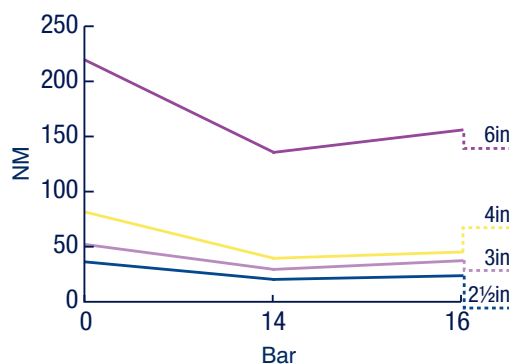
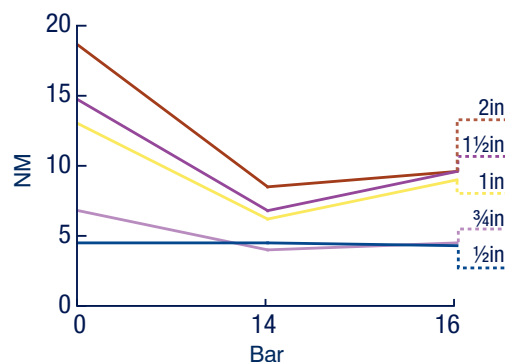

| Size in mm | Operation under pressure (differential pressure) – Torque Test | | | Dimensions | | | Stainless steel | Carbon steel |
|---------------|---|--------|--------|------------|---------|---------|-----------------|--------------|
| | 0 Bar | 14 Bar | 16 Bar | A mm | B mm | C mm | Product Code | Product Code |
| 1/2 15 | 4.5 | 4.5 | 4.3 | 111 | 70.5 | 131.4 | 30901238 | 30902476 |
| 3/4 20 | 6.8 | 4.0 | 4.5 | 116 | 77 | 177 | 30901271 | 30902506 |
| 1 25 | 13.0 | 6.2 | 9.0 | 121 | 87.8 | 197 | 30901301 | 30902539 |
| 1 1/2 40 | 14.7 | 6.8 | 9.6 | 140 | 117.4 | 250 | 30901334 | 30902572 |
| 2 50 | 18.6 | 8.5 | 9.6 | 150 | 130.17 | 250 | 30901367 | 30902602 |
| 2 1/2 65 | 36.2 | 20.3 | 23.7 | 170 | 163.05 | 405 | N/A | 30902624 |
| 3 80 | 52.0 | 29.4 | 37.3 | 180 | 171.55 | 405 | 30901408 | 30902657 |
| 4 100 | 81.4 | 39.5 | 45.2 | 190 | 199.15 | 460 | 30901441 | 30902690 |
| 6 150 | 219.2 | 135.6 | 155.9 | 350 | 255.85 | 610 | 30901474 | 30902731 |

Other seat options available on request



Pipeline & Heating Solutions

BSS BRANCH LOCATIONS THROUGHOUT THE UK & IRELAND

ABERDEEN Unit 5, South Middleton Base, Greenwell Road, East Tullos, Aberdeen AB12 3AX
Tel: 01224 292929 Fax: 01224 898252
Email: 1550.sales@bssgroup.com

BELFAST 36-38 Duncrue Road, Duncrue Industrial Estate, Belfast, Northern Ireland BT3 9BP
Tel: 028 9078 4000 Fax: 021 552 5363
Email: 1910.sales@bssgroup.com

BIRMINGHAM Units 2 & 4 Crystal Drive, Sandwell Business Park, Smethwick, Warley, West Midlands B66 1QG
Tel: 0121 552 6000 Fax: 0121 552 5363
Email: 1220.sales@bssgroup.com

BIRMINGHAM CENTRAL Unit 49, Gravelly Industrial Park, Tyburn Road, Erdington, Birmingham B24 8TG
Tel: 0121 322 0370 Fax: 0121 322 2296
Email: 1810.sales@bssgroup.com

BOREHAMWOOD Chester Road, Borehamwood, Herts WD6 1LT
Tel: 020 8327 4100 Fax: 020 8327 4101
Email: 1500.sales@bssgroup.com

BOURNEMOUTH Unit 3B, Broom Road Business Park, Broom Road, Poole, Dorset BH12 4PA
Tel: 01202 711300 Fax: 01202 711301
Email: 1400.sales@bssgroup.com

BRENTFORD Transport Avenue, Great West Road, Brentford, Middlesex TW8 9HF
Tel: 020 8232 2727 Fax: 020 8232 2730
Email: 1110.sales@bssgroup.com

BRISTOL Albert Road, St Phillips, Bristol BS2 0BS
Tel: 0117 972 7900 Fax: 0117 972 7901
Email: 1250.sales@bssgroup.com

CAMBRIDGE Unit 3, Rosemary Lane, Cambridge CB1 3LQ
Tel: 01223 404040 Fax: 01223 240420
Email: 1840.sales@bssgroup.com

CARDIFF Unit 4, Trident Park, Glass Avenue, Ocean Way, Cardiff CF24 5EN
Tel: 029 2043 2400 Fax: 029 2049 7815
Email: 1280.sales@bssgroup.com

CARLISLE Unit 2A, Port Road Business Park, Carlisle CA2 7AJ
Tel: 01228 517600 Fax: 01228 598090
Email: 1780.sales@bssgroup.com

CHESSINGTON Oakcroft Road, Chessington Industrial Estate, Chessington, Surrey KT9 1RH
Tel: 020 8974 3800 Fax: 020 8391 5241
Email: 1950.sales@bssgroup.com

COLCHESTER Unit 6, Smeaton Close, Severalls Industrial Park, Colchester, Essex CO4 9QY
Tel: 01206 754720 Fax: 01206 752649
Email: 1200.sales@bssgroup.com

CORK Unit 20, South Link Park, Ballycurren Road, Grange, Cork
Tel: 00353 214 321588 Fax: 00353 214 321595
Email: 1960.sales@bssgroup.com

COVENTRY Unit 17, Torrington Avenue, Coventry, West Midlands CV4 9HN
Tel: 024 7669 4744 Fax: 024 7647 0574
Email: 1490.sales@bssgroup.com

CRAWLEY 12A Denvale Trade Park, Haslett Avenue East, Crawley RH10 1SS
Tel: 01293 610170 Fax: 01293 523388
Email: 1390.sales@bssgroup.com

CROYDON Unit 34, Factory Lane, Croydon, Surrey CR0 3RL
Tel: 020 8662 2300 Fax: 020 8681 6142
Email: 1120.sales@bssgroup.com

DARTFORD Unit 11 Orbital One, Green Street, Green Road, Dartford, Kent DA1 1QG
Tel: 01322 289039 Fax: 01322 289149
Email: 1570.sales@bssgroup.com

DERBY Riverside Road, Pride Park, Derby DE24 8HH
Tel: 01332 685600 Fax: 01332 685601
Email: 1450.sales@bssgroup.com

DUBLIN White Heather Industrial Estate, 301 South Circular Road, Dublin 8
Tel: 00353 14 165100 Fax: 00353 14 165165
Email: 1930.sales@bssgroup.com

DUNDEE Unit 1-3, Rutherford Road, Dryburgh Industrial Estate, Dundee DD2 3XH
Tel: 01382 823700 Fax: 01382 826921
Email: 1580.sales@bssgroup.com

EDINBURGH Unit 2A, Pentland Industrial Estate, Loanhead, Midlothian, Edinburgh EH20 9QH
Tel: 0131 440 5900 Fax: 0131 440 3761
Email: 1560.sales@bssgroup.com

EXETER Unit 6, Otter Court, Manaton Close, Matford Business Park, Exeter EX2 8PF
Tel: 01392 457500 Fax: 01392 425976
Email: 1240.sales@bssgroup.com

GLASGOW Unit A, Vermont Street, Kinning Park, Glasgow G41 1LU
Tel: 0141 418 4444 Fax: 0141 429 2638
Email: 1540.sales@bssgroup.com

GLOUCESTER Unit C1, Eastbrook Road Trading Estate, Eastern Avenue, Gloucester, GL4 3DB
Tel: 01452 872200 Fax: 01452 309899
Email: 1230.sales@bssgroup.com

GRIMSBY Europa Park, Gilbey Road, Grimsby DN31 2FD
Tel: 01472 265100 Fax: 01472 241638
Email: 1680.sales@bssgroup.com

HULL Copenhagen Road, Sutton Fields Industrial Estate, Hull, East Yorkshire HU7 0YH
Tel: 01482 625800 Fax: 01482 838870
Email: 1610.sales@bssgroup.com

KINGS CROSS Unit 2, 1 Brewery Road, Islington, London N7 9QJ
Tel: 020 7619 7600 Fax: 020 7700 2482
Email: 1160.sales@bssgroup.com

LEEDS Turnkey Park Estate, Whitehall Road, Leeds LS12 6AD
Tel: 0113 203 2203 Fax: 0113 279 8662
Email: 1350.sales@bssgroup.com

LEICESTER 66 Cobden Street, Leicester LE1 2LB
Tel: 0116 242 7800 Fax: 0116 253 2456
Email: 1440.sales@bssgroup.com

LEWES Unit 5, South Downs Business Park, Brooks Road, Lewes, East Sussex BN7 2FB
Tel: 01273 485000 Fax: 01273 480709
Email: 1190.sales@bssgroup.com

LINCOLN Units 3/4, Crofton Drive, Allenby Industrial Estate, Lincoln LN3 4NR
Tel: 01522 565700 Fax: 01522 512678
Email: 1480.sales@bssgroup.com

LIVERPOOL 82/94 Great Howard Street, Liverpool L3 7AX
Tel: 0151 482 2500 Fax: 0151 207 2317
Email: 1330.sales@bssgroup.com

LONDON DOCKLANDS Units 6 & 7, Thomas Road Industrial Estate, Limehouse, London E14 7BN
Tel: 020 7531 3900 Fax: 020 7537 4849
Email: 1920.sales@bssgroup.com

LUTON 1 Trojan Court, Laporte Way, Luton, Beds LU4 8RJ
Tel: 01582 875600 Fax: 01582 452050
Email: 1420.sales@bssgroup.com

MAIDSTONE Unit 5, Wood Close, Quarry Wood Industrial Estate, Aylesford, Kent ME20 7UB
Tel: 01622 713600 Fax: 01622 713616
Email: 1850.sales@bssgroup.com

MANCHESTER Unit 1, Columbus Way, Off Broadway, Salford, Manchester M50 1UU
Tel: 0161 888 6464 Fax: 0161 888 6465
Email: 1340.sales@bssgroup.com

NEWCASTLE Sanderson Street, Newcastle-upon-Tyne NE4 7PJ
Tel: 0191 256 5100 Fax: 0191 272 3115
Email: 1650.sales@bssgroup.com

NORTHAMPTON Riverside Way, Bedford Road, Northampton NN1 5NX
Tel: 01604 251400 Fax: 01604 620588
Email: 1410.sales@bssgroup.com

NORWICH Unit 13, Alston Road, Hellesdon Park Industrial Estate, Norwich, Norfolk NR6 5DS
Tel: 01603 253200 Fax: 01603 418839
Email: 1710.sales@bssgroup.com

NOTTINGHAM Unit 3, Longwall Avenue, Queens Drive Industrial Estate, Nottingham NG2 1NA
Tel: 0115 943 5900 Fax: 0115 986 1099
Email: 1430.sales@bssgroup.com

OXFORD Unit C Taurus, Peterley Road, Horspath Industrial Estate, Cowley, Oxford OX4 2TZ
Tel: 01865 398870 Fax: 01865 777552
Email: 1630.sales@bssgroup.com

PETERBOROUGH Unit 2a, Centurion Business Centre, Sturrock Way, Bretton, Peterborough PE3 8YB
Tel: 01733 336000 Fax: 01733 265790
Email: 1470.sales@bssgroup.com

PLYMOUTH Block G, St. Modwen Road, Parkway Industrial Estate, Plymouth, Devon PL6 8LH
Tel: 01752 675300 Fax: 01752 220063
Email: 1260.sales@bssgroup.com

PORTSMOUTH Unit D4 Discovery, Voyager Park, Portfield Road, Airport Industrial Estate, Hilsa, Portsmouth PO3 5FL
Tel: 02392 658740 Fax: 02392 669922
Email: 1820.sales@bssgroup.com

PRESTON Unit 1 & 2, Brookfield Street, Preston PR1 1NR
Tel: 01772 557800 Fax: 01772 259285
Email: 1310.sales@bssgroup.com

READING Units A2 & A3, Worton Drive, Worton Grange Industrial Estate, Reading, Berks RG2 0TG
Tel: 0118 923 8900 Fax: 0118 975 0497
Email: 1180.sales@bssgroup.com

ROMFORD King George Close, Eastern Avenue West, Romford, Essex RM7 7PS
Tel: 01708 771800 Fax: 01708 723168
Email: 1130.sales@bssgroup.com

SHEFFIELD Unit 15, Oakham Drive, Parkwood Industrial Estate, Sheffield S3 9QX
Tel: 0114 289 3900 Fax: 0114 276 7178
Email: 1460.sales@bssgroup.com

SOUTHAMPTON Unit A1, Parham Drive, Boyatt Wood Trading Estate, Eastleigh, Hampshire SO50 4NU
Tel: 023 8068 3700 Fax: 023 8064 3928
Email: 1140.sales@bssgroup.com

STOCKTON Teesway Industrial Estate, Stockton on Tees, Teesway TS18 2RS
Tel: 01642 665500 Fax: 01642 674652
Email: 1660.sales@bssgroup.com

STOKE ON TRENT Units 6 & 7, Etruria Way, Basford, Stoke on Trent ST4 6JQ
Tel: 01782 382382 Fax: 01782 621456
Email: 1360.sales@bssgroup.com

STRATFORD Unit 7 Stratford Hub, Barbers Road, Stratford, East London E15 2PE
Tel: 020 8534 4005 Fax: 020 8519 9888
Email: 1370.sales@bssgroup.com

SWANSEA Century Park, Valley Way, Swansea Enterprise Park, Swansea SA6 8QP
Tel: 01792 762300 Fax: 01792 775922
Email: 1290.sales@bssgroup.com

SWINDON Unit 4A, Euroway Industrial Estate, Ramsden Road, Swindon SN5 8YW
Tel: 01793 601500 Fax: 01793 512144
Email: 1210.sales@bssgroup.com

WANDSWORTH Unit 5, 307-309 Merton Road, Wandsworth, London, SW18 5JS
Tel: 020 8877 9191 Fax: 020 8877 9719
Email: 1760.sales@bssgroup.com

WIGAN Unit 2, Lockflight Buildings, Wheatlea Industrial Estate, Wheatlea Road, Wigan WN3 6XP
Tel: 01942 405540 Fax: 01942 405541
Email: 1720.sales@bssgroup.com

WIRRAL Rossmore Road East, Rossmore Industrial Estate, Ellesmere Port, South Wirral, Cheshire CH65 3DD
Tel: 0151 348 5400 Fax: 0151 357 2001
Email: 1320.sales@bssgroup.com



The BSS Group plc

Registered Office: The BSS Group plc, Fleet House, Lee Circle, Leicester LE1 3QQ, England. Registered No. 60987 BOSSKSV/0409/5