

Display CARFAX in online listings:



Vehicle History Report™

US \$44.99

2008 BMW M3

VIN: WBSVA93548E215810
SEDAN 4 DR
4.0L V8 F DOHC 32V
GASOLINE
REAR WHEEL DRIVE

This CARFAX Report Provided by:
Broad Arrow Group

Damage reported: minor damage

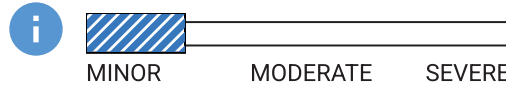

15 Service history records

6 Previous owners

Types of owners: Corporate, Personal

70,822 Last reported odometer reading



This CARFAX Vehicle History Report is based only on information supplied to CARFAX and available as of 10/31/25 at 6:02:17 PM (CDT). Other information about this vehicle, including problems, may not have been reported to CARFAX. Use this report as one important tool, along with a vehicle inspection and test drive, to make a better decision about your next used car.



Accident / Damage History

Not all accidents / issues are reported to CARFAX

Event 1

03/31/2020

Damage reported: minor damage

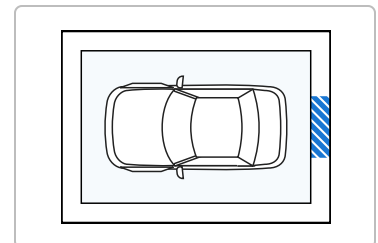
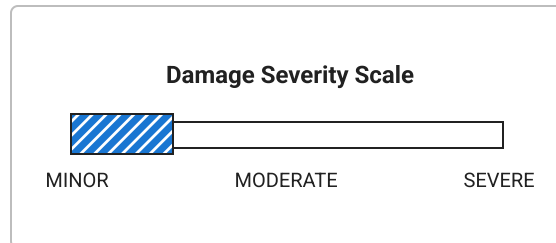



Event 2

06/11/2023

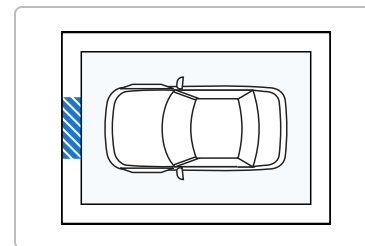
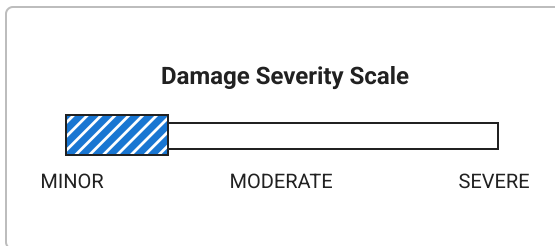
Damage reported: minor damage















 Additional History Not all accidents / issues are reported to CARFAX	Owners 1-4	Owner 5	Owner 6
Total Loss No total loss reported to CARFAX.	<input checked="" type="checkbox"/> No Issues Reported	<input checked="" type="checkbox"/> No Issues Reported	<input checked="" type="checkbox"/> No Issues Reported
Structural Damage CARFAX recommends that you have this vehicle inspected by a collision repair specialist.	<input checked="" type="checkbox"/> No Issues Reported	<input checked="" type="checkbox"/> No Issues Reported	<input checked="" type="checkbox"/> No Issues Reported
Airbag Deployment No airbag deployment reported to CARFAX.	<input checked="" type="checkbox"/> No Issues Reported	<input checked="" type="checkbox"/> No Issues Reported	<input checked="" type="checkbox"/> No Issues Reported
Odometer Check No indication of an odometer rollback.	<input checked="" type="checkbox"/> No Issues Indicated	<input checked="" type="checkbox"/> No Issues Indicated	<input checked="" type="checkbox"/> No Issues Indicated
Accident / Damage Damage reported: 03/31/2020 and 06/11/2023.	Minor Damage	Minor Damage	No New Issues Reported
Manufacturer Recall No open recalls reported to CARFAX.	<input checked="" type="checkbox"/> No Recalls Reported	<input checked="" type="checkbox"/> No Recalls Reported	<input checked="" type="checkbox"/> No Recalls Reported
Basic Warranty Original warranty estimated to have expired.	Warranty Expired	Warranty Expired	Warranty Expired



 Title History CARFAX guarantees the information in this section	Owners 1-4	Owner 5	Owner 6
Damage Brands Salvage Junk Rebuilt Fire Flood Hail Lemon	<input checked="" type="checkbox"/> Guaranteed No Problem	<input checked="" type="checkbox"/> Guaranteed No Problem	<input checked="" type="checkbox"/> Guaranteed No Problem
Odometer Brands Not Actual Mileage Exceeds Mechanical Limits	<input checked="" type="checkbox"/> Guaranteed No Problem	<input checked="" type="checkbox"/> Guaranteed No Problem	<input checked="" type="checkbox"/> Guaranteed No Problem







GUARANTEED - None of these title problems were reported by a U.S. state Department of Motor Vehicles (DMV). If you find that any of these title problems were reported by a DMV and not included in this report, you may qualify. [View Terms](#) | [View Certificate](#)

 Ownership History The number of owners is estimated	Owners 1-4	Owner 5	Owner 6
Year purchased	2009	2022	2024
Type of owner	See Details	Personal	Personal
Estimated length of ownership	13 yrs. 9 mo.	1 yr. 4 mo.	1 yr. 7 mo.
Owned in the following states/provinces	See Details	California	California
Estimated miles driven per year	See Details	10,302/yr	---
Last reported odometer reading	53,223	66,674	70,822







 Detailed History			
 Owner 1 Purchased: 2009		Low mileage! This owner drove less than the industry average of 15,000 miles per year.	Corporate Vehicle 9,900 mi/yr
Date	Mileage	Source	Comments
09/24/2008	10	McKenna BMW Norwalk, CA 562-868-3233 mckennabmw.com  4.5 / 5.0 307 Verified Reviews  685 Customer Favorites	 Vehicle serviced - Pre-delivery inspection completed - Front license plate bracket installed/replaced
10/30/2008		McKenna BMW Norwalk, CA 562-868-3233 mckennabmw.com  4.5 / 5.0 307 Verified Reviews  685 Customer Favorites	 Vehicle serviced - Pre-delivery inspection completed
11/26/2008		McKenna BMW Norwalk, CA 562-868-3233 mckennabmw.com  4.5 / 5.0 307 Verified Reviews  685 Customer Favorites	 Vehicle serviced
01/30/2009	65	California	Odometer reading reported

		Motor Vehicle Dept. Pacific Palisades, CA	- Titled or registered as corporate vehicle
02/12/2009		California Motor Vehicle Dept. Pacific Palisades, CA	Title issued or updated - First owner reported - Loan or lien reported
02/06/2012	29,957	Auto Auction	Listed as a dealer vehicle - Vehicle sold
			Millions of used vehicles are bought and sold at auction every year.
02/11/2012		Dealer Inventory	Vehicle offered for sale
02/15/2012		Overseas Automotive Repair San Diego, CA 858-695-1990	 Vehicle serviced - Emissions inspection performed
02/15/2012	29,964	California Inspection Station San Diego, CA	Passed emissions inspection

 Owner 2 Purchased: 2012		Low mileage! This owner drove less than the industry average of 15,000 miles per year.	Personal Vehicle 2,191 mi/yr
--	--	---	---------------------------------

Date	Mileage	Source	Comments
03/27/2012	29,979	California Motor Vehicle Dept. Santa Barbara, CA	Odometer reading reported
05/22/2012	30,874	Santa Barbara Auto Group Santa Barbara, CA 805-682-2000 sbautogroup.com ★ 4.7 / 5.0 67 Verified Reviews	 Vehicle serviced - Maintenance inspection completed - Tire condition and pressure checked
06/01/2012		California Motor Vehicle Dept. Santa Barbara, CA	Title issued or updated - New owner reported
09/03/2012	33,828	Big Brand Tires Santa Barbara, CA 805-837-6721 ★ 4.7 / 5.0 131 Verified Reviews	 Vehicle serviced

 **85** Customer Favorites

09/24/2012	34,656	Santa Barbara Auto Group Santa Barbara, CA 805-682-2000 sbautogroup.com ★ 4.7 / 5.0 67 Verified Reviews		Vehicle serviced - Maintenance inspection completed - Engine/powertrain computer/module checked - Fuel pressure checked - Tire condition and pressure checked
02/05/2014	42,987	California Inspection Station Santa Barbara, CA		Passed emissions inspection
11/06/2014	43,085	Santa Barbara Auto Group Santa Barbara, CA 805-682-2000 sbautogroup.com ★ 4.7 / 5.0 67 Verified Reviews		Vehicle serviced - Maintenance inspection completed - Battery/charging system checked - Battery replaced - Brake fluid flushed/changed - Fluids checked - Oil and filter changed - Tire condition and pressure checked
06/27/2018	44,087	Santa Barbara Auto Group Santa Barbara, CA 805-682-2000 sbautogroup.com ★ 4.7 / 5.0 67 Verified Reviews		Vehicle serviced - Maintenance inspection completed - Battery replaced - Left airbag assembly replaced - Oil and filter changed - Tire condition and pressure checked
07/25/2018	44,208	California Inspection Station		Passed emissions inspection
07/26/2018		Santa Barbara Auto Group Santa Barbara, CA 805-682-2000 sbautogroup.com ★ 4.7 / 5.0 67 Verified Reviews		Vehicle serviced - Emissions inspection performed - Tire condition and pressure checked
03/19/2020		3M Dealer 651-736-9295 3m.com/ppf		Vehicle serviced
03/31/2020		Damage Report		Damage reported: minor damage - Damage to rear

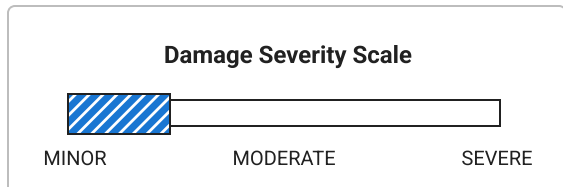

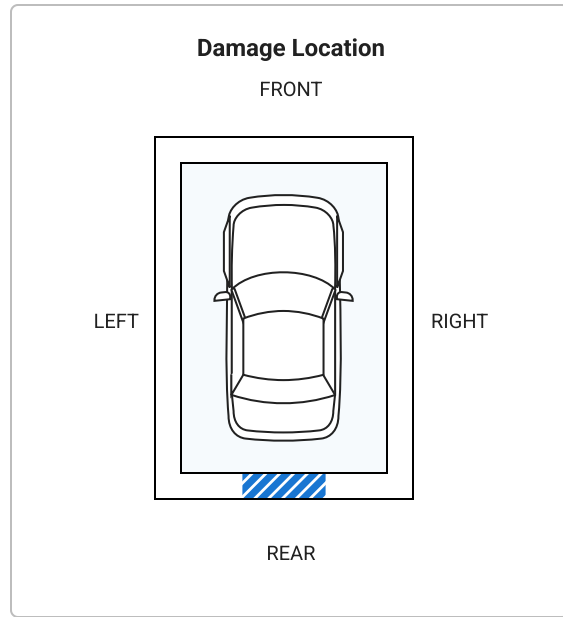

Minor damage is usually cosmetic, including dents or scratches to the vehicle body.

04/22/2020	47,681	California Inspection Station	Passed emissions inspection
04/27/2020		Cornerstone Auto Center Oakland, CA 510-636-0471 ★ 4.8 / 5.0 5 Verified Reviews ♥ 3 Customer Favorites	Vehicle serviced - Emissions inspection performed

Owner 3 Personal Vehicle
 Purchased: 2020

Date	Mileage	Source	Comments
06/05/2020		California Motor Vehicle Dept. Oakland, CA	Title issued or updated - New owner reported
09/04/2020	48,607	AutoNation Toyota Hayward Hayward, CA ★ 4.1 / 5.0 335 Verified Reviews ♥ 352 Customer Favorites	Vehicle offered for sale
09/08/2020	48,699	California Inspection Station	Passed emissions inspection

09/10/2020

AutoNation Toyota
 Hayward
 Hayward, CA
 510-224-4854
 autonation.com



Vehicle serviced

- Pre-delivery inspection completed
- Brakes checked
- Emissions inspection performed
- Oil and filter changed

★ 4.1 / 5.0

335 Verified Reviews

♥ 352 Customer Favorites



Looks like this dealer serviced the car in order to prepare it for sale. That's a good thing!



Owner 4

Purchased: 2020



Low mileage! This owner drove less than the industry average of 15,000 miles per year.

Personal Vehicle
 2,068 mi/yr

Date	Mileage	Source	Comments
09/14/2020	48,717	California Motor Vehicle Dept. Lincoln, CA	Odometer reading reported
10/05/2020		California Motor Vehicle Dept. Lincoln, CA	Title issued or updated - New owner reported - Loan or lien reported
04/18/2022	51,186	California Inspection Station	Passed emissions inspection
10/20/2022		California Motor Vehicle Dept. Lincoln, CA	Title issued or updated - Loan or lien released
11/18/2022	53,223	California Inspection Station	Passed emissions inspection



Owner 5

Purchased: 2022



Low mileage! This owner drove less than the industry average of 15,000 miles per year.

Personal Vehicle
 10,302 mi/yr

Date	Mileage	Source	Comments
11/21/2022		California Motor Vehicle Dept. Rodeo, CA	Title issued or updated - New owner reported
12/19/2022	54,315	Performance Technic, Inc. Fremont, CA	Vehicle serviced - Battery replaced

925-426-1361
performancetechnic.com

★ 4.9 / 5.0

63 Verified Reviews

♥ 51 Customer Favorites

06/11/2023

Damage Report



Damage reported: minor damage
- Damage to front

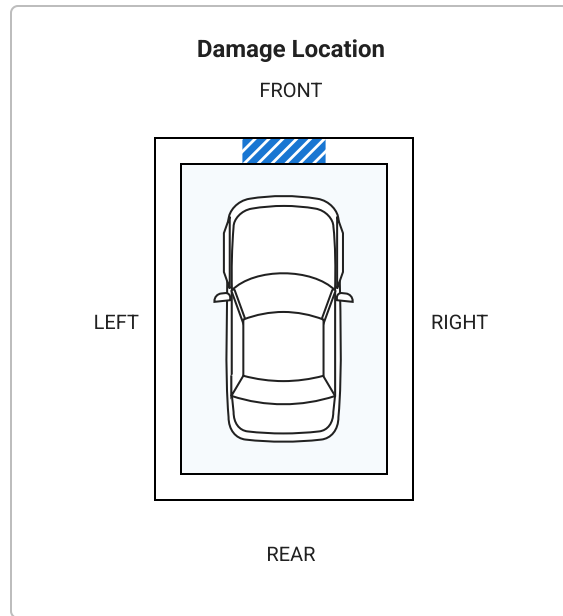
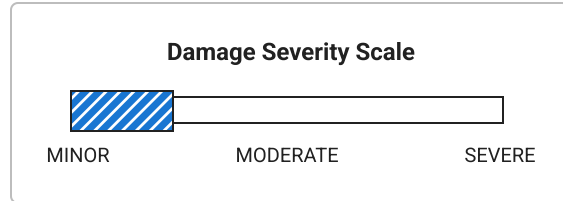

Minor damage is usually cosmetic, including dents or scratches to the vehicle body.

02/29/2024 66,650 California Inspection Station

Passed emissions inspection

02/29/2024 66,674 California Inspection Station

Passed emissions inspection

Owner 6
Purchased: 2024

Personal Vehicle

Date	Mileage	Source	Comments
------	---------	--------	----------

03/29/2024		California Motor Vehicle Dept. Vallejo, CA	Title issued or updated - New owner reported
------------	--	--	--

04/08/2024	67,300	Vallejo Nissan Vallejo, CA 707-643-8291 vallejonissan.com/ ★ 4.3 / 5.0 299 Verified Reviews	 Vehicle serviced - Battery/charging system checked - Tire condition and pressure checked - Vehicle washed/detailed
06/10/2024		California Motor Vehicle Dept. American Canyon, CA	Registration updated when owner moved the vehicle to a new location
03/21/2025	70,822	California Inspection Station	Passed emissions inspection

Have Questions? Consumers, please visit our Help Center at www.carfax.com. Dealers or Subscribers, please visit our Help Center at www.carfaxonline.com.



Glossary

Damage Indicator

Damage can be a result of many different types of events. Examples include contact with objects (other cars, trees, traffic signs, road debris, etc), vandalism, or weather-related events. Not every damage event is reported to CARFAX. As details about the damage event become available, those additional details are added to the CARFAX Vehicle History Report. CARFAX recommends that you have this vehicle inspected by a qualified mechanic.

- This CARFAX Vehicle History Report is based only on information supplied to CARFAX and available as of 10/31/25 at 6:02:17 PM (CDT). Other information about this vehicle, including problems, may not have been reported to CARFAX. Use this report as one important tool, along with a vehicle inspection and test drive, to make a better decision about your next used car.

Damage Severity

Damage events result in one of the following severity levels:

- Minor: Generally, minor damage is cosmetic (including dents or scratches), may only require reconditioning, and typically does not compromise a vehicle's operation and/or safety.
- Moderate: Moderate damage may affect multiple components of the vehicle and may impair the vehicle's operation and/or safety.
- Severe: Severe damage usually affects multiple components of the vehicle and is likely to compromise the vehicle's operation and/or safety.

CARFAX recommends getting a pre-purchase inspection at a certified collision repair facility.

First Owner

When the first owner(s) obtains a title from a Department of Motor Vehicles as proof of ownership.

New Owner Reported

When a vehicle is sold to a new owner, the Title must be transferred to the new owner(s) at a Department of Motor Vehicles.

Ownership History

CARFAX defines an owner as an individual or business that possesses and uses a vehicle. Not all title transactions represent changes in ownership. To provide estimated number of owners, CARFAX proprietary technology analyzes all the events in a vehicle history. Estimated ownership is available for vehicles manufactured after 1991 and titled solely in the US including Puerto Rico. Dealers sometimes opt to take ownership of a vehicle and are required to in the following states: Maine, Massachusetts, New Jersey, Ohio, Oklahoma, Pennsylvania and South Dakota. Please consider this as you review a vehicle's estimated ownership history.

Title Issued

A state issues a title to provide a vehicle owner with proof of ownership. Each title has a unique number. Each title or registration record on a CARFAX report does not necessarily indicate a change in ownership. In Canada, a

registration and bill of sale are used as proof of ownership.

Follow Us:



facebook.com/CARFAX



[@CARFAXinc](https://twitter.com/CARFAXinc)



About CARFAX

CARFAX DEPENDS ON ITS SOURCES FOR THE ACCURACY AND RELIABILITY OF ITS INFORMATION. THEREFORE, NO RESPONSIBILITY IS ASSUMED BY CARFAX OR ITS AGENTS FOR ERRORS OR OMISSIONS IN THIS REPORT. CARFAX FURTHER EXPRESSLY DISCLAIMS ALL WARRANTIES, EXPRESS OR IMPLIED, INCLUDING ANY IMPLIED WARRANTIES OF MERCHANTABILITY OR FITNESS FOR A PARTICULAR PURPOSE.

© 2025 CARFAX, Inc., part of S&P Global. All rights reserved.
10/31/25 6:02:17 PM (CDT)

I have reviewed and received a copy of the CARFAX Vehicle History Report for this 2008 BMW M3 vehicle (VIN: WBSVA93548E215810), which is based on information supplied to CARFAX and available as of 10/31/25 at 7:02 PM (EDT).

Customer Signature

Date

Dealer Signature

Date