



BEACONS



A, B, R,
AC & CAA
only



























permanent
mount only

EB7185 SERIES SAE Class I Dual-Color LED

The EB7185 LED beacons offer a long, maintenance free service life and low amp draw, this beacon is a high performance, cost effective choice for many applications. Dual-color amber/clear illumination models are available. Easily replace strobe or rotating beacons with the latest technology so no ongoing maintenance is required.

Models

PART NO.	MOUNT	LENS COLOR	LED COLOR OPTIONS
EB7185AAA	4 Bolt		
EB7185AAA-T13	4 Bolt		
EB7185AAA-VM	Vacuum-Magnet		
EB7185AAA-VM-T13	Vacuum-Magnet		
EB7185CAC-T13	4 Bolt		
EB7185CAC-VM-T13	Vacuum-Magnet		
EB7185CXX	4 Bolt		    
EB7185CXX-VM	Vacuum-Magnet		    

Replace "X" in part number with desired color: A=amber, B=blue, C=clear, G=green, R=red

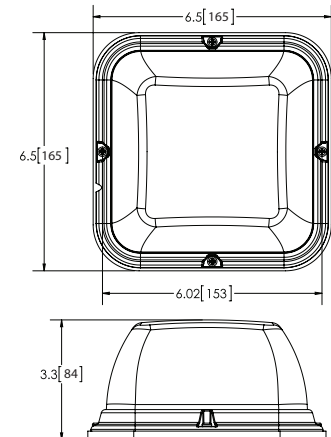

Features and Benefits

- 12-24 VDC, 8.6 FPM
- Dual color warning (CAC models)
- 24 flash patterns, including simulated rotate mode and hi/lo intensity
- Multiple units can be synchronized
- Cigarette plug with on/off and flash pattern switch (vacuum-magnet only)
- Temperature Range: -22°F to +122°F (-30°C to +50°C)