



# MINIBARS























A, B, CA  
& R only

## 5550 Reflex® SAE Class I LED, 11"

5550 Series LED microbars provide a super-compact yet powerful warning solution that offers the flexibility of either permanent or vacuum-magnet mounting. Featuring 12-24 VDC operation, the Reflex microbar uses high intensity LEDs to maximize light output. Users can select from 35 or 91 flash patterns, either via trigger wire on permanent mount models or cigarette plug switch on vacuum-magnet models.

### Models

PART NO.	MOUNT	LENS COLOR	LED COLOR OPTIONS
5550A	4 Bolt		
5550CX	4 Bolt		 
5550CXX	4 Bolt		   
5550A-VM	Vacuum-Magnet		
5550CX-VM	Vacuum-Magnet		 
5550CXX-VM	Vacuum-Magnet		   

Replace "X" in part number with desired color: A=amber, B=blue, C=clear G=green, R=red

### Features and Benefits

- 12-24 VDC, 3.4 Amps
- Four LED reflector modules, each containing 12 LEDs provide high intensity light output
- Choice of 35 flash patterns on single-color or 91 flash patterns on dual-color models
- Cigarette plug with on/off and flash pattern selection switch (vacuum-magnet)
- Polycarbonate base & low profile lens
- Syncable with existing Reflex line of minibars
- Temperature Range: -22°F to +122°F (-30°C to +50°C)

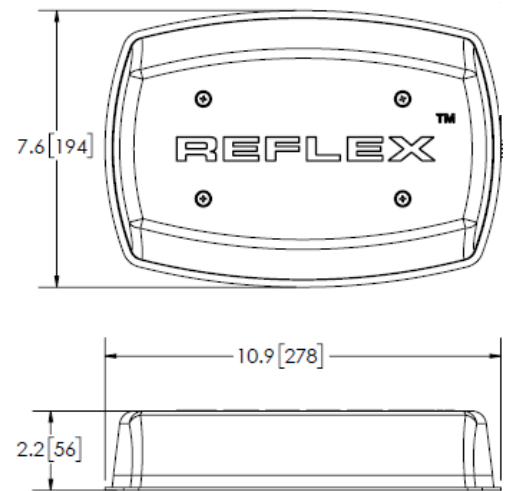

### Accessories / Replacements

- Domes: Amber - R5545LA  
Clear - R5545LC
- Mounting Feet: EZ5500BKT