



LEM4ERG(N)/LEM6ERGL0(N)/FME11ERG/FME33ERGL0

ASSEMBLY INSTRUCTIONS
OPERATING INSTRUCTIONS
WARRANTY









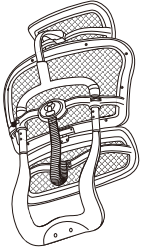
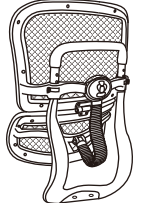
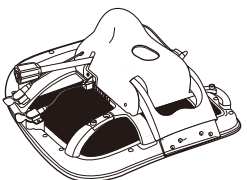
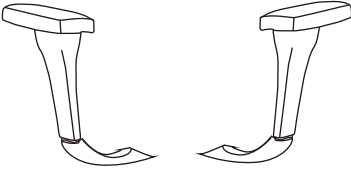

CUSTOMER SERVICE 1-800-637-0005
WWW.EUROTECHSEATING.COM

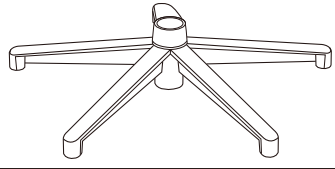
ASSEMBLY INSTRUCTIONS

LEM4ERG(N)/LEM6ERGL0(N)/FME11ERG/FME33ERGL0

Remove all items from the carton. Verify all components before assembly.

Part List				
Key	Description	Part	Qty.	Spare
A	LEM4ERG Backrest		1	
B	LEM6ERGL0 Backrest		1	
C	Seat		1	
D	Armrests (1 left & 1 right armrest)		2	
E	Seat Post(Cylinder)		1	
F	Star Base		1	
G	Caster		5	
H	Type A Arm Bolts (1/4" x 1")		2	1
I	Type B Arm Bolts (1/4" x 5/8")		2	1
J	Back Bolts (M8 X 17mm)		2	1
K	Washers for Arm Bolts (Ø6.5*10.5*1.5mm)		4	2
L	Allen Wrench		1	

• Please tighten your chairs hardware every six months.

ASSEMBLY INSTRUCTIONS

LEM4ERG(N)/LEM6ERGLO(N)/FME11ERG/FME33ERGLO

Remove all items from the carton. Verify all components before assembly.

STEP 1

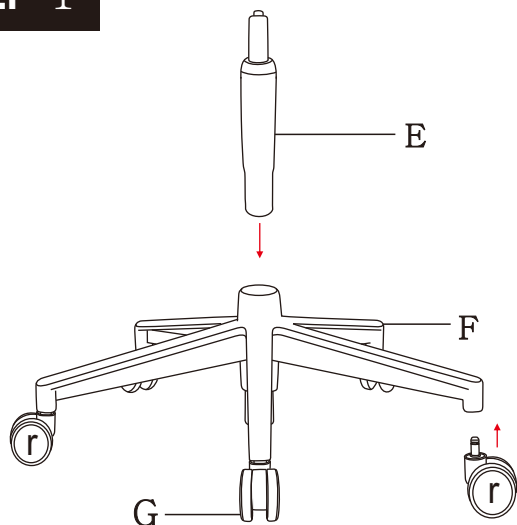

Press the Casters (G) into the holes at the end of each leg of the Base (F).

Insert Seat Post (E) into the center hole of the base (F).

STEP 2

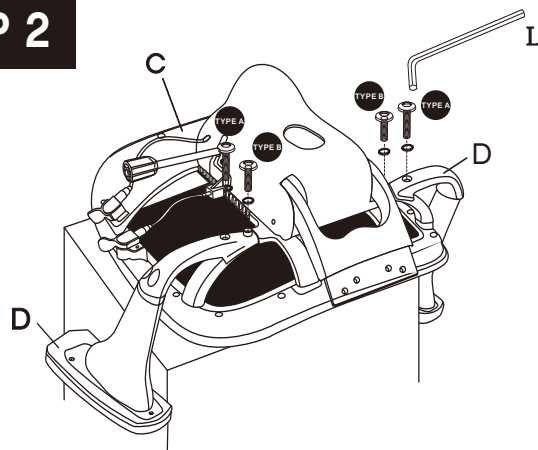

The **Type B Arm Bolt** is shorter and will be inserted into the hole **CLOSER** to the mechanism. The **Type A Arm Bolt** is longer and will be inserted into the hole **FARTHER** away from the mechanism.

For easy assembly, place the Seat Cushion (C) face down on a flat surface. Attach Armrest (D) to the Seat Cushion (C) as shown using 1 Type A Arm Bolt (H) with 1 washer (K) and 1 Type B Arm Bolt (I) with 1 washer (K) on each arm.

Tighten the bolts securely with the enclosed Allen Wrench (L).

STEP 3

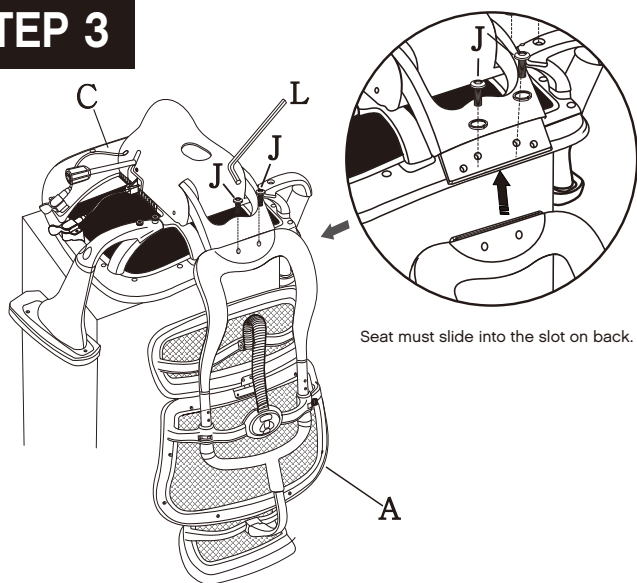

Please be careful to use the correct Back Bolts (J).

Assemble the Backrest (A) to the Seat Cushion (C) using 2 Back Bolts (J).

Tighten the bolts securely with the enclosed Allen Wrench (L).

STEP 4

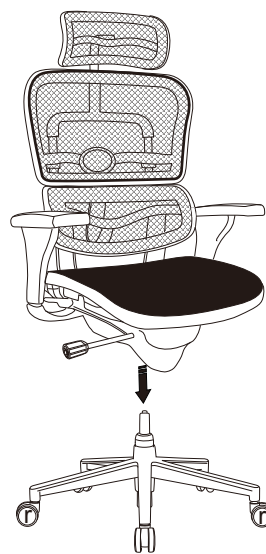

Now turn the assembled seat upright and locate the center hole of the Mechanism over the Seat Post. Push down firmly until the connection is secure.

PREVENTIVE MAINTENANCE AND WARNING!

- USE THIS PRODUCT ONLY FOR SEATING ONE PERSON AT A TIME.
- DO NOT USE THIS CHAIR AS A STEP STOOL / LADDER.
- DO NOT SIT ON ANY PART OF THE CHAIR EXCEPT THE SEAT.
- DO NOT USE CHAIR ON UNEVEN FLOOR SURFACES.
- DO NOT USE CHAIR UNLESS ALL BOLTS, SCREWS AND KNOBS ARE TIGHTENED.
- **EVERY SIX MONTHS, PLEASE MAKE SURE ALL BOLTS, SCREWS AND KNOBS ARE FULLY TIGHTENED TO ENSURE STABILITY.**

- IF ANY PARTS ARE MISSING, BROKEN, DAMAGED OR WORN, STOP USE OF THE PRODUCT UNTIL REPAIRS ARE MADE USING FACTORY AUTHORIZED PARTS.
- DISPOSE OF PACKAGING PROPERLY. PLASTIC BAG IS NOT A TOY. DO NOT USE PLASTIC BAG AS HEAD COVERING – IT MAY CAUSE SUFFOCATION.
- FAILURE TO FOLLOW THESE WARNINGS COULD RESULT IN SERIOUS INJURY.
- NOTE: SOME SCREWS MAY BE PREASSEMBLED. IF PREASSEMBLED, IGNORE ASSEMBLY INSTRUCTIONS.

OPERATING INSTRUCTIONS

LEM4ERG(N)/LEM6ERGLO(N)/FME11ERG/FME33ERGLO

A1 HEADREST HEIGHT ADJUSTMENT

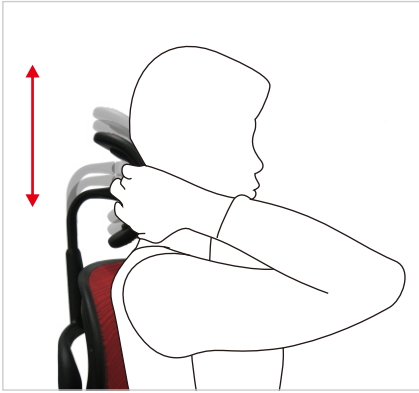

A2 HEADREST ANGLE ADJUSTMENT

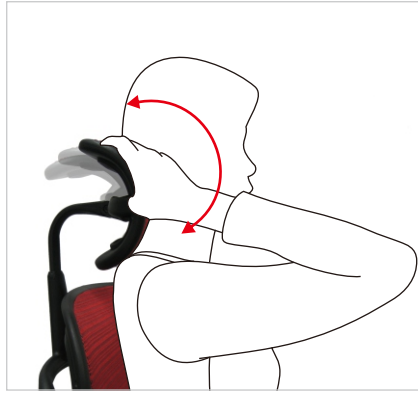

A1 HEADREST HEIGHT ADJUSTMENT

While seated, hold headrest frame and move up or down to adjust height. There are 6 positions with a 1.6" range of adjustment. For LEM4ERG only.

A2 HEADREST ANGLE ADJUSTMENT

While seated, hold the headrest cushion and turn to adjust the angle. The Headrest has a 30° angle adjustment. For LEM4ERG only.

B1 BACKREST TILT ANGLE ADJUSTMENT



B2 BACKREST TENSION ADJUSTMENT



B1 BACKREST TILT ANGLE ADJUSTMENT

While seated, pull the single rod control lever completely backward and lean against the back. When your desired angle is achieved, return the lever to the original middle position to lock your tilt angle into place. There are 3 positions that provide 25° of range.

B2 BACKREST TENSION ADJUSTMENT

While seated, turn the Backrest Tilt Tension Adjustment handle clockwise or counterclockwise to adjust the tilt tension to your preferred level of resistance.

B3 BACKREST HEIGHT ADJUSTMENT

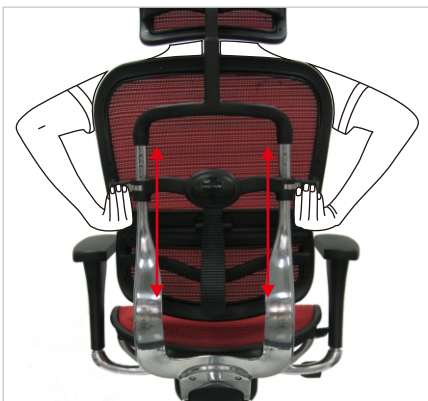

B4 LUMBAR SUPPORT HEIGHT ADJUSTMENT

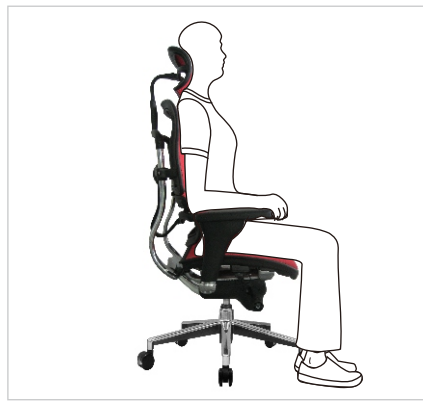

B3 BACKREST HEIGHT ADJUSTMENT

While seated, hold the sides of the backrest handle and move up or down. There is a 1.57" range of adjustment.

B4 LUMBAR SUPPORT HEIGHT ADJUSTMENT

A. The height of the lumbar support can be adjusted by lifting or lowering the backrest height.

B. Suitable height of the lumbar support provides optimum comfort.

OPERATING INSTRUCTIONS

LEM4ERG(N)/LEM6ERGLO(N)/FME11ERG/FME33ERGLO

C1 ARMREST HEIGHT ADJUSTMENT

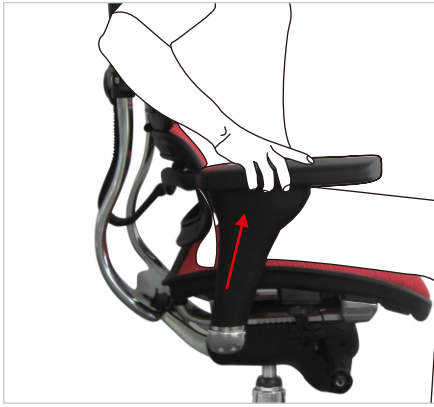

C2 ARM PAD ANGLE ADJUSTMENT

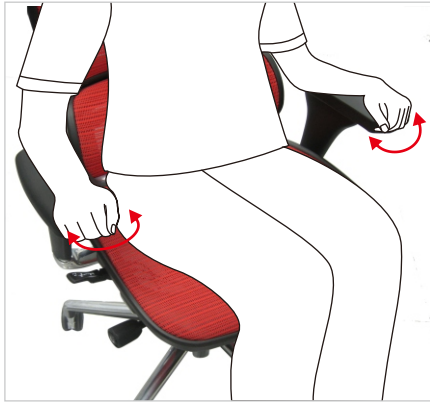

C1 ARMREST HEIGHT ADJUSTMENT

While seated, grasp each armrest and raise to your desired height. In order to lower the arm, lift the armrest to its highest position and it will go back down to the lowest height. Then repeat to get to your desired height. The arm height adjustment range is 3.3".

C2 ARM PAD ANGLE ADJUSTMENT

While seated, a 15° range of movement can be achieved by swiveling the arm pads inward or outward.

C3 ARM PAD FORWARD AND BACKWARD ADJUSTMENT



C3 ARM PAD FORWARD AND BACKWARD ADJUSTMENT

While seated, push the arm pads forward or backward to a desired position. The range of movement is approximately 2".

D1 SEAT HEIGHT ADJUSTMENT

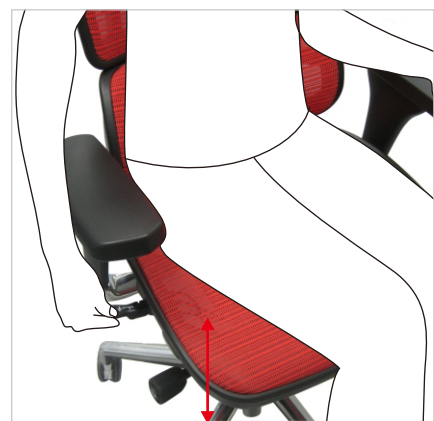

D1 SEAT HEIGHT ADJUSTMENT

While seated, pull the single rod control lever upward and hold it while raising or lowering the seat to reach your desired seat height. When the lever is released to its original position, the seat height is locked. The seat height adjustment range is approximately 3.6".

D2 SEAT DEPTH ADJUSTMENT



D2 SEAT DEPTH ADJUSTMENT

While seated, push the single rod control lever forward to adjust the seat depth. The range of movement for the seat is approximately 1.97". When your desired seat position is achieved, return the lever to the original middle position to lock your seat position into place.

OUR PROMISE.

They say with age comes wisdom. And while we've learned a lot since we sold our first office chair in 1979, even then we knew that superior craftsmanship and design are essential ingredients in delivering real value for our customers. All these years later, those three simple pillars still stand behind our promise of exceptional seating with every chair we sell.

DESIGN CRAFTSMANSHIP VALUE

Eurotech. Sit Smarter.

THE EUROTECH WARRANTY

- For all products except for 24/7 chairs (see below), Eurotech warrants to the original purchaser all components for the life of the product with the exception of upholstery and foam, which will be warranted for five years.
- For 24/7 chairs, Eurotech warrants to the original purchaser of all 24/7 chairs all components for 10 years with the exception of upholstery and foam which will be warranted for 2 years.
- Eurotech warrants to the original purchaser that all parts will be free from material defects. Eurotech will repair or replace, at its option, any unaltered components.
- Eurotech does not warrant any aftermarket hardware that is installed on the product.
- Eurotech's warranty is limited to the normal use of the product in a forty hour work week and a 250lb. weight limit unless otherwise noted.
- Eurotech shall NOT be liable for consequential or incidental damage arising from any product defect.
- Eurotech's warranty is limited to replacement or repair and does not cover cost of transportation and labor. There are no other warranties expressed or implied other than those specifically described.
- Eurotech does not warrant customer's own material.

This warranty is made as of 9/15/16. Please see <http://www.eurotechseating.com/warranty-information> for any updates and/or revisions to this warranty.