

# eurotech

A RAYNOR GROUP COMPANY

## ADAPT-GST-X2

ASSEMBLY INSTRUCTIONS  
OPERATING INSTRUCTIONS  
WARRANTY

---

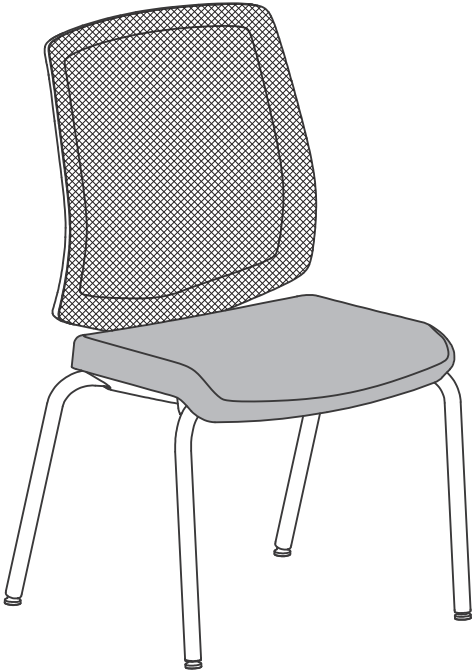

---





CUSTOMER SERVICE: [parts@raynorgroup.com](mailto:parts@raynorgroup.com)  
CUSTOMER SERVICE: 1-800-637-0005  
[www.eurotechseating.com](http://www.eurotechseating.com)

# ASSEMBLY INSTRUCTIONS

## ADAPT-GST-X2

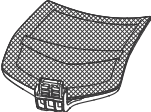
Remove all items from the carton. Verify all pieces before assembly.

### PARTS LIST

Key	Description	Part	Qty.	Spare
A	Back Cushion		1 pc	
B	Seat Cushion with Base		1 pc	
C	Back Screws M8*16mm, Blue		4 pcs	1pc
D	Allen Wrench		1 pc	

### PREVENTIVE FACINTENANUE AND WARNING!

- USE THIS PRODUCT ONLY FOR SEATING ONE PERSON AT A TIME.
- DO NOT USE THIS CHAIR AS A STEP STOOL / LADDER.
- DO NOT SIT ON ANY PART OF THE CHAIR EXCEPT THE SEAT.
- DO NOT USE CHAIR ON UNEVEN FLOOR SURFACES.
- DO NOT USE CHAIR UNLESS ALL BOLTS, SCREWS AND KNOBS ARE TIGHTENED.
- EVERY SIX MONTHS, PLEASE MAKE SURE ALL BOLTS, SCREWS AND KNOBS ARE FULLY TIGHTENED TO ENSURE STABILITY.
- IF ANY PARTS ARE MISSING, BROKEN, DAMAGED OR WORN, STOP USE OF THE PRODUCT UNTIL REPAIRS ARE MADE USING FACTORY AUTHORIZED PARTS.
- DISPOSE OF PACKAGING PROPERLY. PLASTIC BAG IS NOT A TOY. DO NOT USE PLASTIC BAG AS HEAD COVERING — IT MAY CAUSE SUFFOCATION.
- FAILURE TO FOLLOW THESE WARNINGS COULD RESULT IN SERIOUS INJURY.
- NOTE: SOME SCREWS MAY BE PREASSEMBLED. IF PREASSBABLED, IGNORE ASSEMBLY INSTRUCTIONS.

# ASSEMBLY INSTRUCTIONS

## ADAPT-GST-X2

Remove all items from the carton. Verify all pieces before assembly.

### STEP 1

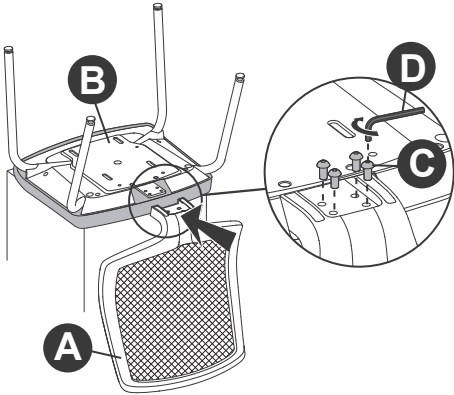

Assemble Backrest (A) to Seat Cushion (B) and secure in place using 4 Back Screws (C) as shown. Tighten the screws fully with Allen Wrench (D)

### STEP 2

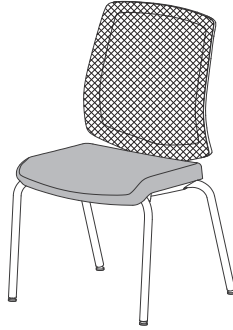

Before using your Chair, ensure that all the bolts are tightened fully for safety. You can now enjoy the confort of your new chair.

NOTE: Please keep the Allen wrench and check all bolts periodically to ensure these remain tightly fastened.

### IMPORTANT FOR YOUR SAFETY!

During assembly, make sure to tighten all bolts completely to ensure that back is fastened properly. Also, after assembly, check bolts regularly to make sure that they remain completely tightened.

### PREVENTIVE FACINTENANUE AND WARNING!

- USE THIS PRODUCT ONLY FOR SEATING ONE PERSON AT A TIME.
- DO NOT USE THIS CHAIR AS A STEP STOOL / LADDER.
- DO NOT SIT ON ANY PART OF THE CHAIR EXCEPT THE SEAT.
- DO NOT USE CHAIR ON UNEVEN FLOOR SURFACES.
- DO NOT USE CHAIR UNLESS ALL BOLTS, SCREWS AND KNOBS ARE TIGHTENED.
- EVERY SIX MONTHS, PLEASE MAKE SURE ALL BOLTS, SCREWS AND KNOBS ARE FULLY TIGHTENED TO ENSURE STABILITY.
- IF ANY PARTS ARE MISSING, BROKEN, DAMAGED OR WORN, STOP USE OF THE PRODUCT UNTIL REPAIRS ARE MADE USING FACTORY AUTHORIZED PARTS.
- DISPOSE OF PACKAGING PROPERLY. PLASTIC BAG IS NOT A TOY. DO NOT USE PLASTIC BAG AS HEAD COVERING — IT MAY CAUSE SUFFOCATION.
- FAILURE TO FOLLOW THESE WARNINGS COULD RESULT IN SERIOUS INJURY.
- NOTE: SOME SCREWS MAY BE PREASSEMBLED. IF PREASSBABLED, IGNORE ASSEMBLY INSTRUCTIONS.

# OUR PROMISE.

They say with age comes wisdom. And while we've learned a lot since we sold our first office chair in 1979, even then we knew that superior craftsmanship and design are essential ingredients in delivering real value for our customers. All these years later, those three simple pillars still stand behind our promise of exceptional seating with every chair we sell.

## DESIGN CRAFTSMANSHIP VALUE

Eurotech. Sit Smarter.

---

## THE EUROTECH WARRANTY

- For all products except for 24/7 chairs (see below), Eurotech warrants to the original purchaser all components for the life of the product with the exception of upholstery and foam, which will be warranted for five years.
- For 24/7 chairs, Eurotech warrants to the original purchaser of all 24/7 and Big & Tall chairs all components for 5 years with the exception of upholstery and foam which will be warranted for 2 years.
- Eurotech warrants to the original purchaser that all parts will be free from material defects. Eurotech will repair or replace, at its option, any unaltered components.
- Eurotech does not warrant any aftermarket hardware that is installed on the product.
- Eurotech's warranty is limited to the normal use of the product in a forty hour work week and a 275lb. weight limit unless otherwise noted.
- Eurotech shall NOT be liable for consequential or incidental damage arising from any product defect.
- Eurotech's warranty is limited to replacement or repair and does not cover cost of transportation and labor. There are no other warranties expressed or implied other than those specifically described.
- Eurotech does not warrant customers own material.
- Eurotech warrants to the original purchaser with proof of purchase along with a copy of the receipt.
- Arm Pads are warranted for 2 years under normal wear and tear.
- Cylinder is warranted for 5 years.

This warranty is made as of 9/15/16. Please see <http://www.eurotechseating.com/warranty-information> for any updates and/or revisions to this warranty.